

# BOHRWERKZEUGE



# MITSUBISHI MATERIALS

## GESAMTKATALOG C010

2025 – 2027

### GEZIELT, KOMPAKT, HANDLICH:

Der neue Gesamtkatalog präsentiert nun das umfangreiche Produktsortiment von Mitsubishi Materials in einzelnen Anwendungsbereichen, um Nutzer einen schnelleren, individuellen Informationszugriff zu gewährleisten.

Eine Katalogsammlung im praktischen Kleinformat, die aus den folgenden fünf Bänden besteht:

- DREHWERKZEUGE
- BOHRWERKZEUGE
- VOLLHARTMETALL-FRÄSWERKZEUGE
- WENDEPLATTEN-FRÄSWERKZEUGE
- MPLUS

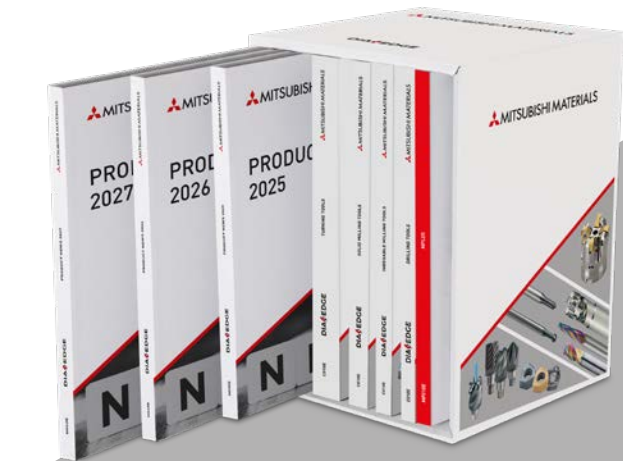

EINFACHE HANDHABUNG

MEHR FLEXIBILITÄT

INZELNE ANWENDUNGSBEREICHE

Der mitgelieferte Schubler erleichtert die Aufbewahrung der Bücher und bietet Platz für alle weiteren Kataloge, die im Zeitraum 2025 – 2027 veröffentlicht werden, wie beispielsweise die Produktneuheiten.

Fügen Sie die ergänzenden Kataloge in den vorgesehenen Platz im Schubler hinein, um die Sammlung zu erweitern oder ersetzen Sie ggf. die Kataloge durch die neuen Ausgaben.

### HINWEISE:

- Mit Erscheinen dieses Katalogs verlieren alle bisherigen Gesamt- und Neuheiten-Kataloge ihre Gültigkeit.
- Die Produktneuheiten erscheinen zweimal im Jahr, jeweils im April und Oktober.
- Der neue Gesamtkatalog kann nur als komplette Katalogsammlung (fünf Bände) bestellt werden.

**Bestellnummer: C010D**



### DIGITALE VERSION

Für die digitale Version des Kataloges scannen Sie bitte den QR Code oder besuchen Sie unseren mediastore: [www.mhg-mediastore.net](http://www.mhg-mediastore.net)

Besuchen Sie bitte auch:  
[www.mmc-carbide.com](http://www.mmc-carbide.com)

# BOHR- WERKZEUGE



## **LEISTUNG – NEUDEFINITION DER PARAMETER**

Die Dynamik der modernen Fertigungsindustrie ist für Mitsubishi Materials ein ständiger Ansporn, im Markt an vorderster Stelle zu stehen.

Im alltäglichen Austausch mit Partnern und Kunden werden Lösungen für jede Situation angeboten.

Ob Wendepplattenbohrer der Serie MVX für Bohrtiefen bis zu 6xD oder Tieflochbohrer der MPS1-Serie, Mitsubishi Materials bietet individuelle Lösungen für alle Bohranwendungen.

# DIA EDGE



 MITSUBISHI MATERIALS

# INHALT

## BOHRWERKZEUGE

BOHRWERKZEUGE	M001
ERSATZTEILE	N001
TECHNISCHE INFORMATIONEN	P001
INHALTSVERZEICHNIS	1
ALLGEMEINE INFORMATIONEN	



# ALLGEMEINE ERKLÄRUNG: BOHRWERKZEUGE

● Wie sind die Seiten dieses Kapitels aufgebaut

① Sortiert nach Bohranwendung.

**PRODUKTFOTO**

**PRODUKT**

**PRODUKTBEZEICHNUNG**

**DURCHMESSER TOLERANZ**

**PRODUKTBEZEICHNUNG**

**ABBILDUNG**

### MPS1

4-Fasen & Super Long-VHM-Bohrer

● Neue PVD-Beschichtung auf AT/CrN-Basis.  
● 4-Fasen-Schneidrand für optimale Spannkontrolle.  
● Bohrerschaft mit optimalem Rundlauf und Wiederholgenauigkeit.  
● Einfacher WSP-Testsch.

Interne Kühlung

● Typ 1 Zylinderschaft mit konischem Hinterschiff

MPS1-SL-DIN-C/LRC-L40C

● Typ 3 Whistle Notch Schaft mit konischem Hinterschiff

MPS1-SL-DIN (Whistle notch)

DC (mm)	Bestellnummer	LU	LCP	LH	DAL	LF	Typ
3	MPS1-0300S-DIN	15,0	19,0	24,0	61,0	61,0	3
3	MPS1-0300S-DIN-C	15,0	19,0	24,0	61,0	61,0	3
5	MPS1-0300L-DIN	20,0	24,0	28,0	65,0	65,0	3
5	MPS1-0300L-DIN-C	20,0	24,0	28,0	65,0	65,0	3
5	MPS1-0300-PC	6,0	16,0	19,0	55,0	55,0	3
8	MPS1-0300-LRC	24,0	33,0	38,0	78,0	78,0	6
10	MPS1-0300-L10C	30,0	37,0	42,0	78,0	78,0	6
12	MPS1-0300-L12C	36,0	43,0	48,0	85,0	85,0	6
15	MPS1-0300-L15C	45,0	52,0	57,0	94,0	94,0	6
20	MPS1-0300-L20C	60,0	67,0	72,0	103,0	103,0	6
25	MPS1-0300-L25C	75,0	82,0	87,0	124,0	124,0	6
30	MPS1-0300-L30C	90,0	97,0	102,0	139,0	139,0	6
35	MPS1-0300-L35C	105,0	112,0	117,0	158,0	158,0	6
40	MPS1-0300-L40C	120,0	128,0	133,0	173,0	173,0	6

● Lagerstandard. □: Herstellung nur auf Anfrage.

SCHNITTZEICHENUNGEN > M071  
ANWENDUNGSHINWEISE > M072  
TECHNISCHE DATEN > P001

### BOHREN (SCHNEIDKRONEN AUSFÜHRUNG)

TAW

● Wälzformige Schneidkanten für optimale Spannkontrolle.  
● Hochleistungs-PC-Beschichtung für optimalen Rundlauf und Wiederholgenauigkeit.  
● Einfacher WSP-Testsch.

Halter für Schneidkronen

DC (mm)	Bestellnummer	LU	LCP	LH	DAL	LF	Typ
3	TAWSN1900S25	58,0	71,0	102,0	158,0	155,0	25
5	TAWWN1900S25	95,0	110,0	137,0	193,0	190,0	25
8	TAWLN1900S25	151,0	165,0	188,0	244,0	241,0	25
3	TAWSN2000S25	62,0	75,0	102,0	158,0	155,0	25
5	TAWWN2000S25	101,0	116,0	142,0	198,0	195,0	25
8	TAWLN2000S25	159,0	173,0	196,0	252,0	249,0	25

Hinweis 1) Die obigen Abmessungen (\*) beziehen sich für montierte Schneidplatten auf Grundkörper.  
Hinweis 2) Bei Bedarf von abweichenden Geometrien setzen Sie sich mit uns in Verbindung.  
(Andere Durchmesser und Längen können bestellt werden).

● Lagerstandard. □: Herstellung nur auf Anfrage  
(Verpackungseinheit: 15Stk.)

**STANDARDPRODUKTE**  
Beinhaltet Durchmesser, Bohrlängen, Bestellnummern, Lagerstatus, Abmessungen und Ersatzteile.

**LEGENDE FÜR LAGERSYMBOL**  
Wird auf jeder Doppelseite auf der linken Seite gezeigt.

# BOHRWERKZEUGE

BOHRER KLASSIFIZIERUNG .....	M002
SYMBOLBESCHREIBUNG .....	M003
BOHRERAUSWAHL .....	M004

## BOHRER STANDARD

### VOLLHARTMETALL

MSE .....	[Mikro-VHM-Bohrer] .....	M008
MSP .....	[Zentrierbohrer] .....	M011
DLE .....	[Vollhartmetallbohrer zum Zentrieren und Anfasen] .....	M012
MINI-MFE .....	[Vollhartmetall-Flachbohrer] .....	M018
<b>NEW</b> DFAS .....	[Vollhartmetall-Flachbohrer] .....	M020
<b>NEW</b> DVAS .....	[Vollmetallhartbohrer der TRISTAR-Serie] .....	M033
MINI-DWAE .....	[Für Langdreh- und kleine CNC-Drehautomaten] .....	M024
DWAE .....	[Für Langdreh- und kleine CNC-Drehautomaten] .....	M025
MINI-MVS .....	[4-Fasen-VHM-Bohrer mit interner Kühlmittelzufuhr] .....	M049
MINI-MWS .....	[2-Fasen-VHM-Bohrer mit interner Kühlmittelzufuhr] .....	M053
MPS1 .....	[4-Fasen & Super Long-VHM-Bohrer] .....	M057
MICRO-MGS .....	[Mikro-VHM-Einlippenbohrer mit interner Kühlmittelzufuhr] ..	M075
MMS .....	[VHM-Bohrer für rostfreien Stahl] .....	M078
DSAS .....	[VHM-Bohrer für hitzebeständige Legierungen] .....	M092
MNS .....	[VHM-Bohrer mit 4 Kühlkanälen für Aluminium] .....	M098
MAE/MAS .....	[VHM-Präzisionsbohrer für Aluminium] .....	M122
MHS .....	[VHM-Präzisionsbohrer für gehärteten Stahl] .....	M128

### DIAMANTBESCHICHTETER VHM-BOHRER

MCC .....	[Für CNC-Maschine/CFK] .....	M186
MCA .....	[Für CNC-Maschine/CFK + Al] .....	M187
MCT .....	[Für CNC-Maschine/CFK + Ti] .....	M188
MCW .....	[Für CNC-Maschine/CFK und Schichtverbundmaterial – Hochpräzision] ..	M189
MCCH .....	[Für Handwerkzeuge/CFK] .....	M190
MCAH .....	[Für Handwerkzeuge/CFK + Al] .....	M191

### WSP-AUSFÜHRUNG

STAW .....	[Kronenbohrer für kleine Durchmesser] .....	M139
TAW .....	[Kronenbohrer für allgemeines Bohren] .....	M148
MVX .....	[WSP-Bohrer für hohe Stabilität] .....	M158
VERSTELLHÜLSEN .....		M170

### HSS-BOHRER

#### VIOLET (HSS)

VAPDS .....	[HSS-Co Kurzer Bohrer für Stahl] .....	M172
VAPDM .....	[HSS-Co Mittellanger Bohrer für Stahl] .....	M177
VSD .....	[HSS Langer Bohrer für rostfreien Stahl] .....	M181
VAPDSCB .....	[HSS-Co Bohrer zum Aufbohren] .....	M183

## REIBAHLEN-STANDARD

### MODULARER REIBKOPF

<b>NEW</b> RX1S .....	[Modularer Reibkopf] .....	M195
-----------------------	----------------------------	------

\*Alphabetisches Inhaltsverzeichnis

M012 DLE	M188 MCT	M011 MSP
M020 DFAS	M189 MCW	M158 MVX
M092 DSAS	M128 MHS	M166 MVX (WSP)
M033 DVAS	M075 MICRO-MGS	M139 STAW
M025 DWAE	M024 MINI-DWAE	M142 STAW (WSP)
M170 JFS (HÜLSE)	M018 MINI-MFE	M148 TAW
M122 MAE	M049 MINI-MVS	M153 TAW (WSP)
M122 MAS	M053 MINI-MWS	M177 VAPDM
M187 MCA	M078 MMS	M172 VAPDS
M191 MCAH	M098 MNS	M183 VAPDSCB
M186 MCC	M057 MPS1	M181 VSD
M190 MCCH	M008 MSE	

M195 RX1S



M001

# BOHRER KLASSIFIZIERUNG

## BOHRER KLASSIFIZIERUNG

BOHREN

**MV**

**S**

**0300**

**X**

**S**

Bohrer Bezeichnung	Kühlmittelzufuhr	Durchmesser	L/D	Schaftdurchmesser
<b>DLE</b> : DLE Bohrer <b>DFA</b> : DFAS Bohrer <b>DSA</b> : DSAS Bohrer <b>DWA</b> : DWAE Bohrer <b>MPS1</b> : MPS1 Bohrer <b>MV</b> : MVS Bohrer <b>MW</b> : MWS Bohrer <b>MF</b> : MFE Bohrer <b>MG</b> : MGS Bohrer <b>MA</b> : MAE/MAS Bohrer <b>MS</b> : MSE Bohrer <b>MM</b> : MMS Bohrer <b>MN</b> : MNS Bohrer <b>MH</b> : MHS Bohrer <b>MC</b> : MC Bohrer	<b>E</b> : Externe Kühlung <b>S</b> : Interne Kühlung	<b>z.B</b> <b>0050</b> → Ø 0.5 <b>0300</b> → Ø 3.0	<b>S</b> : 2D <b>M</b> : 3D <b>L</b> : 5D (MAE/MAS Bohrer - 6 x D) <b>L8C</b> : 8D <b>L10C</b> : 10D <b>L12C</b> : 12D <b>L15C</b> : 15D <b>L20C</b> : 20D <b>L25C</b> : 25D <b>L30C</b> : 30D <b>L40C</b> : 40D <b>X</b> : 12D <b>X8DB</b> : 8D <b>X10DB</b> : 10D <b>X15DB</b> : 15D <b>X20DB</b> : 20D <b>X25DB</b> : 25D <b>X30DB</b> : 30D	<b>A</b> : Schaftdurchmesser = Bohrerdurchmesser <b>B</b> : Schaftdurchmesser siehe Katalogdaten <b>C</b> : Zylinderschaft <b>S***</b> : Schaftdurchmesser

\* Abweichungen sind teilweise möglich.

**VA**

**PD**

**S**

**D0050**

Bohrer Bezeichnung	Anwendung	Länge der Bohrnut	Durchmesser
<b>VA</b> : Violet beschichteter Präzisions - Bohrer (Hochwertige Sorte für den Einsatz bei hohen Drehzahlen) <b>V</b> : Violet Bohrer	<b>SD</b> : Zylindrischer Bohrer für allgemeine Zwecke <b>PD</b> : Für Hochpräzisions-bearbeitung	<b>S</b> : Kurz <b>M</b> : Mittel	<b>z.B</b> <b>D0300</b> → Ø 3.0 <b>D0050</b> → Ø 0.5

\* Abweichungen sind teilweise möglich.

**DVA**

**S**

**0100**

**X50**

**S040**

Anwendung	Kühlung	Durchmesser	L/D	Schafttyp
<b>DVA</b> : Allgemeine Bearbeitung	<b>S</b> : Interne Kühlung	<b>0100</b> → Ø 1.0mm <b>0290</b> → Ø 2.9mm	<b>X50</b> : L/D=50 <b>X02</b> : L/D=2	<b>S040</b> : Schaftdurchmesser 4mm



# SYMBOLBESCHREIBUNG

## Schneidstoff



**Ultrafeinkörniges Hartmetall**



**Hochleg. HSS**



**HSS**

## Kern Anschlag



**X Kern Anschlag**



**Z Kern Anschlag**



**XR Kern Anschlag**



**N Kern Anschlag**

## Toleranz



**Bohrerdurchmessertoleranz**



**Schaftdurchmessertoleranz**

## Kühlmittelezufuhr



**Mit Kühlmittelzufuhr**

## Anwendungsbereich Materialien

### 1. Empfehlung



### Keine Empfehlung



## Beschichtet



### MIRACLE-Beschichtung

Original MIRACLE-Beschichtung (AlTiN), auch für Trockenbearbeitung einsetzbar.



### PVD-Beschichtung

DP102A ist ein PVD-beschichteter Hartmetallbohrer für kleine Bohrer Durchmesser mit verbesserter Verschleißfestigkeit.



### PVD-Beschichtung

Der Bohrer zeichnet sich durch seine herausragende Verschleißfestigkeit für eine Vielzahl unterschiedlicher Stähle, Gusseisenwerkstoffe und Aluminiumlegierungen aus.



### PVD-Beschichtung

Das feinkörnige Hartmetall eignet sich hervorragend für rostfreie Stähle und zeichnet sich dank der PVD-Beschichtung durch seine herausragende Wärmebeständigkeit und Schmierfähigkeit aus.



### PVD-Beschichtung

Die DP9020 vereint hohe Verschleiß- und Bruchfestigkeit zu einer längeren Werkzeugstandzeit.



### VIOLET-Beschichtung

Verbesserte Standzeit um den Faktor 2–3 im Vergleich zu TiN-beschichteten Produkten.



### CVD-Diamantbeschichtung

Die einzigartige Feinstkorn-Diamantkristallbeschichtung verbessert erheblich den Verschleißwiderstand und reduziert die Oberflächenrauigkeit.

## Winkel und scharfe Schneidkante



### Spitzenwinkel

Bezeichnet den Bohrwinkel an der Spitze.















M

BOHREN

# BOHRER-AUSWAHL

M

BOHREN

Schneidstoff	Verfügbare Größen	Bohrtiefe (L/D)	Bezeichnung	Kühlung	Beschichtet	Material						Form	Seitenverweis	
						P	M	K	N	S	H		Abmessungen	Schnittbedingungen
						C. Stahl, leg. Stahl	Rostfreier Stahl	Guss	Leichtmetalle	Hitzebeständiger Stahl	Gehärteter Stahl			
Vollhartmetall	Ø 0.1 - Ø 0.99	5-12	<b>MSE</b>	Extern	VP	○	○	○	○	○			M008	M009
	MSP = Pilotbohrer für MSE													
	Ø 1.0 - Ø 16.0	-	<b>DLE</b>	Extern	DP1 DP1A	○	○	○					M012	M016
	SIG=60°, 90°, 120°, 145°													
	Ø 0.75 - Ø 2.95	2	<b>MINI-MFE</b>	Extern	DP1A	○	○	○	○				M018	M019
	Ø 3.0 - Ø 14.0	3	<b>DFAS</b>	Intern	DP1A	○	○	○	○	○			M020	M023
	Ø 1.0 - Ø 2.9	2-50	<b>DVAS</b>	Intern	DP1	○	○	○	○	○			M033	M037
	Ø 1.0 - Ø 2.9	2,4	<b>MINI-DWAE</b>	Extern	DP1A	○	○	○					M024	M031
	Ø 3.0 - Ø 14.0	2,4	<b>DWAE</b>	Extern	DP1A	○	○	○					M025	M031
	Ø 1.0 - Ø 2.9	2*-30	<b>MINI-MVS</b>	Intern	DP1	○	○	○	○	○			M049	M051
	Ø 0.5 - Ø 0.99	1-12	<b>MINI-MWS</b>	Intern	VP	○	○	○	○	○			M053	M055
	Ø 3.0 - Ø 20.0	3-40	<b>MPS1</b>	Intern	DP1	○	○	○					M057	M072
	MPS1-xxxx-PC=Pilotbohrer für MPS1													
	Ø 0.95 - Ø 12.0	1-30	<b>MHS</b>	Intern	VP	○	○			○	○		M128	M136
Ø 3.0 - Ø 20.0	3,5	<b>MMS</b>	Intern	DP7		○						M078	M090	
Ø 3.0 - Ø 15.0	3,5	<b>DSAS</b>	Intern	DP9					○			M092	M097	
Ø 0.7 - Ø 3.0	-80	<b>MICRO-MGS</b>	Intern	-	○	○	○	○				M075	M076	

2\* = Pilotbohrer: Toleranz +0.014 und Bohrtiefe DCx2.

Schneidstoff	Verfügbare Größen	Bohrtiefe (L/D)	Bezeichnung	Kühlung	Beschichtet	Material						Form	Seitenverweis	
						P	M	K	N	S	H		Abmessungen	Schnittbedingungen
						C. Stahl, leg. Stahl	Rostfreier Stahl	Guss	Leichtmetalle	Hitzebeständiger Stahl	Gehärteter Stahl			
Vollhartmetall	Ø 3.0 – Ø 16.0	3	<b>MAE</b>	Extern	–			○	○				M122	M127
	Ø 3.0 – Ø 16.0	3, 6	<b>MAS</b>	Intern	–			○	○				M122	M127
	Ø 3.0 – Ø 20.0	3–30	<b>MNS</b>	Intern	–				○				M098	M118
	Ø 4.76 – Ø 11.14	3	<b>MCC</b>	Extern		Für CFK							M186	M186
	Ø 6.38 – Ø 9.55	5	<b>MCA</b>	Intern		Für CFK + Al							M187	M187
	Ø 6.38 – Ø 9.55	5	<b>MCT</b>	Intern	–	Für CFK + Ti							M188	M188
	Ø 6.38 – Ø 9.55	5	<b>MCW</b>	Intern		Für CFK und Schichtverbundmaterial – Hochpräzision							M189	M189
	Ø 2.5 – Ø 9.55	2–15	<b>MCCH</b>	Extern	–	Für CFK							M190	Handwerkzeug-Anleitung
	Ø 2.5 – Ø 9.55	3–15	<b>MCAH</b>	Extern	–	Für CFK + Al							M191	Handwerkzeug-Anleitung
Hochgeschwindigkeitsstahl	Ø 0.5 – Ø 13.0	2–3	<b>VAPDS</b>	Extern		○	○	○					M172	M176
	Ø 0.5 – Ø 32.0	3–6	<b>VAPDM</b>	Extern		○	○	○					M177	M180
	Ø 0.5 – Ø 13.0	3–6	<b>VSD</b>	Extern		○	○						M181	M182
	Ø 2.0 – Ø 32.0	2–3	<b>VAPDSCB</b>	Extern		○	○	○					M183	M185
WSP-Ausführung	Ø 10.0 – Ø 18.4	1.5–8	<b>STAW</b>	Intern		○	○	○					M139	M144
	Ø 18.5 – Ø 30.4	3–8	<b>TAW</b>	Intern		○	○	○					M148	M155
	Ø 17.0 – Ø 63.0	2–6	<b>MVX</b>	Intern	–	○	○	○		○			M158	M167

◎ : 1. Empfehlung / ○ : 2. Empfehlung

M

BOHREN

# BOHRERSERIE

VOLLHARTMETALL

**MPS1 (4-Fasenbohrer)**

1. Empfehlung

**P M K N S H**

2. Empfehlung

**P M K N S H**

**M**

**BOHREN**

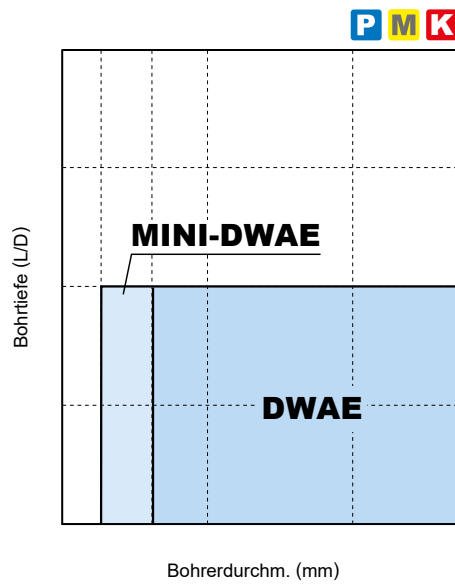
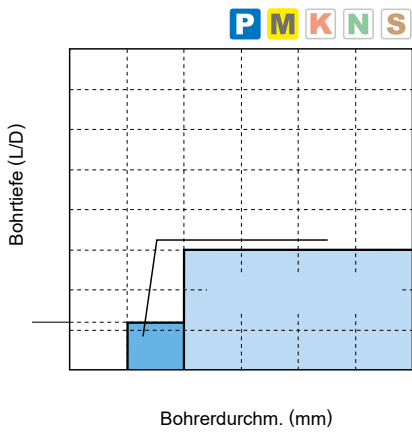
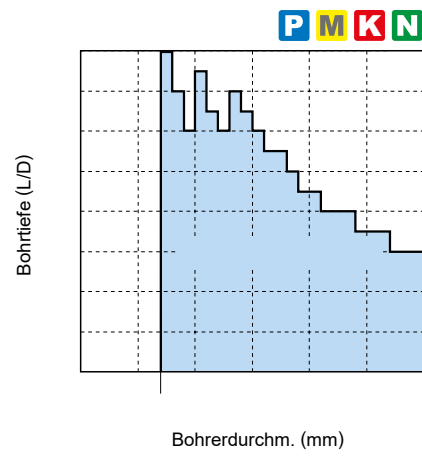
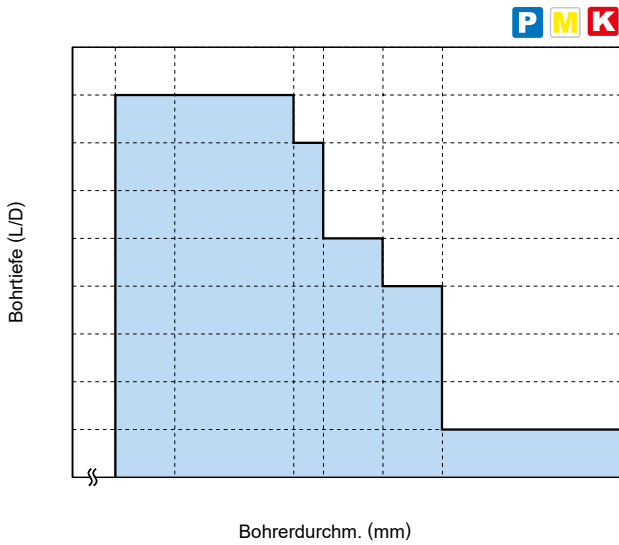

**DVAS NEW**

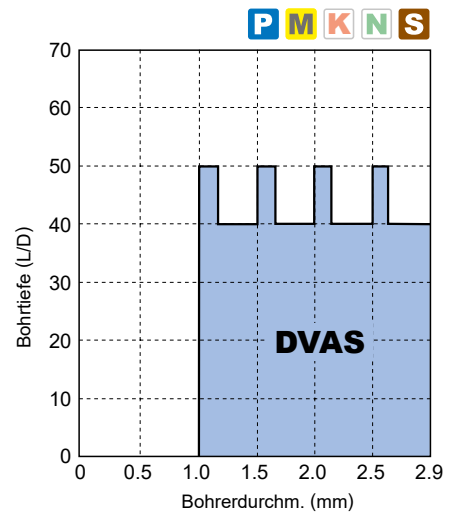

**DFAS**

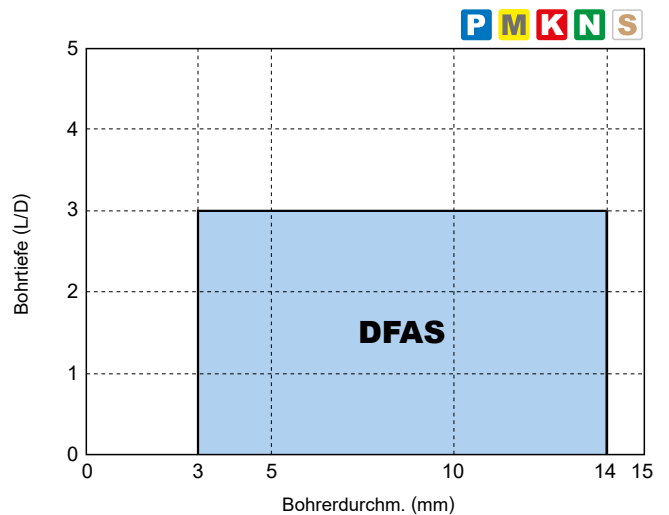
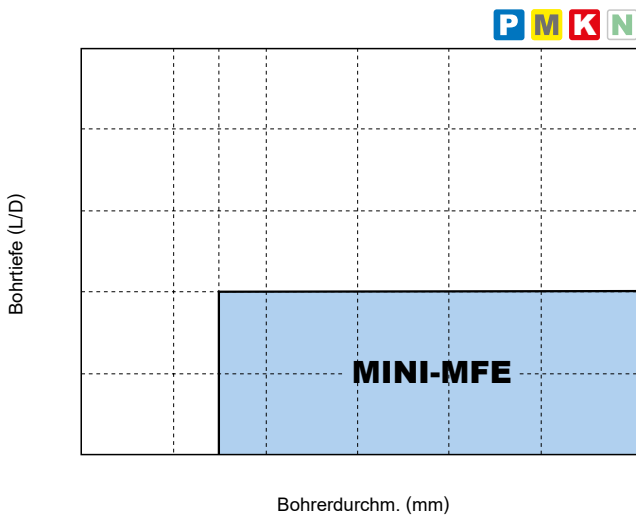

1. Empfehlung

**P M K N S H**

2. Empfehlung

**P M K N S H**

### VOLLHARTMETALL

## MMS (Für rostfreien Stahl)

**M**

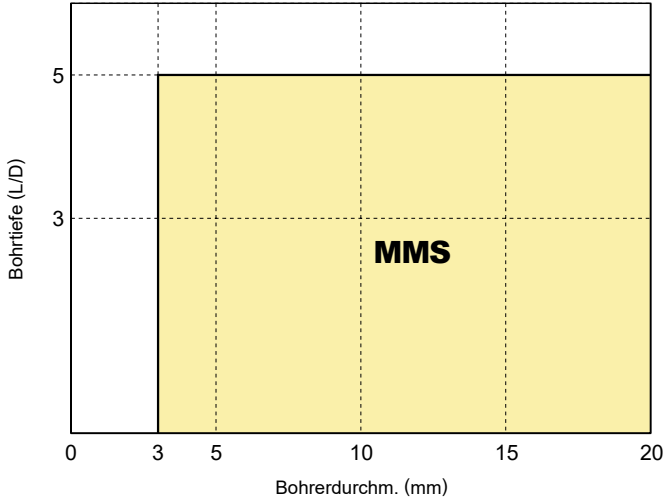

## DSAS (Für die Bearbeitung hitzebeständiger Legierungen)

**S**

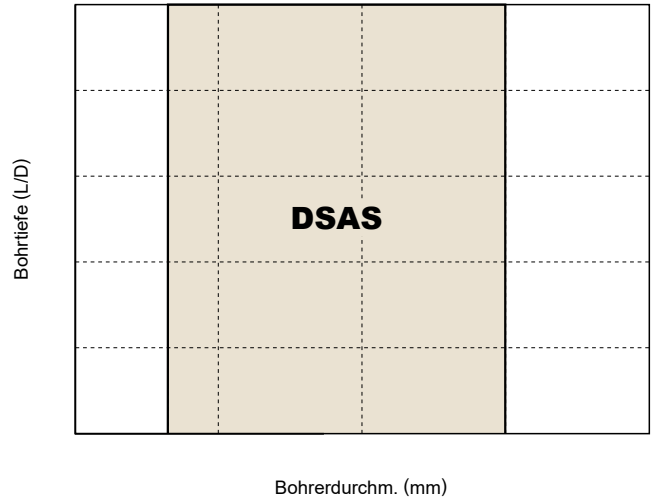

**M**  
BOHREN

## MNS (Für die Bearbeitung von Aluminiumlegierungen)

**N**

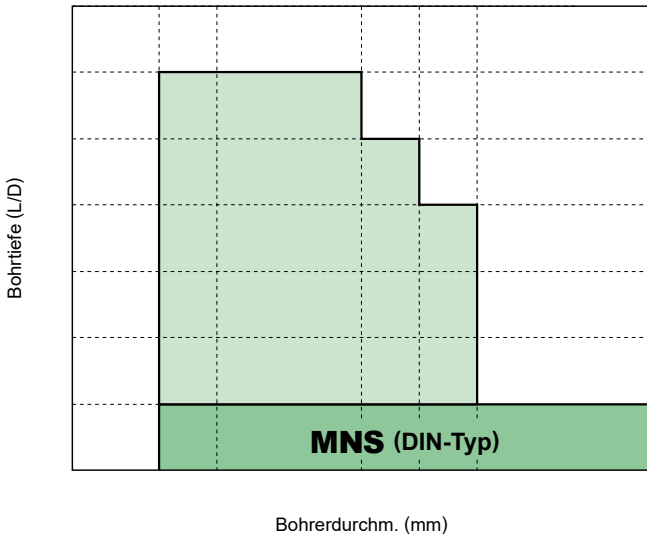

## MHS (Für den Werkzeug- und Formenbau)

**P M S H**

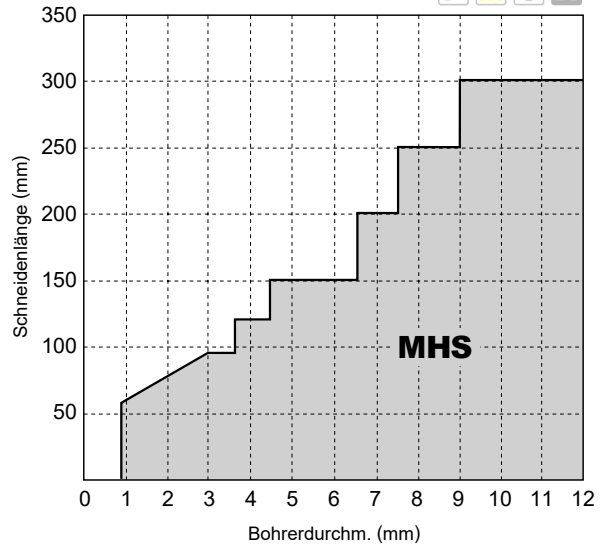

## WSP-AUSFÜHRUNG

**P M K**

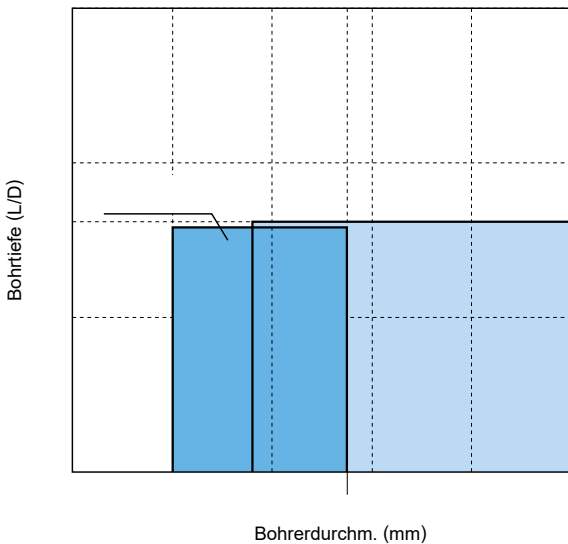

**P M K N H**

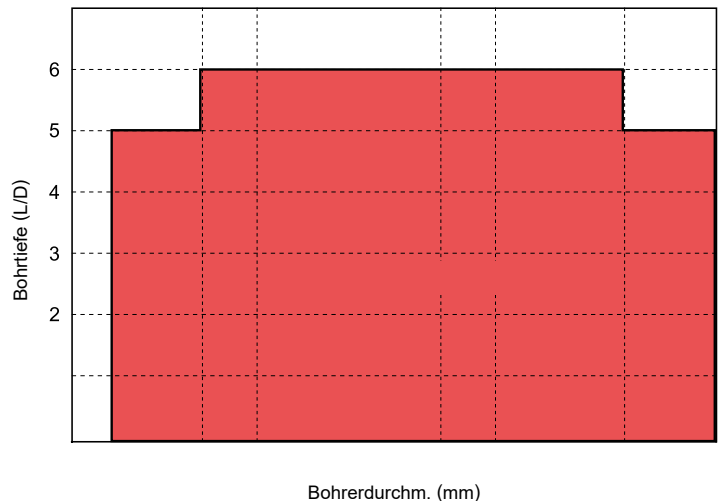

# BOHREN (VOLLHARTMETALL)

# MSE

- Große Spannuten für optimale Spanabfuhr.
- Effiziente Bearbeitung kleinster Bohrungen.



- P
- M
- K
- N
- S
- H

Externe Kühlung

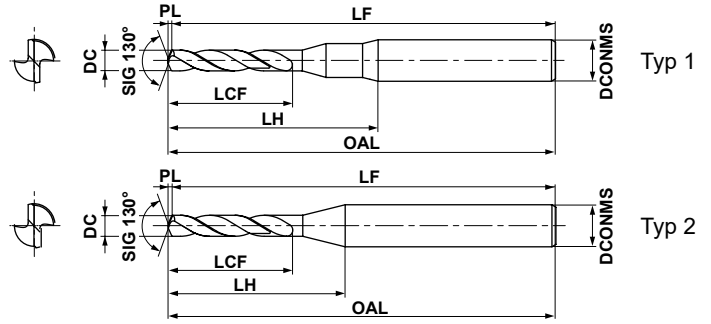

BOHREN

M

	$0.10 \leq DC \leq 0.99$
	$0$ $-0.009$
	DCONMS=3
	$0$ $-0.006$

● Die MSE-Bohrer eignen sich für die Verwendung mit Schrumpfaufnahmen.

DC (mm)	VP20MF	VP15TF	Bestellnummer	Abmessungen (mm)							Typ
				LCF	LH	OAL	LF	PL	DCONMS		
0.10	●		MSE0010SB	1.2	9.7	38.0	38	0.02	3	1	
0.11	●		MSE0011SB	1.2	9.7	38.0	38	0.03	3	1	
0.12	●		MSE0012SB	1.4	9.7	38.0	38	0.03	3	1	
0.13	●		MSE0013SB	1.4	9.7	38.0	38	0.03	3	1	
0.14	●		MSE0014SB	2.0	9.7	38.0	38	0.03	3	1	
0.15	●		MSE0015SB	2.0	9.7	38.0	38	0.03	3	1	
0.16	●		MSE0016SB	2.0	9.7	38.0	38	0.04	3	1	
0.17	●		MSE0017SB	2.0	9.7	38.0	38	0.04	3	1	
0.18	●		MSE0018SB	2.0	9.7	38.0	38	0.04	3	1	
0.19	●		MSE0019SB	2.0	9.7	38.0	38	0.04	3	1	
0.20	●		MSE0020SB	2.6	9.8	38.1	38	0.05	3	1	
0.21	●		MSE0021SB	2.6	9.8	38.1	38	0.05	3	1	
0.22	●		MSE0022SB	2.6	9.8	38.1	38	0.05	3	1	
0.23	●		MSE0023SB	2.6	9.8	38.1	38	0.05	3	1	
0.24	●		MSE0024SB	3.1	9.8	38.1	38	0.06	3	1	
0.25	●		MSE0025SB	3.1	9.8	38.1	38	0.06	3	1	
0.26	●		MSE0026SB	3.1	9.8	38.1	38	0.06	3	1	
0.27	●		MSE0027SB	3.1	9.8	38.1	38	0.06	3	1	
0.28	●		MSE0028SB	3.1	9.8	38.1	38	0.07	3	1	
0.29	●		MSE0029SB	3.1	9.8	38.1	38	0.07	3	1	
0.30	●		MSE0030SB	5.1	10.3	38.1	38	0.07	3	2	
0.31	●		MSE0031SB	5.1	10.3	38.1	38	0.07	3	2	
0.32	●		MSE0032SB	5.1	10.3	38.1	38	0.07	3	2	
0.33	●		MSE0033SB	5.1	10.3	38.1	38	0.08	3	2	
0.34	●		MSE0034SB	6.1	11.3	38.1	38	0.08	3	2	
0.35	●		MSE0035SB	6.1	11.2	38.1	38	0.08	3	2	
0.36	●		MSE0036SB	6.1	11.2	38.1	38	0.08	3	2	
0.37	●		MSE0037SB	6.1	11.2	38.1	38	0.09	3	2	
0.38	●		MSE0038SB	6.1	11.2	38.1	38	0.09	3	2	
0.39	●		MSE0039SB	6.1	11.2	38.1	38	0.09	3	2	
0.40	●		MSE0040SB	7.1	12.2	38.1	38	0.09	3	2	
0.41	●		MSE0041SB	7.1	12.1	38.1	38	0.10	3	2	
0.42	●		MSE0042SB	7.1	12.1	38.1	38	0.10	3	2	
0.43	●		MSE0043SB	7.1	12.1	38.1	38	0.10	3	2	
0.44	●		MSE0044SB	7.1	12.1	38.1	38	0.10	3	2	
0.45	●		MSE0045SB	7.1	12.1	38.1	38	0.10	3	2	
0.46	●		MSE0046SB	7.1	12.0	38.1	38	0.11	3	2	
0.47	●		MSE0047SB	7.1	12.0	38.1	38	0.11	3	2	
0.48	●		MSE0048SB	7.1	12.0	38.1	38	0.11	3	2	
0.49	●		MSE0049SB	7.1	12.0	38.1	38	0.11	3	2	
0.50	●		MSE0050SB	7.1	12.0	38.1	38	0.12	3	2	
0.51	●		MSE0051SB	7.1	11.9	38.1	38	0.12	3	2	
0.52	●		MSE0052SB	7.1	11.9	38.1	38	0.12	3	2	
0.53	●		MSE0053SB	7.1	11.9	38.1	38	0.12	3	2	
0.54	●		MSE0054SB	7.1	11.9	38.1	38	0.13	3	2	
0.55	●		MSE0055SB	7.1	11.9	38.1	38	0.13	3	2	
0.56	●		MSE0056SB	7.1	11.9	38.1	38	0.13	3	2	
0.57	●		MSE0057SB	7.1	11.8	38.1	38	0.13	3	2	
0.58	●		MSE0058SB	7.1	11.8	38.1	38	0.14	3	2	
0.59	●		MSE0059SB	7.1	11.8	38.1	38	0.14	3	2	
0.60	●		MSE0060SB	7.1	11.8	38.1	38	0.14	3	2	
0.61	●		MSE0061SB	7.1	11.8	38.1	38	0.14	3	2	
0.62	●		MSE0062SB	7.1	11.7	38.1	38	0.14	3	2	
0.63	●		MSE0063SB	7.2	11.8	38.2	38	0.15	3	2	
0.64	●		MSE0064SB	7.2	11.8	38.2	38	0.15	3	2	
0.65	●		MSE0065SB	7.2	11.8	38.2	38	0.15	3	2	
0.66	●		MSE0066SB	7.2	11.8	38.2	38	0.15	3	2	
0.67	●		MSE0067SB	7.2	11.7	38.2	38	0.16	3	2	
0.68	●		MSE0068SB	7.2	11.7	38.2	38	0.16	3	2	
0.69	●		MSE0069SB	7.2	11.7	38.2	38	0.16	3	2	
0.70	●		MSE0070SB	8.2	12.7	38.2	38	0.16	3	2	
0.71	●		MSE0071SB	8.2	12.7	38.2	38	0.17	3	2	
0.72	●		MSE0072SB	8.2	12.7	38.2	38	0.17	3	2	
0.73	●		MSE0073SB	8.2	12.6	38.2	38	0.17	3	2	
0.74	●		MSE0074SB	8.2	12.6	38.2	38	0.17	3	2	
0.75	●		MSE0075SB	8.2	12.6	38.2	38	0.17	3	2	
0.76	●		MSE0076SB	8.2	12.6	38.2	38	0.18	3	2	
0.77	●		MSE0077SB	8.2	12.6	38.2	38	0.18	3	2	

Hinweis 1) Bei Bedarf von abweichenden Geometrien setzen Sie sich mit uns in Verbindung.  
(Andere Durchmesser und Längen können bestellt werden).

● : Lagerstandard.

DC (mm)	VP20MF	VP15TF	Bestellnummer	Abmessungen (mm)						Typ
				LCF	LH	OAL	LF	PL	DCONMS	
0.78	●	●	MSE0078SB	8.2	12.5	38.2	38	0.18	3	2
0.79	●	●	MSE0079SB	8.2	12.5	38.2	38	0.18	3	2
0.80	●	●	MSE0080SB	10.2	14.5	38.2	38	0.19	3	2
0.81	●	●	MSE0081SB	10.2	14.5	38.2	38	0.19	3	2
0.82	●	●	MSE0082SB	10.2	14.5	38.2	38	0.19	3	2
0.83	●	●	MSE0083SB	10.2	14.5	38.2	38	0.19	3	2
0.84	●	●	MSE0084SB	10.2	14.4	38.2	38	0.20	3	2
0.85	●	●	MSE0085SB	10.2	14.4	38.2	38	0.20	3	2
0.86	●	●	MSE0086SB	10.2	14.4	38.2	38	0.20	3	2
0.87	●	●	MSE0087SB	10.2	14.4	38.2	38	0.20	3	2
0.88	●	●	MSE0088SB	10.2	14.4	38.2	38	0.21	3	2

DC (mm)	VP20MF	VP15TF	Bestellnummer	Abmessungen (mm)						Typ
				LCF	LH	OAL	LF	PL	DCONMS	
0.89	●	●	MSE0089SB	10.2	14.3	38.2	38	0.21	3	2
0.90	●	●	MSE0090SB	10.2	14.3	38.2	38	0.21	3	2
0.91	●	●	MSE0091SB	10.2	14.3	38.2	38	0.21	3	2
0.92	●	●	MSE0092SB	10.2	14.3	38.2	38	0.21	3	2
0.93	●	●	MSE0093SB	10.2	14.3	38.2	38	0.22	3	2
0.94	●	●	MSE0094SB	10.2	14.2	38.2	38	0.22	3	2
0.95	●	●	MSE0095SB	10.2	14.2	38.2	38	0.22	3	2
0.96	●	●	MSE0096SB	10.2	14.2	38.2	38	0.22	3	2
0.97	●	●	MSE0097SB	10.2	14.2	38.2	38	0.23	3	2
0.98	●	●	MSE0098SB	10.2	14.2	38.2	38	0.23	3	2
0.99	●	●	MSE0099SB	10.2	14.2	38.2	38	0.23	3	2

## SCHNITTDATENEMPFEHLUNGEN

Material	P										
	Allg. Baustahl ( $\leq 180\text{HB}$ )						C-Stahl, Leg. Stahl (180–280HB)				
	Ck10						Ck45, 41CrMo4				
Bohrer-Durchm. DC (mm)	Schnittgeschw. (m/min)	Drehzahl (min <sup>-1</sup> )	Vorschub (min.–max.) (mm/U.)	Bohrstufen (mm)	Tischvorschub (mm/min)	Schnittgeschw. (m/min)	Drehzahl (min <sup>-1</sup> )	Vorschub (min.–max.) (mm/U.)	Bohrstufen (mm)	Tischvorschub (mm/min)	
0.10	6	20000	0.002 (0.001–0.003)	0.02	40	6	20000	0.002 (0.001–0.003)	0.02	40	
0.12	8	20000	0.002 (0.001–0.003)	0.02	40	8	20000	0.002 (0.001–0.003)	0.02	40	
0.16	10	20000	0.002 (0.001–0.003)	0.02	40	10	20000	0.002 (0.001–0.003)	0.02	40	
0.20	13	20000	0.003 (0.002–0.004)	0.04	60	13	20000	0.003 (0.002–0.004)	0.04	60	
0.25	16	20000	0.003 (0.002–0.004)	0.04	60	16	20000	0.003 (0.002–0.004)	0.04	60	
0.32	20	20000	0.004 (0.003–0.005)	0.05	80	20	20000	0.004 (0.003–0.005)	0.05	80	
0.40	25	20000	0.004 (0.003–0.005)	0.05	80	25	20000	0.004 (0.003–0.005)	0.05	80	
0.50	31	20000	0.006 (0.005–0.007)	0.10	120	31	20000	0.006 (0.005–0.007)	0.10	120	
0.63	40	20000	0.008 (0.006–0.010)	0.10	160	40	20000	0.008 (0.006–0.010)	0.10	160	
0.80	50	20000	0.020 (0.015–0.025)	0.30	400	50	20000	0.015 (0.012–0.018)	0.30	300	
0.99	62	20000	0.040 (0.030–0.050)	0.30	800	62	20000	0.020 (0.015–0.025)	0.30	400	

Material	P										
	C-Stahl, Leg. Stahl (280–350HB)						Vergüteter Stahl (35–45HRC)				
	36CrNiMo4						X36CrMo17				
Bohrer-Durchm. DC (mm)	Schnittgeschw. (m/min)	Drehzahl (min <sup>-1</sup> )	Vorschub (min.–max.) (mm/U.)	Bohrstufen (mm)	Tischvorschub (mm/min)	Schnittgeschw. (m/min)	Drehzahl (min <sup>-1</sup> )	Vorschub (min.–max.) (mm/U.)	Bohrstufen (mm)	Tischvorschub (mm/min)	
0.10	6	20000	0.002 (0.001–0.003)	0.02	40	6	20000	0.002 (0.001–0.003)	0.02	40	
0.12	8	20000	0.002 (0.001–0.003)	0.02	40	8	20000	0.002 (0.001–0.003)	0.02	40	
0.16	10	20000	0.002 (0.001–0.003)	0.02	40	10	20000	0.002 (0.001–0.003)	0.02	40	
0.20	13	20000	0.003 (0.002–0.004)	0.04	60	13	20000	0.003 (0.002–0.004)	0.04	60	
0.25	16	20000	0.003 (0.002–0.004)	0.04	60	16	20000	0.003 (0.002–0.004)	0.04	60	
0.32	20	20000	0.004 (0.003–0.005)	0.05	80	20	20000	0.004 (0.003–0.005)	0.05	80	
0.40	25	20000	0.004 (0.003–0.005)	0.05	80	25	20000	0.004 (0.003–0.005)	0.05	80	
0.50	31	20000	0.006 (0.005–0.007)	0.10	120	31	20000	0.006 (0.005–0.007)	0.10	120	
0.63	40	20000	0.008 (0.006–0.010)	0.10	160	40	20000	0.008 (0.006–0.010)	0.10	160	
0.80	50	20000	0.015 (0.012–0.018)	0.30	300	50	20000	0.015 (0.012–0.018)	0.30	300	
0.99	62	20000	0.020 (0.015–0.025)	0.30	400	62	20000	0.020 (0.015–0.025)	0.30	400	

Hinweis 1) Der Einsatz des Zentrierbohrers ist empfohlen.

Hinweis 2) Die aufgeführten Schnittdaten können je nach Maschinenleistung,

Werkstückbeschaffenheit oder Spannung modifiziert werden, und gelten als allgemeine Empfehlung.

Hinweis 3) Bei Bohrtiefen > DCx5 werden die o.g. Bohrstufen zur Vorschubunterbrechung empfohlen.

Hinweis 4) Es wird Emulsion empfohlen. Bei Einsatz von Öl bitte Schnittwerte reduzieren.

Hinweis 5) Bei Werkstoffen der Gruppe "S" (-) ist der Einsatz von Bohrern ohne interne Kühlmittelzufuhr nicht empfohlen.

# BOHREN (VOLLHARTMETALL)

- Große Spannuten für optimale Spanabfuhr.
- Effiziente Bearbeitung kleinster Bohrungen.

# MSE

HARTMETALL

M

BOHREN

## SCHNITTDATENEMPFEHLUNGEN

Material	M					K				
	Rostfreier Stahl (austenitisch) (≤200HB) X5CrNi1810, X5CrNiMo17-12-2					Grauguss (≤350MPa) GG30				
Bohrer Durchm. DC (mm)	Schnittgeschw. (m/min)	Drehzahl (min <sup>-1</sup> )	Vorschub (min. – max.) (mm/U.)	Bohrstufen (mm)	Tischvorschub (mm/min)	Schnittgeschw. (m/min)	Drehzahl (min <sup>-1</sup> )	Vorschub (min. – max.) (mm/U.)	Bohrstufen (mm)	Tischvorschub (mm/min)
<b>0.10</b>	6	20000	0.002 (0.001–0.003)	0.02	40	6	20000	0.002 (0.001–0.003)	0.02	40
<b>0.12</b>	8	20000	0.002 (0.001–0.003)	0.02	40	8	20000	0.002 (0.001–0.003)	0.02	40
<b>0.16</b>	10	20000	0.002 (0.001–0.003)	0.02	40	10	20000	0.002 (0.001–0.003)	0.02	40
<b>0.20</b>	11	18000	0.003 (0.002–0.004)	0.04	54	13	20000	0.003 (0.002–0.004)	0.04	60
<b>0.25</b>	14	18000	0.003 (0.002–0.004)	0.04	54	16	20000	0.003 (0.002–0.004)	0.04	60
<b>0.32</b>	15	15000	0.004 (0.003–0.005)	0.05	60	20	20000	0.004 (0.003–0.005)	0.05	80
<b>0.40</b>	19	15000	0.004 (0.003–0.005)	0.05	60	25	20000	0.004 (0.003–0.005)	0.05	80
<b>0.50</b>	16	10000	0.006 (0.005–0.007)	0.10	60	31	20000	0.006 (0.005–0.007)	0.10	120
<b>0.63</b>	20	10000	0.008 (0.006–0.010)	0.10	80	40	20000	0.008 (0.006–0.010)	0.10	160
<b>0.80</b>	15	6000	0.015 (0.012–0.018)	0.20	90	50	20000	0.020 (0.015–0.025)	0.30	400
<b>0.99</b>	19	6000	0.020 (0.015–0.025)	0.20	120	62	20000	0.040 (0.030–0.050)	0.30	800

Material	N					S				
	Aluminiumleg. (Si<5%)					Hitzebeständiger Stahl Inconel®718				
Bohrer Durchm. DC (mm)	Schnittgeschw. (m/min)	Drehzahl (min <sup>-1</sup> )	Vorschub (min. – max.) (mm/U.)	Bohrstufen (mm)	Tischvorschub (mm/min)	Schnittgeschw. (m/min)	Drehzahl (min <sup>-1</sup> )	Vorschub (min. – max.) (mm/U.)	Bohrstufen (mm)	Tischvorschub (mm/min)
<b>0.10</b>	6	20000	0.002 (0.001–0.003)	0.05	40	2	7000	0.001 (0.0005–0.001)	0.02	7
<b>0.12</b>	8	20000	0.003 (0.002–0.004)	0.05	60	3	7000	0.001 (0.0005–0.001)	0.02	7
<b>0.16</b>	10	20000	0.004 (0.003–0.005)	0.05	80	4	7000	0.001 (0.0005–0.001)	0.02	7
<b>0.20</b>	13	20000	0.006 (0.005–0.007)	0.10	120	3	5000	0.002 (0.001–0.002)	0.04	10
<b>0.25</b>	16	20000	0.008 (0.006–0.010)	0.10	160	4	5000	0.002 (0.001–0.002)	0.04	10
<b>0.32</b>	20	20000	0.010 (0.008–0.012)	0.30	200	4	4000	0.002 (0.001–0.002)	0.05	8
<b>0.40</b>	25	20000	0.020 (0.015–0.025)	0.30	400	5	4000	0.002 (0.001–0.002)	0.05	8
<b>0.50</b>	31	20000	0.030 (0.025–0.035)	0.50	600	5	3000	0.003 (0.001–0.003)	0.10	9
<b>0.63</b>	40	20000	0.040 (0.035–0.045)	0.50	800	6	3000	0.004 (0.002–0.004)	0.10	12
<b>0.80</b>	50	20000	0.050 (0.045–0.055)	0.80	1000	5	1800	0.006 (0.004–0.006)	0.20	10.8
<b>0.99</b>	62	20000	0.060 (0.055–0.065)	0.80	1200	6	1800	0.010 (0.008–0.010)	0.20	18

Hinweis 1) Der Einsatz des Zentrierbohrers ist empfohlen.

Hinweis 2) Die aufgeführten Schnittdaten können je nach Maschinenleistung,

Werkstückbeschaffenheit oder Spannung modifiziert werden, und gelten als allgemeine Empfehlung.

Hinweis 3) Bei Bohrtiefen > DCx5 werden die o.g. Bohrstufen zur Vorschubunterbrechung empfohlen.

Hinweis 4) Es wird Emulsion empfohlen. Bei Einsatz von Öl bitte Schnittwerte reduzieren.

Hinweis 5) Bei Werkstoffen der Gruppe "S" (-) ist der Einsatz von Bohrern ohne interne Kühlmittelzufuhr nicht empfohlen.



# MSP

Pilotbohrer für MSE



HARTMETALL

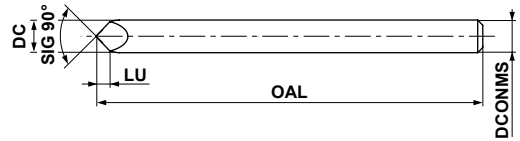

M

BOHREN

Bestellnummer	Sorte	Lager	Abmessungen (mm)				Durchmesserbereich (mm)
			DC	LU	OAL	DCONMS	
MSP0300SB	VP15TF	●	3.0	1.5	38.0	3.0	0.1–3.0

## SCHNITTDATENEMPFEHLUNGEN

Bohrdurchmesser (mm)	Drehzahl (min <sup>-1</sup> )	Vorschub (min.–max.) (mm/U.)	Tischvorschub (mm/min)
0.1–3.0	10000	0.0005 (0.00025–0.001)	5

● : Lagerstandard.

# BOHREN (VOLLHARTMETALL)

## DLE

Multifunktionsanbohrer



Externe Kühlung

■ Spitzenwinkel SIG 60°, 90°

BOHREN

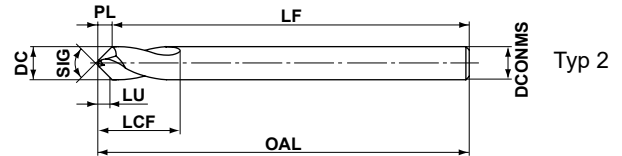
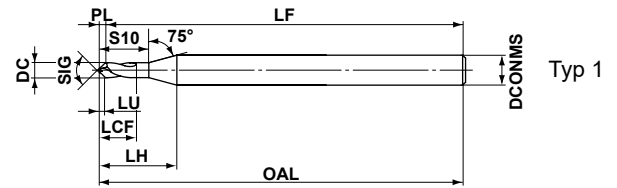

■ Spitzenwinkel SIG 120°, 145°

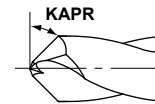

DCONMS=3	3 < DCONMS ≤ 6	6 < DCONMS ≤ 10	10 < DCONMS ≤ 16
$\begin{matrix} 0 \\ -0.010 \end{matrix}$	$\begin{matrix} 0 \\ -0.012 \end{matrix}$	$\begin{matrix} 0 \\ -0.015 \end{matrix}$	$\begin{matrix} 0 \\ -0.018 \end{matrix}$

DC (mm)	SIG	DP1020	DP102A	Bestellnummer	Abmessungen (mm)								Typ	
					LU	LCF	LH	S10	OAL	LF	PL	KAPR		DCONMS
3.0	60°	●		DLE0300S030P060	2.0	9	—	—	45	42.9	2.1	60°	3	2
4.0	60°	●		DLE0400S040P060	2.7	12	—	—	50	47.2	2.8	60°	4	2
5.0	60°	●		DLE0500S050P060	3.4	14	—	—	60	56.5	3.5	60°	5	2
6.0	60°	●		DLE0600S060P060	4.0	15	—	—	66	61.8	4.2	60°	6	2
7.0	60°	●		DLE0700S070P060	4.7	18	—	—	74	69.1	4.9	60°	7	2
8.0	60°	●		DLE0800S080P060	5.4	20	—	—	74	68.4	5.6	60°	8	2
10.0	60°	●		DLE1000S100P060	6.8	24	—	—	84	77.0	7.0	60°	10	2
12.0	60°	●		DLE1200S120P060	8.1	28	—	—	95	86.6	8.4	60°	12	2
1.0	90°	●		DLE0100S030P090	0.35	2	6.7	3.0	45	44.6	0.4	45°	3	1
1.5	90°	●		DLE0150S030P090	0.55	3	7.3	4.5	45	44.4	0.6	45°	3	1
2.0	90°	●		DLE0200S030P090	0.8	4	7.9	6.1	45	44.1	0.9	45°	3	1
2.5	90°	●		DLE0250S030P090	1.0	5	7.9	7.1	45	43.9	1.1	45°	3	1
3.0	90°	●		DLE0300S030P090	1.2	9	—	—	45	43.7	1.3	45°	3	2
4.0	90°	●		DLE0400S040P090	1.6	12	—	—	50	48.3	1.7	45°	4	2
5.0	90°	●		DLE0500S050P090	2.0	14	—	—	60	57.9	2.1	45°	5	2
6.0	90°	●		DLE0600S060P090	2.4	15	—	—	66	63.4	2.6	45°	6	2
7.0	90°	●		DLE0700S070P090	2.8	18	—	—	74	71.0	3.0	45°	7	2
8.0	90°	●		DLE0800S080P090	3.2	20	—	—	74	70.6	3.4	45°	8	2
10.0	90°	●		DLE1000S100P090	4.1	24	—	—	84	79.7	4.3	45°	10	2
12.0	90°	●		DLE1200S120P090	4.9	28	—	—	95	89.9	5.1	45°	12	2
16.0	90°	●		DLE1600S160P090	6.6	35	—	—	113	106.2	6.8	45°	16	2

Hinweis 1) Im Bereich von etwa DC/4, dem Bereich der zweistufigen Spitzenwinkel, weist der zentrale Bereich keinen 60°- und 90°-Bohrungsgrund auf. Das Anfasen ist in diesem Bereich ebenfalls nicht möglich.

Hinweis 2) Der Zentrierdurchmesser sollte kleiner als der Bohrerdurchmesser (Verarbeitungsdurchmesser) DC sein, und die nutzbare Länge LU sollte als Richtwert herangezogen werden.

● : Lagerstandard.

DC (mm)	SIG	DP1020	DP102A	Bestellnummer	Abmessungen (mm)								Typ	
					LU	LCF	LH	S10	OAL	LF	PL	KAPR		DCONMS
3.0	120°	●		<b>DLE0300S030P120</b>	0.8	9	—	—	45	44.1	0.9	30°	3	2
4.0	120°	●		<b>DLE0400S040P120</b>	1.1	12	—	—	50	48.8	1.2	30°	4	2
5.0	120°	●		<b>DLE0500S050P120</b>	1.3	14	—	—	60	58.6	1.4	30°	5	2
6.0	120°	●		<b>DLE0600S060P120</b>	1.6	15	—	—	66	64.3	1.7	30°	6	2
7.0	120°	●		<b>DLE0700S070P120</b>	1.9	18	—	—	74	72.0	2.0	30°	7	2
8.0	120°	●		<b>DLE0800S080P120</b>	2.2	20	—	—	74	71.7	2.3	30°	8	2
10.0	120°	●		<b>DLE1000S100P120</b>	2.8	24	—	—	84	81.1	2.9	30°	10	2
12.0	120°	●		<b>DLE1200S120P120</b>	3.3	28	—	—	95	91.5	3.5	30°	12	2
3.0	145°	●		<b>DLE0300S030P145</b>	0.4	9	—	—	45	44.5	0.5	17.5°	3	2
4.0	145°	●		<b>DLE0400S040P145</b>	0.5	12	—	—	50	49.4	0.6	17.5°	4	2
5.0	145°	●		<b>DLE0500S050P145</b>	0.7	14	—	—	60	59.2	0.8	17.5°	5	2
6.0	145°	●		<b>DLE0600S060P145</b>	0.8	15	—	—	66	65.1	0.9	17.5°	6	2
7.0	145°	●		<b>DLE0700S070P145</b>	1.0	18	—	—	74	72.9	1.1	17.5°	7	2
8.0	145°	●		<b>DLE0800S080P145</b>	1.1	20	—	—	74	72.7	1.3	17.5°	8	2
10.0	145°	●		<b>DLE1000S100P145</b>	1.4	24	—	—	84	82.4	1.6	17.5°	10	2
12.0	145°	●		<b>DLE1200S120P145</b>	1.7	28	—	—	95	93.1	1.9	17.5°	12	2

Hinweis 1) Der Zentrierdurchmesser sollte kleiner als der Bohrerdurchmesser (Verarbeitungsdurchmesser) **DC** sein, und die nutzbare Länge **LU** sollte als Richtwert herangezogen werden.

M

BOHREN

## AUSWAHL DES BOHRERDURCHMESSERS

### BEIM ANFASEN

Bezogen auf den Bohrdurchmesser **D** wählen Sie den Bohrerdurchmesser (Schnittdurchmesser) **DC** im Bereich von  $D < DC < 2D$ .

**OK**

**X**

**X**

**DC**

**D**

**Wenn DC gleich oder größer als 2D ist:**

Ist der Bohrerdurchmesser **DC** im Vergleich zum Bohrdurchmesser **D** (gleich oder größer als **2D**) zu groß, ist kein Anfasen möglich.

**Wenn der Bohrerdurchmesser DC gleich D ist:**

Ein Anfasen ist nicht möglich, wenn der Bohrerdurchmesser **DC** gleich dem Bohrlochdurchmesser **D** ist.

Wenn der Bohrdurchmesser **D** 5 mm beträgt: Der Bohrerdurchmesser **DC** sollte gleich oder größer als 6 mm, aber kleiner als 10 mm sein. Wählen Sie einen **DC** von 6 mm, 7 mm oder 8 mm.

### BEIM ZENTRIEREN

Der Zentrierdurchmesser sollte kleiner als der Bohrerdurchmesser (Bohrungsdurchmesser) **DC** sein, und die nutzbare Länge sollte als Richtwert herangezogen werden.

Der zentrale Bereich von Bohrungen (etwa 25 % des Bohrdurchmessers), der aus zweistufigen Spitzenwinkeln besteht, wird nicht die entsprechenden Winkel von 60° und 90° haben. Anfasen ist in diesen zentralen Bereichen ebenfalls nicht möglich.

Wählen Sie einen Zentrierbohrer mit einem größeren Spitzenwinkel als der Folgebohrer, wenn zunächst Kontakt im Zentrum hergestellt werden soll.

Folgebohrer

**DC**

**DC/4**

**DC**

**LU**

**PL**

Anzentrieren mit SIG145° Spitzenwinkel

## Tabelle der Bohrtiefen (L) nach Werkzeugdurchmesser

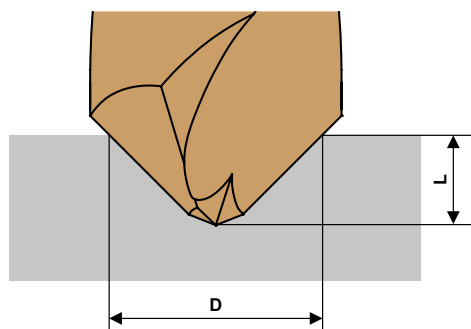

(mm)

DC	SIG 90°			
	Min.		Max.	
	D	L	D	L
1.0	0.5	0.18	0.8	0.33
1.5	0.8	0.29	1.3	0.54
2.0	1.0	0.35	1.9	0.8
2.5	1.3	0.47	2.4	1.0
3.0	1.5	0.5	2.8	1.2
4.0	2.0	0.7	3.8	1.6
5.0	2.5	0.9	4.7	2.0
6.0	3.0	1.1	5.7	2.4
7.0	3.5	1.2	6.6	2.8
8.0	4.0	1.4	7.6	3.2
10.0	5.0	1.8	9.7	4.1
12.0	6.0	2.1	11.6	4.9
16.0	8.0	2.8	15.5	6.6

M

BOHREN

(mm)

DC	SIG 60°				SIG 120°				SIG 145°			
	Min.		Max.		Min.		Max.		Min.		Max.	
	D	L	D	L	D	L	D	L	D	L	D	L
3.0	1.5	0.8	2.9	2.0	1.5	0.4	2.8	0.8	1.5	0.2	2.5	0.4
4.0	2.0	1.1	3.9	2.7	2.0	0.6	3.8	1.1	2.0	0.3	3.2	0.5
5.0	2.5	1.3	4.9	3.4	2.5	0.7	4.5	1.3	2.5	0.4	4.4	0.7
6.0	3.0	1.6	5.8	4.0	3.0	0.9	5.5	1.6	3.0	0.5	5.1	0.8
7.0	3.5	1.9	6.8	4.7	3.5	1.0	6.6	1.9	3.5	0.6	6.3	1.0
8.0	4.0	2.1	7.8	5.4	4.0	1.2	7.6	2.2	4.0	0.6	7.0	1.1
10.0	5.0	2.7	9.8	6.8	5.0	1.4	9.7	2.8	5.0	0.8	8.9	1.4
12.0	6.0	3.2	11.6	8.1	6.0	1.7	11.4	3.3	6.0	0.9	10.8	1.7

# BOHREN (VOLLHARTMETALL)

## DLE

Multifunktionsanbohrer

### Spitzenwinkel SIG 60°

### SCHNITTDATENEMPFEHLUNGEN

BOHREN

Material	P					
	Allg. Baustahl ( $\leq 180\text{HB}$ )		C-Stahl, Leg. Stahl ( $180-280\text{HB}$ )		C-Stahl, Leg. Stahl ( $280-350\text{HB}$ )	
	C10E usw.		Ck45, 41CrMo4 usw.		40CrNiMoA usw.	
Bohrer-Durchm. DC (mm)	Drehzahl (min <sup>-1</sup> )	Vorschub (min.-max.) (mm/U.)	Drehzahl (min <sup>-1</sup> )	Vorschub (min.-max.) (mm/U.)	Drehzahl (min <sup>-1</sup> )	Vorschub (min.-max.) (mm/U.)
<b>3.0</b>	7900	0.05 (0.03–0.07)	6800	0.05 (0.03–0.07)	6300	0.04 (0.02–0.06)
<b>4.0</b>	5900	0.05 (0.03–0.07)	5100	0.05 (0.03–0.07)	4700	0.04 (0.02–0.06)
<b>5.0</b>	5000	0.06 (0.04–0.08)	4400	0.06 (0.04–0.08)	4100	0.05 (0.03–0.07)
<b>6.0</b>	4200	0.06 (0.04–0.08)	3700	0.06 (0.04–0.08)	3400	0.05 (0.03–0.07)
<b>7.0</b>	3600	0.07 (0.04–0.09)	3100	0.07 (0.04–0.09)	2900	0.05 (0.03–0.07)
<b>8.0</b>	3100	0.07 (0.04–0.09)	2700	0.07 (0.04–0.09)	2500	0.05 (0.03–0.07)
<b>10.0</b>	2700	0.08 (0.04–0.10)	2300	0.08 (0.04–0.10)	2200	0.06 (0.03–0.08)
<b>12.0</b>	2200	0.08 (0.04–0.10)	1900	0.08 (0.04–0.10)	1800	0.06 (0.03–0.08)

Material	M		K			
	Rostfreier Stahl (austenitisch) ( $\leq 200\text{HB}$ )		Grauguss ( $\leq 350\text{MPa}$ )		Duktiler Guss ( $\leq 450\text{MPa}$ )	
	X5CrNi189, X5CrNiMo1810 usw.		GG30 usw.		GGG40.3 usw.	
Bohrer-Durchm. DC (mm)	Drehzahl (min <sup>-1</sup> )	Vorschub (min.-max.) (mm/U.)	Drehzahl (min <sup>-1</sup> )	Vorschub (min.-max.) (mm/U.)	Drehzahl (min <sup>-1</sup> )	Vorschub (min.-max.) (mm/U.)
<b>3.0</b>	1500	0.03 (0.01–0.05)	7900	0.05 (0.03–0.07)	5800	0.05 (0.03–0.07)
<b>4.0</b>	1100	0.03 (0.01–0.05)	5900	0.05 (0.03–0.07)	4300	0.05 (0.03–0.07)
<b>5.0</b>	1200	0.04 (0.02–0.06)	5000	0.06 (0.04–0.08)	3800	0.06 (0.04–0.08)
<b>6.0</b>	1000	0.04 (0.02–0.06)	4200	0.06 (0.04–0.08)	3100	0.06 (0.04–0.08)
<b>7.0</b>	900	0.04 (0.02–0.06)	3600	0.07 (0.04–0.09)	2700	0.06 (0.04–0.08)
<b>8.0</b>	790	0.04 (0.02–0.06)	3100	0.07 (0.04–0.09)	2300	0.06 (0.04–0.08)
<b>10.0</b>	630	0.04 (0.02–0.06)	2700	0.08 (0.04–0.10)	1900	0.07 (0.04–0.09)
<b>12.0</b>	530	0.04 (0.02–0.06)	2200	0.08 (0.04–0.10)	1500	0.07 (0.04–0.09)

Hinweis 1) Verwenden Sie einen Bohrer, der größer (DC) ist als der Fertigdurchmesser, aber kleiner als 2 x DC.

Hinweis 2) Beim Zentrierbohren auf gewölbten und schrägen Flächen reduzieren Sie bitte den Vorschub.

Hinweis 3) Beim Bearbeiten von V-Nuten und Kantenfasen sind die Schnittdaten entsprechend zu verringern.

Hinweis 4) Wenn Vibrationen oder ungewöhnliche Geräusche auftreten, verkürzen Sie die Verweilzeit oder reduzieren Sie die Drehzahl.

Hinweis 5) Achten Sie beim Zentrierbohren darauf, die LU (Nutzlänge) nicht zu überschreiten.

### EINSATZHINWEISE

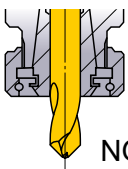
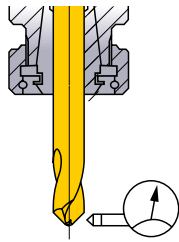
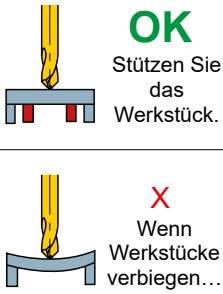
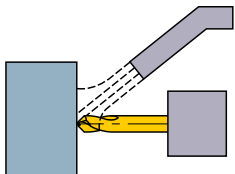
<p><b>Bohrer Aufnahme</b></p>  <p>Präzisionsspannzangen können verwendet werden.</p>	<p><b>Max. Bohrtiefe</b></p>  <p>Nicht auf den Nuten spannen.</p>	<p><b>Rundlauftoleranz</b></p>  <p>Rundlaufabweichung <math>\leq 0.03\text{mm}</math></p>	<p><b>Dünne Werkstücke</b></p>  <p><b>OK</b> Stützen Sie das Werkstück.</p> <p><b>X</b> Wenn Werkstücke verbiegen...</p>	<p><b>Kühlmittelezufuhr</b></p>  <p>Zwei Kühlmittleitungen sind ideal. (Bohrerspitze und Bohrermitte)</p>
---	--	--	--	--

# Spitzenwinkel SIG 90°, 120° und 145°

## SCHNITTDATENEMPFEHLUNGEN

Material	P					
	Allg. Baustahl ( $\leq 180\text{HB}$ )		C-Stahl, Leg. Stahl (180–280HB)		C-Stahl, Leg. Stahl (280–350HB)	
	C10E usw.		Ck45, 41CrMo4 usw.		40CrNiMoA usw.	
Bohrer Durchm. DC (mm)	Drehzahl (min <sup>-1</sup> )	Vorschub (min.–max.) (mm/U.)	Drehzahl (min <sup>-1</sup> )	Vorschub (min.–max.) (mm/U.)	Drehzahl (min <sup>-1</sup> )	Vorschub (min.–max.) (mm/U.)
<b>1.0</b>	9500	0.02 (0.01–0.03)	6300	0.02 (0.01–0.03)	4700	0.02 (0.01–0.03)
<b>1.5</b>	9500	0.02 (0.01–0.03)	7400	0.02 (0.01–0.03)	6300	0.02 (0.01–0.03)
<b>2.0</b>	9500	0.04 (0.03–0.05)	7900	0.04 (0.03–0.05)	7100	0.04 (0.03–0.05)
<b>2.5</b>	9500	0.04 (0.03–0.05)	8200	0.04 (0.03–0.05)	7600	0.04 (0.03–0.05)
<b>3.0</b>	7900	0.06 (0.04–0.08)	6800	0.06 (0.04–0.08)	6300	0.05 (0.03–0.07)
<b>4.0</b>	5900	0.06 (0.04–0.08)	5100	0.06 (0.04–0.08)	4700	0.05 (0.03–0.07)
<b>5.0</b>	5000	0.07 (0.05–0.09)	4400	0.07 (0.05–0.09)	4100	0.06 (0.04–0.08)
<b>6.0</b>	4200	0.07 (0.05–0.09)	3700	0.07 (0.05–0.09)	3400	0.06 (0.04–0.08)
<b>7.0</b>	3600	0.08 (0.05–0.10)	3100	0.08 (0.05–0.10)	2900	0.06 (0.04–0.08)
<b>8.0</b>	3100	0.08 (0.05–0.10)	2700	0.08 (0.05–0.10)	2500	0.06 (0.04–0.08)
<b>10.0</b>	2700	0.09 (0.05–0.11)	2300	0.09 (0.05–0.11)	2200	0.07 (0.04–0.09)
<b>12.0</b>	2200	0.09 (0.05–0.11)	1900	0.09 (0.05–0.11)	1800	0.07 (0.04–0.09)
<b>16.0</b>	1700	0.12 (0.10–0.14)	1500	0.12 (0.10–0.14)	1400	0.08 (0.06–0.10)

Material	M		K			
	Rostfreier Stahl (austenitisch) ( $\leq 200\text{HB}$ )		Grauguss ( $\leq 350\text{MPa}$ )		Duktiler Guss ( $\leq 450\text{MPa}$ )	
	X5CrNi189, X5CrNiMo1810 usw.		GG30 usw.		GGG40.3 usw.	
Bohrer Durchm. DC (mm)	Drehzahl (min <sup>-1</sup> )	Vorschub (min.–max.) (mm/U.)	Drehzahl (min <sup>-1</sup> )	Vorschub (min.–max.) (mm/U.)	Drehzahl (min <sup>-1</sup> )	Vorschub (min.–max.) (mm/U.)
<b>1.0</b>	6300	0.01 (0.005–0.015)	9500	0.02 (0.01–0.03)	3100	0.02 (0.01–0.03)
<b>1.5</b>	4200	0.01 (0.005–0.015)	9500	0.02 (0.01–0.03)	5300	0.02 (0.01–0.03)
<b>2.0</b>	3100	0.04 (0.03–0.05)	9500	0.04 (0.03–0.05)	6300	0.04 (0.03–0.05)
<b>2.5</b>	2500	0.04 (0.03–0.05)	9500	0.04 (0.03–0.05)	7000	0.04 (0.03–0.05)
<b>3.0</b>	2100	0.04 (0.02–0.06)	7900	0.06 (0.04–0.08)	5800	0.06 (0.04–0.08)
<b>4.0</b>	1600	0.04 (0.02–0.06)	5900	0.06 (0.04–0.08)	4300	0.06 (0.04–0.08)
<b>5.0</b>	1200	0.06 (0.04–0.08)	5000	0.07 (0.05–0.09)	3800	0.07 (0.05–0.09)
<b>6.0</b>	1000	0.06 (0.04–0.08)	4200	0.07 (0.05–0.09)	3100	0.07 (0.05–0.09)
<b>7.0</b>	900	0.06 (0.04–0.08)	3600	0.08 (0.05–0.10)	2700	0.07 (0.05–0.09)
<b>8.0</b>	790	0.06 (0.04–0.08)	3100	0.08 (0.05–0.10)	2300	0.07 (0.05–0.09)
<b>10.0</b>	630	0.06 (0.04–0.08)	2700	0.09 (0.05–0.11)	1900	0.08 (0.05–0.10)
<b>12.0</b>	530	0.06 (0.04–0.08)	2200	0.09 (0.05–0.11)	1500	0.08 (0.05–0.10)
<b>16.0</b>	390	0.08 (0.06–0.10)	1700	0.12 (0.10–0.14)	1100	0.11 (0.09–0.13)

Hinweis 1) Verwenden Sie einen Bohrer, der größer (DC) ist als der Fertigdurchmesser, aber kleiner ist als 2 x DC.

Hinweis 2) Beim Zentrierbohren auf gewölbten und schrägen Flächen reduzieren Sie bitte den Vorschub.

Hinweis 3) Beim Bearbeiten von V-Nuten und Kantenfasen sind die Schnittdaten entsprechend zu verringern.

Hinweis 4) Wenn Vibrationen oder ungewöhnliche Geräusche auftreten, verkürzen Sie die Verweilzeit oder reduzieren Sie die Drehzahl.

Hinweis 5) Achten Sie beim Zentrierbohren darauf, die LU (Nutzlänge) nicht zu überschreiten.

M

BOHREN

# BOHREN (VOLLHARTMETALL)

## MINI-MFE für kleine Durchmesser



Externe Kühlung

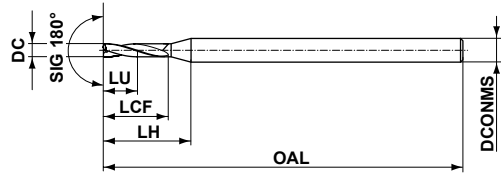

Typ 1

BOHREN

$0.75 \leq DC \leq 2.95$	
$0$ $-0.014$	
DCONMS=3	DCONMS=4
$0$ $-0.006$	$0$ $-0.008$

DC (mm)	Bohr- tiefe (L/D)	DP102A	Bestellnummer	Abmessungen (mm)					Typ
				LU	LCF	LH	OAL	DCONMS	
0.75	2	★	MFE0075X02S030	1.5	3.0	7.7	45	3	1
0.80	2	★	MFE0080X02S030	1.6	3.2	7.8	45	3	1
0.85	2	★	MFE0085X02S030	1.7	3.4	7.9	45	3	1
0.90	2	★	MFE0090X02S030	1.8	3.6	8.0	45	3	1
0.95	2	★	MFE0095X02S030	1.9	3.8	8.1	45	3	1
1.00	2	★	MFE0100X02S030	2.0	4.0	8.2	45	3	1
1.05	2	★	MFE0105X02S030	2.1	4.2	8.3	45	3	1
1.10	2	★	MFE0110X02S030	2.2	4.4	8.4	45	3	1
1.15	2	★	MFE0115X02S030	2.3	4.6	8.6	45	3	1
1.20	2	★	MFE0120X02S030	2.4	4.8	8.7	45	3	1
1.25	2	★	MFE0125X02S030	2.5	5.0	8.8	45	3	1
1.30	2	★	MFE0130X02S030	2.6	5.2	8.9	45	3	1
1.35	2	★	MFE0135X02S030	2.7	5.4	9.0	45	3	1
1.40	2	★	MFE0140X02S030	2.8	5.6	9.1	45	3	1
1.45	2	★	MFE0145X02S030	2.9	5.8	9.2	45	3	1
1.50	2	★	MFE0150X02S030	3.0	6.0	9.3	45	3	1
1.55	2	★	MFE0155X02S030	3.1	6.2	9.4	45	3	1
1.60	2	★	MFE0160X02S030	3.2	6.4	9.5	45	3	1
1.65	2	★	MFE0165X02S030	3.3	6.6	9.6	45	3	1
1.70	2	★	MFE0170X02S030	3.4	6.8	9.7	45	3	1
1.75	2	★	MFE0175X02S030	3.5	7.0	9.8	45	3	1
1.80	2	★	MFE0180X02S030	3.6	7.2	9.9	45	3	1
1.85	2	★	MFE0185X02S030	3.7	7.4	10.0	45	3	1
1.90	2	★	MFE0190X02S030	3.8	7.6	10.2	45	3	1
1.95	2	★	MFE0195X02S030	3.9	7.8	10.3	45	3	1
2.00	2	★	MFE0200X02S040	4.0	8.0	12.2	50	4	1
2.05	2	★	MFE0205X02S040	4.1	8.2	12.3	50	4	1
2.10	2	★	MFE0210X02S040	4.2	8.4	12.4	50	4	1
2.15	2	★	MFE0215X02S040	4.3	8.6	12.6	50	4	1
2.20	2	★	MFE0220X02S040	4.4	8.8	12.7	50	4	1
2.25	2	★	MFE0225X02S040	4.5	9.0	12.8	50	4	1
2.30	2	★	MFE0230X02S040	4.6	9.2	12.9	50	4	1
2.35	2	★	MFE0235X02S040	4.7	9.4	13.0	50	4	1
2.40	2	★	MFE0240X02S040	4.8	9.6	13.1	50	4	1
2.45	2	★	MFE0245X02S040	4.9	9.8	13.2	50	4	1
2.50	2	★	MFE0250X02S040	5.0	10.0	13.3	50	4	1
2.55	2	★	MFE0255X02S040	5.1	10.2	13.4	50	4	1
2.60	2	★	MFE0260X02S040	5.2	10.4	13.5	50	4	1
2.65	2	★	MFE0265X02S040	5.3	10.6	13.6	50	4	1
2.70	2	★	MFE0270X02S040	5.4	10.8	13.7	50	4	1
2.75	2	★	MFE0275X02S040	5.5	11.0	13.8	50	4	1
2.80	2	★	MFE0280X02S040	5.6	11.2	13.9	50	4	1
2.85	2	★	MFE0285X02S040	5.7	11.4	14.0	50	4	1
2.90	2	★	MFE0290X02S040	5.8	11.6	14.2	50	4	1
2.95	2	★	MFE0295X02S040	5.9	11.8	14.3	50	4	1

★ : Lagerstandard in Japan.



## SCHNITTDATENEMPFEHLUNGEN

Material		P					
		Allg. Baustahl ( $\leq 180\text{HB}$ ) C10E usw.		C-Stahl, Leg. Stahl (180–280HB) Ck45, 41CrMo4 usw.		C-Stahl, Leg. Stahl (280–350HB) 40CrNiMoA usw.	
Bohrer Durchm. DC (mm)	L/D	Drehzahl ( $\text{min}^{-1}$ )	$\alpha=0^\circ$ Vorschub (min.–max.) (mm/U.)	Drehzahl ( $\text{min}^{-1}$ )	$\alpha=0^\circ$ Vorschub (min.–max.) (mm/U.)	Drehzahl ( $\text{min}^{-1}$ )	$\alpha=0^\circ$ Vorschub (min.–max.) (mm/U.)
<b>0.75</b>	$\leq 2$	23300	0.030 (0.010–0.050)	19000	0.030 (0.010–0.050)	16900	0.030 (0.010–0.050)
<b>1.0</b>	$\leq 2$	17500	0.030 (0.010–0.050)	14300	0.030 (0.010–0.050)	12700	0.030 (0.010–0.050)
<b>1.5</b>	$\leq 2$	12200	0.035 (0.015–0.055)	10000	0.035 (0.015–0.055)	8400	0.035 (0.015–0.050)
<b>2.0</b>	$\leq 2$	9500	0.040 (0.020–0.060)	7900	0.040 (0.020–0.060)	6700	0.040 (0.020–0.060)
<b>2.5</b>	$\leq 2$	7900	0.050 (0.030–0.070)	6600	0.050 (0.030–0.070)	5700	0.050 (0.030–0.070)
<b>2.95</b>	$\leq 2$	7900	0.060 (0.040–0.080)	7900	0.060 (0.040–0.080)	6800	0.060 (0.040–0.080)

Material		M		K			
		Rostfreier Stahl (austenitisch) ( $\leq 200\text{HB}$ ) X5CrNi189, X5CrNiMo1810 usw.		Grauguss ( $\leq 350\text{MPa}$ ) GG30 usw.		Duktiler Guss ( $\leq 450\text{MPa}$ ) GGG40.3 usw.	
Bohrer Durchm. DC (mm)	L/D	Drehzahl ( $\text{min}^{-1}$ )	$\alpha=0^\circ$ Vorschub (min.–max.) (mm/U.)	Drehzahl ( $\text{min}^{-1}$ )	$\alpha=0^\circ$ Vorschub (min.–max.) (mm/U.)	Drehzahl ( $\text{min}^{-1}$ )	$\alpha=0^\circ$ Vorschub (min.–max.) (mm/U.)
<b>0.75</b>	$\leq 2$	10600	0.007 (0.003–0.011)	23300	0.030 (0.010–0.050)	16900	0.010 (0.005–0.015)
<b>1.0</b>	$\leq 2$	7900	0.007 (0.003–0.011)	17500	0.030 (0.010–0.050)	12700	0.010 (0.005–0.015)
<b>1.5</b>	$\leq 2$	5300	0.010 (0.005–0.015)	12200	0.035 (0.015–0.055)	10000	0.020 (0.010–0.030)
<b>2.0</b>	$\leq 2$	4700	0.015 (0.010–0.020)	9500	0.040 (0.020–0.060)	8700	0.030 (0.015–0.045)
<b>2.5</b>	$\leq 2$	3800	0.015 (0.010–0.020)	7900	0.050 (0.030–0.070)	7300	0.045 (0.025–0.065)
<b>2.95</b>	$\leq 2$	3100	0.020 (0.010–0.030)	7900	0.060 (0.040–0.080)	6800	0.050 (0.040–0.060)

Material		N	
		Aluminiumleg. (Si<5%) AlMg1SiCu, AlZn5MgCu usw.	
Bohrer Durchm. DC (mm)	L/D	Drehzahl ( $\text{min}^{-1}$ )	$\alpha=0^\circ$ Vorschub (min.–max.) (mm/U.)
<b>0.75</b>	$\leq 2$	42400	0.020 (0.010–0.030)
<b>1.0</b>	$\leq 2$	31800	0.020 (0.010–0.030)
<b>1.5</b>	$\leq 2$	21200	0.020 (0.010–0.030)
<b>2.0</b>	$\leq 2$	17500	0.050 (0.030–0.070)
<b>2.5</b>	$\leq 2$	14000	0.060 (0.040–0.090)
<b>2.95</b>	$\leq 2$	11600	0.060 (0.040–0.090)

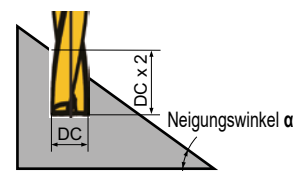

Hinweis 1) Die empfohlene Bohrtiefe beträgt  $DC \times 2$ . Dies sollte die Tiefe ab der obersten Fläche des Werkstücks sein, wenn angewinkelte Oberflächen bearbeitet werden. (Siehe Diagramm)

Hinweis 2) Die Schnittdatentabelle oben gilt für Bohrungen auf einer flachen Oberfläche.

Bei Bohrungen auf einer abgewinkelten Fläche muss die Vorschubgeschwindigkeit entsprechend dem Neigungswinkel angepasst werden. Wenn der Neigungswinkel  $\alpha \leq 30^\circ$  beträgt, muss die Vorschubgeschwindigkeit als Richtwert auf 70 % oder weniger reduziert werden.

Bei einem Neigungswinkel  $\alpha > 30^\circ$ , muss die Vorschubgeschwindigkeit als Richtwert auf 50 % oder weniger reduziert werden.

Hinweis 3) Bei diesem Produkt handelt es sich um ein Werkzeug, das für Bohrungen gedacht ist. Es kann nicht für Nutenbearbeitung- oder Helixbohren verwendet werden.

# BOHREN (VOLLHARTMETALL)

## DFAS NEW

Vollhartmetall-Flachbohrer



P M K N S H

Interne Kühlung

BOHREN

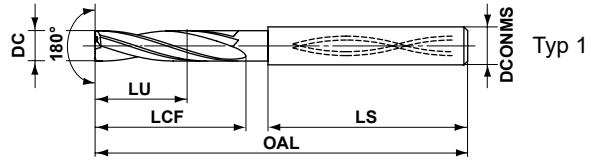

	DC=3	3 < DC ≤ 6	6 < DC ≤ 10	10 < DC ≤ 14
	$\begin{matrix} 0 \\ -0.014 \end{matrix}$	$\begin{matrix} 0 \\ -0.018 \end{matrix}$	$\begin{matrix} 0 \\ -0.022 \end{matrix}$	$\begin{matrix} 0 \\ -0.027 \end{matrix}$
	4 < DCONMS ≤ 6	6 < DCONMS ≤ 10	10 < DCONMS ≤ 14	
	$\begin{matrix} 0 \\ -0.008 \end{matrix}$	$\begin{matrix} 0 \\ -0.009 \end{matrix}$	$\begin{matrix} 0 \\ -0.011 \end{matrix}$	

DC (mm)	Bohrtiefe (L/D)	DP102A	Bestellnummer	Abmessungen (mm)					Typ
				LU	LCF	LS	OAL	DCONMS	
3.0	3	●	DFAS0300X03S040	9.0	14	39.0	55	4	1
3.1	3	★	DFAS0310X03S040	9.3	16	37.0	55	4	1
3.2	3	★	DFAS0320X03S040	9.6	16	37.0	55	4	1
3.3	3	●	DFAS0330X03S040	9.9	16	37.0	55	4	1
3.4	3	★	DFAS0340X03S040	10.2	16	37.0	55	4	1
3.5	3	●	DFAS0350X03S040	10.5	16	37.0	55	4	1
3.6	3	★	DFAS0360X03S040	10.8	18	35.0	55	4	1
3.7	3	★	DFAS0370X03S040	11.1	18	35.0	55	4	1
3.8	3	★	DFAS0380X03S040	11.4	18	35.0	55	4	1
3.9	3	★	DFAS0390X03S040	11.7	18	35.0	55	4	1
4.0	3	●	DFAS0400X03S040	12.0	18	35.0	55	4	1
4.1	3	★	DFAS0410X03S050	12.3	20	40.0	62	5	1
4.2	3	●	DFAS0420X03S050	12.6	20	40.0	62	5	1
4.3	3	★	DFAS0430X03S050	12.9	20	40.0	62	5	1
4.4	3	★	DFAS0440X03S050	13.2	20	40.0	62	5	1
4.5	3	●	DFAS0450X03S050	13.5	20	40.0	62	5	1
4.6	3	★	DFAS0460X03S050	13.8	23	37.0	62	5	1
4.7	3	★	DFAS0470X03S050	14.1	23	37.0	62	5	1
4.8	3	★	DFAS0480X03S050	14.4	23	37.0	62	5	1
4.9	3	★	DFAS0490X03S050	14.7	23	37.0	62	5	1
5.0	3	●	DFAS0500X03S050	15.0	23	37.0	62	5	1
5.1	3	★	DFAS0510X03S060	15.3	25	39.0	66	6	1
5.2	3	★	DFAS0520X03S060	15.6	25	39.0	66	6	1
5.3	3	●	DFAS0530X03S060	15.9	25	39.0	66	6	1
5.4	3	★	DFAS0540X03S060	16.2	25	39.0	66	6	1
5.5	3	●	DFAS0550X03S060	16.5	25	39.0	66	6	1
5.6	3	★	DFAS0560X03S060	16.8	27	37.0	66	6	1
5.7	3	★	DFAS0570X03S060	17.1	27	37.0	66	6	1
5.8	3	★	DFAS0580X03S060	17.4	27	37.0	66	6	1
5.9	3	★	DFAS0590X03S060	17.7	27	37.0	66	6	1

● : Lagerstandard. ★ : Lagerstandard in Japan.

DC (mm)	Bohrtiefe (L/D)	DP102A	Bestellnummer	Abmessungen (mm)					Typ
				LU	LCF	LS	OAL	DCONMS	
6.0	3	●	DFAS0600X03S060	18.0	27	37.0	66	6	1
6.1	3	★	DFAS0610X03S070	18.3	29	44.0	75	7	1
6.2	3	★	DFAS0620X03S070	18.6	29	44.0	75	7	1
6.3	3	★	DFAS0630X03S070	18.9	29	44.0	75	7	1
6.4	3	★	DFAS0640X03S070	19.2	29	44.0	75	7	1
6.5	3	●	DFAS0650X03S070	19.5	29	44.0	75	7	1
6.6	3	★	DFAS0660X03S070	19.8	32	41.0	75	7	1
6.7	3	★	DFAS0670X03S070	20.1	32	41.0	75	7	1
6.8	3	●	DFAS0680X03S070	20.4	32	41.0	75	7	1
6.9	3	★	DFAS0690X03S070	20.7	32	41.0	75	7	1
7.0	3	●	DFAS0700X03S070	21.0	32	41.0	75	7	1
7.1	3	★	DFAS0710X03S080	21.3	34	44.0	80	8	1
7.2	3	★	DFAS0720X03S080	21.6	34	44.0	80	8	1
7.3	3	★	DFAS0730X03S080	21.9	34	44.0	80	8	1
7.4	3	★	DFAS0740X03S080	22.2	34	44.0	80	8	1
7.5	3	●	DFAS0750X03S080	22.5	34	44.0	80	8	1
7.6	3	★	DFAS0760X03S080	22.8	36	42.0	80	8	1
7.7	3	★	DFAS0770X03S080	23.1	36	42.0	80	8	1
7.8	3	★	DFAS0780X03S080	23.4	36	42.0	80	8	1
7.9	3	★	DFAS0790X03S080	23.7	36	42.0	80	8	1
8.0	3	●	DFAS0800X03S080	24.0	36	42.0	80	8	1
8.1	3	★	DFAS0810X03S090	24.3	38	45.0	85	9	1
8.2	3	●	DFAS0820X03S090	24.6	38	45.0	85	9	1
8.3	3	★	DFAS0830X03S090	24.9	38	45.0	85	9	1
8.4	3	★	DFAS0840X03S090	25.2	38	45.0	85	9	1
8.5	3	●	DFAS0850X03S090	25.5	38	45.0	85	9	1
8.6	3	★	DFAS0860X03S090	25.8	41	42.0	85	9	1
8.7	3	★	DFAS0870X03S090	26.1	41	42.0	85	9	1
8.8	3	●	DFAS0880X03S090	26.4	41	42.0	85	9	1
8.9	3	★	DFAS0890X03S090	26.7	41	42.0	85	9	1
9.0	3	●	DFAS0900X03S090	27.0	41	42.0	85	9	1
9.1	3	★	DFAS0910X03S100	27.3	43	45.0	90	10	1
9.2	3	★	DFAS0920X03S100	27.6	43	45.0	90	10	1
9.3	3	★	DFAS0930X03S100	27.9	43	45.0	90	10	1
9.4	3	★	DFAS0940X03S100	28.2	43	45.0	90	10	1
9.5	3	●	DFAS0950X03S100	28.5	43	45.0	90	10	1
9.6	3	★	DFAS0960X03S100	28.8	45	43.0	90	10	1
9.7	3	●	DFAS0970X03S100	29.1	45	43.0	90	10	1
9.8	3	★	DFAS0980X03S100	29.4	45	43.0	90	10	1
9.9	3	★	DFAS0990X03S100	29.7	45	43.0	90	10	1

M

BOHREN

# BOHREN (VOLLHARTMETALL)

## DFAS NEW

Vollhartmetall-Flachbohrer

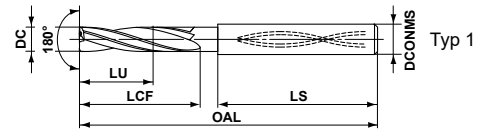

DC (mm)	Bohrtiefe (L/D)	DP102A	Bestellnummer	Abmessungen (mm)					Typ
				LU	LCF	LS	OAL	DCONMS	
10.0	3	●	DFAS1000X03S100	30.0	45	43.0	90	10	1
10.1	3	★	DFAS1010X03S110	30.3	47	52.0	101	11	1
10.2	3	●	DFAS1020X03S110	30.6	47	52.0	101	11	1
10.3	3	★	DFAS1030X03S110	30.9	47	52.0	101	11	1
10.4	3	★	DFAS1040X03S110	31.2	47	52.0	101	11	1
10.5	3	●	DFAS1050X03S110	31.5	47	52.0	101	11	1
10.6	3	★	DFAS1060X03S110	31.8	50	49.0	101	11	1
10.7	3	★	DFAS1070X03S110	32.1	50	49.0	101	11	1
10.8	3	★	DFAS1080X03S110	32.4	50	49.0	101	11	1
10.9	3	★	DFAS1090X03S110	32.7	50	49.0	101	11	1
11.0	3	●	DFAS1100X03S110	33.0	50	49.0	101	11	1
11.1	3	★	DFAS1110X03S120	33.3	52	51.0	105	12	1
11.2	3	★	DFAS1120X03S120	33.6	52	51.0	105	12	1
11.3	3	★	DFAS1130X03S120	33.9	52	51.0	105	12	1
11.4	3	★	DFAS1140X03S120	34.2	52	51.0	105	12	1
11.5	3	●	DFAS1150X03S120	34.5	52	51.0	105	12	1
11.6	3	★	DFAS1160X03S120	34.8	54	49.0	105	12	1
11.7	3	★	DFAS1170X03S120	35.1	54	49.0	105	12	1
11.8	3	★	DFAS1180X03S120	35.4	54	49.0	105	12	1
11.9	3	★	DFAS1190X03S120	35.7	54	49.0	105	12	1
12.0	3	●	DFAS1200X03S120	36.0	54	49.0	105	12	1
12.5	3	★	DFAS1250X03S130	37.5	56	52.0	110	13	1
13.0	3	●	DFAS1300X03S130	39.0	59	49.0	110	13	1
13.5	3	★	DFAS1350X03S140	40.5	61	51.0	114	14	1
14.0	3	●	DFAS1400X03S140	42.0	63	49.0	114	14	1

● : Lagerstandard. ★ : Lagerstandard in Japan.

## SCHNITTDATENEMPFEHLUNGEN

Material		P		M		K	
		Allg. Baustahl, C-Stahl, Leg. Stahl		Rostfreier Stahl, PH Rostfreier Stahl X5CrNi18-10, X5CrNiMo17-12-2, 17-4PH, X7CrNiAl17-7		Grauguss, Duktiler Guss	
		St44-2, C10, 41CrMo4, 40CrNiMoA				GG-30, GGG-40	
Bohrer Durchm. DC (mm)	L/D	Drehzahl (min <sup>-1</sup> )	$\alpha=0^\circ$ Vorschub (min.–max.) (mm/U.)	Drehzahl (min <sup>-1</sup> )	$\alpha=0^\circ$ Vorschub (min.–max.) (mm/U.)	Drehzahl (min <sup>-1</sup> )	$\alpha=0^\circ$ Vorschub (min.–max.) (mm/U.)
3.0	≤3	10610	0.07 (0.04–0.10)	3180	0.05 (0.04–0.06)	10610	0.04 (0.02–0.07)
4.0	≤3	7960	0.08 (0.04–0.11)	2390	0.06 (0.05–0.08)	7960	0.05 (0.03–0.09)
5.0	≤3	6370	0.10 (0.05–0.14)	1910	0.08 (0.06–0.10)	6370	0.07 (0.03–0.11)
6.0	≤3	5310	0.12 (0.06–0.17)	1590	0.10 (0.08–0.12)	5310	0.08 (0.04–0.13)
7.0	≤3	4550	0.13 (0.07–0.20)	1360	0.11 (0.09–0.14)	4550	0.09 (0.05–0.15)
8.0	≤3	3980	0.16 (0.08–0.23)	1190	0.13 (0.10–0.16)	3980	0.11 (0.05–0.17)
9.0	≤3	3540	0.17 (0.09–0.26)	1060	0.15 (0.12–0.18)	3540	0.12 (0.06–0.20)
10.0	≤3	3180	0.20 (0.10–0.29)	950	0.16 (0.13–0.20)	3180	0.13 (0.07–0.22)
11.0	≤3	2890	0.22 (0.11–0.32)	870	0.18 (0.14–0.22)	2890	0.15 (0.07–0.24)
12.0	≤3	2650	0.24 (0.12–0.35)	800	0.20 (0.16–0.24)	2650	0.16 (0.08–0.26)
13.0	≤3	2450	0.26 (0.13–0.39)	730	0.22 (0.17–0.26)	2450	0.17 (0.09–0.28)
14.0	≤3	2270	0.28 (0.14–0.42)	680	0.23 (0.19–0.28)	2270	0.19 (0.09–0.30)

Material		N		S	
		Aluminiumleg.		Titanlegierung	
		AlMg1SiCu, Al-Zn6MgCu		Ti-6Al-4V, Ti-5Al-5V-5Mo-3Cr	
Bohrer Durchm. DC (mm)	L/D	Drehzahl (min <sup>-1</sup> )	$\alpha=0^\circ$ Vorschub (min.–max.) (mm/U.)	Drehzahl (min <sup>-1</sup> )	$\alpha=0^\circ$ Vorschub (min.–max.) (mm/U.)
3.0	≤3	13790	0.04 (0.02–0.07)	3710	0.03 (0.01–0.05)
4.0	≤3	10350	0.05 (0.03–0.09)	2790	0.04 (0.01–0.07)
5.0	≤3	8280	0.07 (0.03–0.11)	2230	0.05 (0.02–0.08)
6.0	≤3	6900	0.08 (0.04–0.13)	1860	0.06 (0.02–0.10)
7.0	≤3	5910	0.09 (0.05–0.15)	1590	0.07 (0.02–0.12)
8.0	≤3	5170	0.11 (0.05–0.17)	1390	0.08 (0.03–0.13)
9.0	≤3	4600	0.12 (0.06–0.20)	1240	0.09 (0.03–0.15)
10.0	≤3	4140	0.13 (0.07–0.22)	1110	0.10 (0.03–0.17)
11.0	≤3	3760	0.15 (0.07–0.24)	1010	0.11 (0.04–0.18)
12.0	≤3	3450	0.16 (0.08–0.26)	930	0.12 (0.04–0.20)
13.0	≤3	3180	0.17 (0.09–0.28)	860	0.13 (0.04–0.22)
14.0	≤3	2960	0.19 (0.09–0.30)	800	0.14 (0.05–0.23)

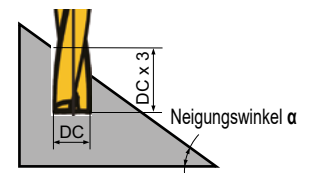

Hinweis 1) Die empfohlene Bohrtiefe beträgt  $DC \times 3$ . Dies sollte die Tiefe ab der obersten Fläche des Werkstücks sein, wenn abgewinkelte Oberflächen bearbeitet werden. (Siehe Diagramm)

Hinweis 2) Die obige Schnittdatentabelle gilt für Bohrungen auf einer flachen Oberfläche.

Bei Bohrungen auf einer abgewinkelten Fläche muss die Vorschubgeschwindigkeit entsprechend dem Neigungswinkel angepasst werden.

Wenn der Neigungswinkel  $\alpha$   $30^\circ$  oder weniger beträgt, die Vorschubgeschwindigkeit als Richtwert um 30 % oder mehr reduzieren.

Wenn der Neigungswinkel  $\alpha$  mehr als  $30^\circ$  beträgt, die Vorschubgeschwindigkeit als Richtwert um 50 % oder mehr reduzieren.

Hinweis 3) Bei der Bearbeitung von rostfreiem Stahl mit flacher Oberfläche muss zuerst ein Führungsloch mit demselben Durchmesser gebohrt oder eine Spitzsenkung gearbeitet werden.

Hinweis 4) Bei diesem Produkt handelt es sich um ein Werkzeug, das für Bohrungen gedacht ist. Es kann nicht für Quervorschub- oder Helixbohren verwendet werden.

# BOHREN (VOLLHARTMETALL)

# MINI-DWAE

Minibohrer



DC<2.0

- P
- M
- K
- N
- S
- H

Externe Kühlung



DC<2.0



DC≥2.0

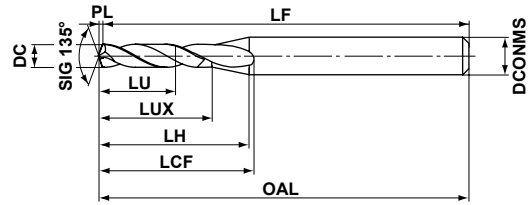

Typ 1

M

BOHREN



h6

DC ≤ 3	
0	
-0.014	
DCONMS=3	DCONMS=4
0	0
-0.006	-0.008

DC (mm)	Bohr- tiefe (L/D)	DP102A	Bestellnummer	Abmessungen (mm)								Typ
				LU	LUX	LCF	LH	OAL	LF	PL	DCONMS	
1.0	2	●	DWAE0100X02S030	2.2	5.0	7.7	8.7	45.0	44.8	0.2	3	1
1.0	4	●	DWAE0100X04S030	4.2	7.0	9.9	10.7	45.0	44.8	0.2	3	1
1.1	2	★	DWAE0110X02S030	2.4	5.4	8.1	8.9	45.0	44.8	0.2	3	1
1.1	4	★	DWAE0110X04S030	4.6	7.6	10.5	11.1	45.0	44.8	0.2	3	1
1.2	2	★	DWAE0120X02S030	2.6	5.8	8.5	9.2	45.0	44.8	0.2	3	1
1.2	4	★	DWAE0120X04S030	5.0	8.2	11.1	11.6	45.0	44.8	0.2	3	1
1.3	2	★	DWAE0130X02S030	2.9	6.3	9.0	9.5	45.0	44.7	0.3	3	1
1.3	4	★	DWAE0130X04S030	5.5	8.9	11.9	12.1	45.0	44.7	0.3	3	1
1.4	2	★	DWAE0140X02S030	3.1	6.7	9.4	9.7	45.0	44.7	0.3	3	1
1.4	4	★	DWAE0140X04S030	5.9	9.5	12.5	12.5	45.0	44.7	0.3	3	1
1.5	2	●	DWAE0150X02S030	3.3	7.1	9.8	9.9	45.0	44.7	0.3	3	1
1.5	4	●	DWAE0150X04S030	6.3	10.1	13.1	12.9	45.0	44.7	0.3	3	1
1.6	2	★	DWAE0160X02S030	3.5	7.5	10.2	10.1	45.0	44.7	0.3	3	1
1.6	4	★	DWAE0160X04S030	6.7	10.7	13.7	13.3	45.0	44.7	0.3	3	1
1.7	2	★	DWAE0170X02S030	3.8	8.0	10.7	10.4	45.0	44.6	0.4	3	1
1.7	4	★	DWAE0170X04S030	7.2	11.4	14.4	13.8	45.0	44.6	0.4	3	1
1.8	2	★	DWAE0180X02S030	4.0	8.4	11.1	10.6	45.0	44.6	0.4	3	1
1.8	4	★	DWAE0180X04S030	7.6	12.0	15.1	14.2	45.0	44.6	0.4	3	1
1.9	2	★	DWAE0190X02S030	4.2	8.8	11.5	10.9	45.0	44.6	0.4	3	1
1.9	4	★	DWAE0190X04S030	8.0	12.6	15.7	14.7	45.0	44.6	0.4	3	1
2.0	2	●	DWAE0200X02S040	4.4	9.2	12.8	12.9	50.0	49.6	0.4	4	1
2.0	4	●	DWAE0200X04S040	8.4	13.2	17.2	16.9	50.0	49.6	0.4	4	1
2.1	2	★	DWAE0210X02S040	4.6	9.6	13.2	13.1	50.0	49.6	0.4	4	1
2.1	4	★	DWAE0210X04S040	8.8	13.8	17.8	17.3	50.0	49.6	0.4	4	1
2.2	2	★	DWAE0220X02S040	4.9	10.1	13.7	13.5	50.0	49.5	0.5	4	1
2.2	4	★	DWAE0220X04S040	9.3	14.5	18.5	17.9	50.0	49.5	0.5	4	1
2.3	2	★	DWAE0230X02S040	5.1	10.5	14.1	13.7	50.0	49.5	0.5	4	1
2.3	4	★	DWAE0230X04S040	9.7	15.1	19.2	18.3	50.0	49.5	0.5	4	1
2.4	2	★	DWAE0240X02S040	5.3	10.9	14.5	13.9	50.0	49.5	0.5	4	1
2.4	4	★	DWAE0240X04S040	10.1	15.7	19.8	18.7	50.0	49.5	0.5	4	1
2.5	2	●	DWAE0250X02S040	5.5	11.3	14.9	14.1	50.0	49.5	0.5	4	1
2.5	4	●	DWAE0250X04S040	10.5	16.3	20.4	19.1	50.0	49.5	0.5	4	1
2.6	2	★	DWAE0260X02S040	5.7	11.7	15.3	14.3	50.0	49.5	0.5	4	1
2.6	4	★	DWAE0260X04S040	10.9	16.9	21.0	19.5	50.0	49.5	0.5	4	1
2.7	2	★	DWAE0270X02S040	6.0	12.2	15.8	14.6	50.0	49.4	0.6	4	1
2.7	4	★	DWAE0270X04S040	11.4	17.6	21.7	20.0	50.0	49.4	0.6	4	1
2.8	2	★	DWAE0280X02S040	6.2	12.6	16.2	14.8	50.0	49.4	0.6	4	1
2.8	4	★	DWAE0280X04S040	11.8	18.2	22.4	20.4	50.0	49.4	0.6	4	1
2.9	2	★	DWAE0290X02S040	6.4	13.0	16.6	15.1	50.0	49.4	0.6	4	1
2.9	4	★	DWAE0290X04S040	12.2	18.8	23.0	20.9	50.0	49.4	0.6	4	1

● : Lagerstandard. ★ : Lagerstandard in Japan.

P M **K** N S H

Externe Kühlung

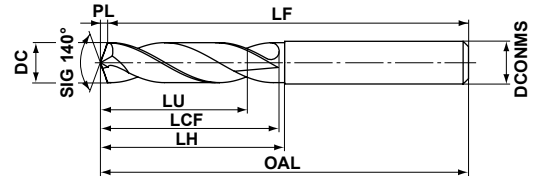

DC=3	3<DC≤6	6<DC≤10	10<DC≤14
$\frac{0}{-0.014}$	$\frac{0}{-0.018}$	$\frac{0}{-0.022}$	$\frac{0}{-0.027}$



DCONMS=3	3<DCONMS≤6	6<DCONMS≤10	10<DCONMS≤14
$\frac{0}{-0.006}$	$\frac{0}{-0.008}$	$\frac{0}{-0.009}$	$\frac{0}{-0.011}$

DC (mm)	Bohr- tiefe (L/D)	DP102A	Bestellnummer	Abmessungen (mm)							Typ
				LU	LCF	LH	OAL	LF	PL	DCONMS	
3.0	2	●	DWAE0300X02S030	6.5	12.5	14.5	45.5	45	0.5	3	1
3.0	4	●	DWAE0300X04S030	12.5	21.5	23.5	55.5	55	0.5	3	1
3.1	2	●	DWAE0310X02S040	6.8	12.6	14.6	55.6	55	0.6	4	1
3.1	4	●	DWAE0310X04S040	13.0	21.6	23.6	60.6	60	0.6	4	1
3.2	2	●	DWAE0320X02S040	7.0	13.6	15.6	55.6	55	0.6	4	1
3.2	4	●	DWAE0320X04S040	13.4	22.6	24.6	60.6	60	0.6	4	1
3.3	2	●	DWAE0330X02S040	7.2	13.6	15.6	55.6	55	0.6	4	1
3.3	4	●	DWAE0330X04S040	13.8	23.6	25.6	60.6	60	0.6	4	1
3.4	2	●	DWAE0340X02S040	7.4	13.6	15.6	55.6	55	0.6	4	1
3.4	4	●	DWAE0340X04S040	14.2	23.6	25.6	60.6	60	0.6	4	1
3.5	2	●	DWAE0350X02S040	7.6	14.6	16.6	55.6	55	0.6	4	1
3.5	4	●	DWAE0350X04S040	14.6	24.6	26.6	60.6	60	0.6	4	1
3.6	2	●	DWAE0360X02S040	7.9	14.7	16.7	55.7	55	0.7	4	1
3.6	4	●	DWAE0360X04S040	15.1	25.7	27.7	60.7	60	0.7	4	1
3.7	2	●	DWAE0370X02S040	8.1	14.7	16.7	55.7	55	0.7	4	1
3.7	4	●	DWAE0370X04S040	15.5	25.7	27.7	60.7	60	0.7	4	1
3.8	2	●	DWAE0380X02S040	8.3	15.7	17.7	55.7	55	0.7	4	1
3.8	4	●	DWAE0380X04S040	15.9	26.7	28.7	60.7	60	0.7	4	1
3.9	2	●	DWAE0390X02S040	8.5	15.7	17.7	55.7	55	0.7	4	1
3.9	4	●	DWAE0390X04S040	16.3	27.7	29.7	60.7	60	0.7	4	1
4.0	2	●	DWAE0400X02S040	8.7	15.7	17.7	55.7	55	0.7	4	1
4.0	4	●	DWAE0400X04S040	16.7	27.7	29.7	60.7	60	0.7	4	1
4.1	2	●	DWAE0410X02S050	8.9	16.7	18.7	62.7	62	0.7	5	1
4.1	4	●	DWAE0410X04S050	17.1	28.7	30.7	80.7	80	0.7	5	1
4.2	2	●	DWAE0420X02S050	9.2	16.8	18.8	62.8	62	0.8	5	1
4.2	4	●	DWAE0420X04S050	17.6	29.8	31.8	80.8	80	0.8	5	1
4.3	2	●	DWAE0430X02S050	9.4	17.8	19.8	62.8	62	0.8	5	1
4.3	4	●	DWAE0430X04S050	18.0	30.8	32.8	80.8	80	0.8	5	1
4.4	2	●	DWAE0440X02S050	9.6	17.8	19.8	62.8	62	0.8	5	1
4.4	4	●	DWAE0440X04S050	18.4	30.8	32.8	80.8	80	0.8	5	1

# BOHREN (VOLLHARTMETALL)

# DWAE

HARTMETALL

M  
BOHREN

DC (mm)	Bohr- tiefe (L/D)	DP-102A	Bestellnummer	Abmessungen (mm)							Typ
				LU	LCF	LH	OAL	LF	PL	DCONMS	
4.5	2	●	DWAE0450X02S050	9.8	17.8	19.8	62.8	62	0.8	5	1
4.5	4	●	DWAE0450X04S050	18.8	31.8	33.8	80.8	80	0.8	5	1
4.6	2	●	DWAE0460X02S050	10.0	18.8	20.8	62.8	62	0.8	5	1
4.6	4	●	DWAE0460X04S050	19.2	32.8	34.8	80.8	80	0.8	5	1
4.7	2	●	DWAE0470X02S050	10.3	18.9	20.9	62.9	62	0.9	5	1
4.7	4	●	DWAE0470X04S050	19.7	32.9	34.9	80.9	80	0.9	5	1
4.8	2	●	DWAE0480X02S050	10.5	18.9	20.9	62.9	62	0.9	5	1
4.8	4	●	DWAE0480X04S050	20.1	33.9	35.9	80.9	80	0.9	5	1
4.9	2	●	DWAE0490X02S050	10.7	19.9	21.9	62.9	62	0.9	5	1
4.9	4	●	DWAE0490X04S050	20.5	34.9	36.9	80.9	80	0.9	5	1
5.0	2	●	DWAE0500X02S050	10.9	19.9	21.9	62.9	62	0.9	5	1
5.0	4	●	DWAE0500X04S050	20.9	34.9	36.9	80.9	80	0.9	5	1
5.1	2	★	DWAE0510X02S060	11.1	21.9	23.9	66.9	66	0.9	6	1
5.1	4	★	DWAE0510X04S060	21.3	35.9	37.9	80.9	80	0.9	6	1
5.2	2	●	DWAE0520X02S060	11.3	21.9	23.9	66.9	66	0.9	6	1
5.2	4	●	DWAE0520X04S060	21.7	36.9	38.9	80.9	80	0.9	6	1
5.3	2	★	DWAE0530X02S060	11.6	22.0	24.0	67.0	66	1.0	6	1
5.3	4	★	DWAE0530X04S060	22.2	37.0	39.0	81.0	80	1.0	6	1
5.4	2	●	DWAE0540X02S060	11.8	22.0	24.0	67.0	66	1.0	6	1
5.4	4	●	DWAE0540X04S060	22.6	38.0	40.0	81.0	80	1.0	6	1
5.5	2	★	DWAE0550X02S060	12.0	22.0	24.0	67.0	66	1.0	6	1
5.5	4	★	DWAE0550X04S060	23.0	39.0	41.0	81.0	80	1.0	6	1
5.6	2	●	DWAE0560X02S060	12.2	24.0	26.0	67.0	66	1.0	6	1
5.6	4	●	DWAE0560X04S060	23.4	39.0	41.0	81.0	80	1.0	6	1
5.7	2	★	DWAE0570X02S060	12.4	24.0	26.0	67.0	66	1.0	6	1
5.7	4	★	DWAE0570X04S060	23.8	39.0	41.0	81.0	80	1.0	6	1
5.8	2	●	DWAE0580X02S060	12.7	24.1	26.1	67.1	66	1.1	6	1
5.8	4	●	DWAE0580X04S060	24.3	41.1	43.1	81.1	80	1.1	6	1
5.9	2	★	DWAE0590X02S060	12.9	24.1	26.1	67.1	66	1.1	6	1
5.9	4	★	DWAE0590X04S060	24.7	41.1	43.1	81.1	80	1.1	6	1
6.0	2	●	DWAE0600X02S060	13.1	24.1	26.1	67.1	66	1.1	6	1
6.0	4	●	DWAE0600X04S060	25.1	42.1	44.1	81.1	80	1.1	6	1
6.1	2	★	DWAE0610X02S070	13.3	26.1	28.1	75.1	74	1.1	7	1
6.1	4	★	DWAE0610X04S070	25.5	44.1	46.1	84.1	83	1.1	7	1
6.2	2	●	DWAE0620X02S070	13.5	26.1	28.1	75.1	74	1.1	7	1
6.2	4	●	DWAE0620X04S070	25.9	44.1	46.1	84.1	83	1.1	7	1
6.3	2	★	DWAE0630X02S070	13.7	26.1	28.1	75.1	74	1.1	7	1
6.3	4	★	DWAE0630X04S070	26.3	44.1	46.1	84.1	83	1.1	7	1
6.4	2	●	DWAE0640X02S070	14.0	26.2	28.2	75.2	74	1.2	7	1
6.4	4	●	DWAE0640X04S070	26.8	44.2	46.2	84.2	83	1.2	7	1
6.5	2	★	DWAE0650X02S070	14.2	26.2	28.2	75.2	74	1.2	7	1
6.5	4	★	DWAE0650X04S070	27.2	44.2	46.2	84.2	83	1.2	7	1

● : Lagerstandard. ★ : Lagerstandard in Japan.



DC (mm)	Bohr- tiefe (L/D)	DP-102A	Bestellnummer	Abmessungen (mm)							Typ
				LU	LCF	LH	OAL	LF	PL	DCONMS	
6.6	2	●	DWAE0660X02S070	14.4	28.2	30.2	75.2	74	1.2	7	1
6.6	4	●	DWAE0660X04S070	27.6	46.2	48.2	84.2	83	1.2	7	1
6.7	2	★	DWAE0670X02S070	14.6	28.2	30.2	75.2	74	1.2	7	1
6.7	4	★	DWAE0670X04S070	28.0	46.2	48.2	84.2	83	1.2	7	1
6.8	2	●	DWAE0680X02S070	14.8	28.2	30.2	75.2	74	1.2	7	1
6.8	4	●	DWAE0680X04S070	28.4	46.2	48.2	84.2	83	1.2	7	1
6.9	2	★	DWAE0690X02S070	15.1	28.3	30.3	75.3	74	1.3	7	1
6.9	4	★	DWAE0690X04S070	28.9	46.3	48.3	84.3	83	1.3	7	1
7.0	2	●	DWAE0700X02S070	15.3	28.3	30.3	75.3	74	1.3	7	1
7.0	4	●	DWAE0700X04S070	29.3	46.3	48.3	84.3	83	1.3	7	1
7.1	2	★	DWAE0710X02S080	15.5	29.3	31.3	80.3	79	1.3	8	1
7.1	4	★	DWAE0710X04S080	29.7	51.3	53.3	91.3	90	1.3	8	1
7.2	2	●	DWAE0720X02S080	15.7	29.3	31.3	80.3	79	1.3	8	1
7.2	4	●	DWAE0720X04S080	30.1	51.3	53.3	91.3	90	1.3	8	1
7.3	2	★	DWAE0730X02S080	15.9	29.3	31.3	80.3	79	1.3	8	1
7.3	4	★	DWAE0730X04S080	30.5	51.3	53.3	91.3	90	1.3	8	1
7.4	2	●	DWAE0740X02S080	16.1	29.3	31.3	80.3	79	1.3	8	1
7.4	4	●	DWAE0740X04S080	30.9	51.3	53.3	91.3	90	1.3	8	1
7.5	2	★	DWAE0750X02S080	16.4	29.4	31.4	80.4	79	1.4	8	1
7.5	4	★	DWAE0750X04S080	31.4	51.4	53.4	91.4	90	1.4	8	1
7.6	2	●	DWAE0760X02S080	16.6	31.4	33.4	80.4	79	1.4	8	1
7.6	4	●	DWAE0760X04S080	31.8	53.4	55.4	91.4	90	1.4	8	1
7.7	2	★	DWAE0770X02S080	16.8	31.4	33.4	80.4	79	1.4	8	1
7.7	4	★	DWAE0770X04S080	32.2	53.4	55.4	91.4	90	1.4	8	1
7.8	2	●	DWAE0780X02S080	17.0	31.4	33.4	80.4	79	1.4	8	1
7.8	4	●	DWAE0780X04S080	32.6	53.4	55.4	91.4	90	1.4	8	1
7.9	2	★	DWAE0790X02S080	17.2	31.4	33.4	80.4	79	1.4	8	1
7.9	4	★	DWAE0790X04S080	33.0	53.4	55.4	91.4	90	1.4	8	1
8.0	2	●	DWAE0800X02S080	17.5	31.5	33.5	80.5	79	1.5	8	1
8.0	4	●	DWAE0800X04S080	33.5	53.5	55.5	91.5	90	1.5	8	1
8.1	2	★	DWAE0810X02S090	17.7	33.5	35.5	85.5	84	1.5	9	1
8.1	4	★	DWAE0810X04S090	33.9	57.5	59.5	99.5	98	1.5	9	1
8.2	2	●	DWAE0820X02S090	17.9	33.5	35.5	85.5	84	1.5	9	1
8.2	4	●	DWAE0820X04S090	34.3	57.5	59.5	99.5	98	1.5	9	1
8.3	2	★	DWAE0830X02S090	18.1	33.5	35.5	85.5	84	1.5	9	1
8.3	4	★	DWAE0830X04S090	34.7	57.5	59.5	99.5	98	1.5	9	1
8.4	2	●	DWAE0840X02S090	18.3	33.5	35.5	85.5	84	1.5	9	1
8.4	4	●	DWAE0840X04S090	35.1	57.5	59.5	99.5	98	1.5	9	1
8.5	2	★	DWAE0850X02S090	18.5	33.5	35.5	85.5	84	1.5	9	1
8.5	4	★	DWAE0850X04S090	35.5	57.5	59.5	99.5	98	1.5	9	1
8.6	2	●	DWAE0860X02S090	18.8	34.6	36.6	85.6	84	1.6	9	1
8.6	4	●	DWAE0860X04S090	36.0	61.6	63.6	99.6	98	1.6	9	1
8.7	2	★	DWAE0870X02S090	19.0	34.6	36.6	85.6	84	1.6	9	1
8.7	4	★	DWAE0870X04S090	36.4	61.6	63.6	99.6	98	1.6	9	1

M

BOHREN

# BOHREN (VOLLHARTMETALL)

# DWAE

HARTMETALL

M  
BOHREN

DC (mm)	Bohr- tiefe (L/D)	DP-102A	Bestellnummer	Abmessungen (mm)							Typ
				LU	LCF	LH	OAL	LF	PL	DCONMS	
8.8	2	●	DWAE0880X02S090	19.2	34.6	36.6	85.6	84	1.6	9	1
8.8	4	●	DWAE0880X04S090	36.8	61.6	63.6	99.6	98	1.6	9	1
8.9	2	★	DWAE0890X02S090	19.4	34.6	36.6	85.6	84	1.6	9	1
8.9	4	★	DWAE0890X04S090	37.2	61.6	63.6	99.6	98	1.6	9	1
9.0	2	●	DWAE0900X02S090	19.6	34.6	36.6	85.6	84	1.6	9	1
9.0	4	●	DWAE0900X04S090	37.6	61.6	63.6	99.6	98	1.6	9	1
9.1	2	★	DWAE0910X02S100	19.9	36.7	38.7	90.7	89	1.7	10	1
9.1	4	★	DWAE0910X04S100	38.1	63.7	65.7	106.7	105	1.7	10	1
9.2	2	●	DWAE0920X02S100	20.1	36.7	38.7	90.7	89	1.7	10	1
9.2	4	●	DWAE0920X04S100	38.5	63.7	65.7	106.7	105	1.7	10	1
9.3	2	★	DWAE0930X02S100	20.3	36.7	38.7	90.7	89	1.7	10	1
9.3	4	★	DWAE0930X04S100	38.9	63.7	65.7	106.7	105	1.7	10	1
9.4	2	●	DWAE0940X02S100	20.5	36.7	38.7	90.7	89	1.7	10	1
9.4	4	●	DWAE0940X04S100	39.3	63.7	65.7	106.7	105	1.7	10	1
9.5	2	★	DWAE0950X02S100	20.7	36.7	38.7	90.7	89	1.7	10	1
9.5	4	★	DWAE0950X04S100	39.7	63.7	65.7	106.7	105	1.7	10	1
9.6	2	●	DWAE0960X02S100	20.9	37.7	39.7	90.7	89	1.7	10	1
9.6	4	●	DWAE0960X04S100	40.1	66.7	68.7	106.7	105	1.7	10	1
9.7	2	★	DWAE0970X02S100	21.2	37.8	39.8	90.8	89	1.8	10	1
9.7	4	★	DWAE0970X04S100	40.6	66.8	68.8	106.8	105	1.8	10	1
9.8	2	●	DWAE0980X02S100	21.4	37.8	39.8	90.8	89	1.8	10	1
9.8	4	●	DWAE0980X04S100	41.0	66.8	68.8	106.8	105	1.8	10	1
9.9	2	★	DWAE0990X02S100	21.6	37.8	39.8	90.8	89	1.8	10	1
9.9	4	★	DWAE0990X04S100	41.4	66.8	68.8	106.8	105	1.8	10	1
10.0	2	●	DWAE1000X02S100	21.8	37.8	39.8	90.8	89	1.8	10	1
10.0	4	●	DWAE1000X04S100	41.8	66.8	68.8	106.8	105	1.8	10	1
10.1	2	●	DWAE1010X02S110	22.0	40.8	42.8	101.8	100	1.8	11	1
10.1	4	●	DWAE1010X04S110	42.2	71.8	73.8	115.8	114	1.8	11	1
10.2	2	●	DWAE1020X02S110	22.3	40.9	42.9	101.9	100	1.9	11	1
10.2	4	●	DWAE1020X04S110	42.7	71.9	73.9	115.9	114	1.9	11	1
10.3	2	●	DWAE1030X02S110	22.5	40.9	42.9	101.9	100	1.9	11	1
10.3	4	●	DWAE1030X04S110	43.1	71.9	73.9	115.9	114	1.9	11	1
10.4	2	●	DWAE1040X02S110	22.7	40.9	42.9	101.9	100	1.9	11	1
10.4	4	●	DWAE1040X04S110	43.5	71.9	73.9	115.9	114	1.9	11	1
10.5	2	●	DWAE1050X02S110	22.9	40.9	42.9	101.9	100	1.9	11	1
10.5	4	●	DWAE1050X04S110	43.9	71.9	73.9	115.9	114	1.9	11	1
10.6	2	●	DWAE1060X02S110	23.1	41.9	43.9	101.9	100	1.9	11	1
10.6	4	●	DWAE1060X04S110	44.3	72.9	74.9	115.9	114	1.9	11	1
10.7	2	●	DWAE1070X02S110	23.3	41.9	43.9	101.9	100	1.9	11	1
10.7	4	●	DWAE1070X04S110	44.7	72.9	74.9	115.9	114	1.9	11	1
10.8	2	●	DWAE1080X02S110	23.6	42.0	44.0	102.0	100	2.0	11	1
10.8	4	●	DWAE1080X04S110	45.2	73.0	75.0	116.0	114	2.0	11	1

● : Lagerstandard. ★ : Lagerstandard in Japan.

DC (mm)	Bohr- tiefe (L/D)	DP-102A	Bestellnummer	Abmessungen (mm)							Typ
				LU	LCF	LH	OAL	LF	PL	DCONMS	
10.9	2	●	DWAE1090X02S110	23.8	42.0	44.0	102.0	100	2.0	11	1
10.9	4	●	DWAE1090X04S110	45.6	73.0	75.0	116.0	114	2.0	11	1
11.0	2	●	DWAE1100X02S110	24.0	42.0	44.0	102.0	100	2.0	11	1
11.0	4	●	DWAE1100X04S110	46.0	73.0	75.0	116.0	114	2.0	11	1
11.1	2	●	DWAE1110X02S120	24.2	45.0	47.0	102.0	100	2.0	12	1
11.1	4	●	DWAE1110X04S120	46.4	77.0	79.0	123.0	121	2.0	12	1
11.2	2	●	DWAE1120X02S120	24.4	45.0	47.0	102.0	100	2.0	12	1
11.2	4	●	DWAE1120X04S120	46.8	77.0	79.0	123.0	121	2.0	12	1
11.3	2	●	DWAE1130X02S120	24.7	45.1	47.1	102.1	100	2.1	12	1
11.3	4	●	DWAE1130X04S120	47.3	77.1	79.1	123.1	121	2.1	12	1
11.4	2	●	DWAE1140X02S120	24.9	45.1	47.1	102.1	100	2.1	12	1
11.4	4	●	DWAE1140X04S120	47.7	77.1	79.1	123.1	121	2.1	12	1
11.5	2	●	DWAE1150X02S120	25.1	45.1	47.1	102.1	100	2.1	12	1
11.5	4	●	DWAE1150X04S120	48.1	77.1	79.1	123.1	121	2.1	12	1
11.6	2	●	DWAE1160X02S120	25.3	47.1	49.1	102.1	100	2.1	12	1
11.6	4	●	DWAE1160X04S120	48.5	79.1	81.1	123.1	121	2.1	12	1
11.7	2	●	DWAE1170X02S120	25.5	47.1	49.1	102.1	100	2.1	12	1
11.7	4	●	DWAE1170X04S120	48.9	79.1	81.1	123.1	121	2.1	12	1
11.8	2	●	DWAE1180X02S120	25.7	47.1	49.1	102.1	100	2.1	12	1
11.8	4	●	DWAE1180X04S120	49.3	79.1	81.1	123.1	121	2.1	12	1
11.9	2	●	DWAE1190X02S120	26.0	47.2	49.2	102.2	100	2.2	12	1
11.9	4	●	DWAE1190X04S120	49.8	79.2	81.2	123.2	121	2.2	12	1
12.0	2	●	DWAE1200X02S120	26.2	47.2	49.2	102.2	100	2.2	12	1
12.0	4	●	DWAE1200X04S120	50.2	79.2	81.2	123.2	121	2.2	12	1
12.1	2	●	DWAE1210X02S130	26.4	49.2	51.2	102.2	100	2.2	13	1
12.1	4	●	DWAE1210X04S130	50.6	82.2	84.2	139.2	137	2.2	13	1
12.2	2	●	DWAE1220X02S130	26.6	49.2	51.2	102.2	100	2.2	13	1
12.2	4	●	DWAE1220X04S130	51.0	82.2	84.2	139.2	137	2.2	13	1
12.3	2	●	DWAE1230X02S130	26.8	49.2	51.2	102.2	100	2.2	13	1
12.3	4	●	DWAE1230X04S130	51.4	82.2	84.2	139.2	137	2.2	13	1
12.4	2	●	DWAE1240X02S130	27.1	49.3	51.3	102.3	100	2.3	13	1
12.4	4	●	DWAE1240X04S130	51.9	82.3	84.3	139.3	137	2.3	13	1
12.5	2	●	DWAE1250X02S130	27.3	49.3	51.3	102.3	100	2.3	13	1
12.5	4	●	DWAE1250X04S130	52.3	82.3	84.3	139.3	137	2.3	13	1
12.6	2	●	DWAE1260X02S130	27.5	52.3	54.3	102.3	100	2.3	13	1
12.6	4	●	DWAE1260X04S130	52.7	84.3	86.3	139.3	137	2.3	13	1
12.7	2	●	DWAE1270X02S130	27.7	52.3	54.3	102.3	100	2.3	13	1
12.7	4	●	DWAE1270X04S130	53.1	84.3	86.3	139.3	137	2.3	13	1
12.8	2	●	DWAE1280X02S130	27.9	52.3	54.3	102.3	100	2.3	13	1
12.8	4	●	DWAE1280X04S130	53.5	84.3	86.3	139.3	137	2.3	13	1
12.9	2	●	DWAE1290X02S130	28.1	52.3	54.3	102.3	100	2.3	13	1
12.9	4	●	DWAE1290X04S130	53.9	84.3	86.3	139.3	137	2.3	13	1

M

BOHREN

# DWAE

M  
BOHREN

DC (mm)	Bohr- tiefe (L/D)	DP102A	Bestellnummer	Abmessungen (mm)							Typ
				LU	LCF	LH	OAL	LF	PL	DCONMS	
13.0	2	●	DWAE1300X02S130	28.4	52.4	54.4	102.4	100	2.4	13	1
13.0	4	●	DWAE1300X04S130	54.4	84.4	86.4	139.4	137	2.4	13	1
13.1	2	●	DWAE1310X02S140	28.6	55.4	57.4	102.4	100	2.4	14	1
13.1	4	●	DWAE1310X04S140	54.8	92.4	94.4	149.4	147	2.4	14	1
13.2	2	●	DWAE1320X02S140	28.8	55.4	57.4	102.4	100	2.4	14	1
13.2	4	●	DWAE1320X04S140	55.2	92.4	94.4	149.4	147	2.4	14	1
13.3	2	●	DWAE1330X02S140	29.0	55.4	57.4	102.4	100	2.4	14	1
13.3	4	●	DWAE1330X04S140	55.6	92.4	94.4	149.4	147	2.4	14	1
13.4	2	●	DWAE1340X02S140	29.2	55.4	57.4	102.4	100	2.4	14	1
13.4	4	●	DWAE1340X04S140	56.0	92.4	94.4	149.4	147	2.4	14	1
13.5	2	●	DWAE1350X02S140	29.5	55.5	57.5	102.5	100	2.5	14	1
13.5	4	●	DWAE1350X04S140	56.5	92.5	94.5	149.5	147	2.5	14	1
13.6	2	●	DWAE1360X02S140	29.7	57.5	59.5	102.5	100	2.5	14	1
13.6	4	●	DWAE1360X04S140	56.9	97.5	99.5	149.5	147	2.5	14	1
13.7	2	●	DWAE1370X02S140	29.9	57.5	59.5	102.5	100	2.5	14	1
13.7	4	●	DWAE1370X04S140	57.3	97.5	99.5	149.5	147	2.5	14	1
13.8	2	●	DWAE1380X02S140	30.1	57.5	59.5	102.5	100	2.5	14	1
13.8	4	●	DWAE1380X04S140	57.7	97.5	99.5	149.5	147	2.5	14	1
13.9	2	●	DWAE1390X02S140	30.3	57.5	59.5	102.5	100	2.5	14	1
13.9	4	●	DWAE1390X04S140	58.1	97.5	99.5	149.5	147	2.5	14	1
14.0	2	●	DWAE1400X02S140	30.5	57.5	59.5	102.5	100	2.5	14	1
14.0	4	●	DWAE1400X04S140	58.5	97.5	99.5	149.5	147	2.5	14	1

● : Lagerstandard.

# SCHNITTDATENEMPFEHLUNGEN

Material	P							
	Baustahl ( $\leq 180\text{HB}$ ) EU S275JR, Ck10 etc.				C-Stahl, legierter Stahl (180–250HB) C45, 42CrMo4 etc.			
Bohrer- Durchm. DC (mm)	Schnittgeschw. (m/min)	Drehzahl (min <sup>-1</sup> )	Vorschub (min.–max.) (mm/U.)	Tischvorschub (mm/min)	Schnittgeschw. (m/min)	Drehzahl (min <sup>-1</sup> )	Vorschub (min.–max.) (mm/U.)	Tischvorschub (mm/min)
<b>1.0</b>	30	9500	0.03 (0.02–0.04)	285	30	9500	0.03 (0.02–0.04)	285
<b>1.5</b>	30	6300	0.05 (0.03–0.06)	315	30	6300	0.05 (0.03–0.06)	315
<b>2.0</b>	55	8700	0.06 (0.04–0.08)	520	55	8700	0.06 (0.04–0.08)	520
<b>2.5</b>	55	7000	0.08 (0.05–0.10)	560	55	7000	0.08 (0.05–0.10)	560
<b>3.0</b>	65	6800	0.09 (0.07–0.11)	610	60	6300	0.09 (0.07–0.11)	565
<b>4.0</b>	70	5500	0.12 (0.09–0.14)	660	65	5100	0.12 (0.09–0.14)	610
<b>5.0</b>	70	4400	0.15 (0.11–0.18)	660	65	4100	0.15 (0.11–0.18)	615
<b>6.0</b>	80	4200	0.18 (0.14–0.21)	755	75	3900	0.18 (0.14–0.21)	700
<b>7.0</b>	80	3600	0.21 (0.16–0.25)	755	75	3400	0.21 (0.16–0.25)	715
<b>8.0</b>	85	3300	0.23 (0.18–0.28)	760	80	3100	0.23 (0.18–0.28)	715
<b>10.0</b>	90	2800	0.27 (0.21–0.32)	755	85	2700	0.27 (0.21–0.32)	730
<b>12.0</b>	95	2500	0.28 (0.22–0.34)	700	90	2300	0.28 (0.22–0.34)	645
<b>14.0</b>	95	2100	0.29 (0.23–0.35)	610	90	2000	0.29 (0.23–0.35)	580

Material	P				M			
	C-Stahl, legierter Stahl (280–350HB) 40CrNiMo etc.				Austenitischer rostfreier Stahl ( $\leq 200\text{HB}$ ) Ferritischer und martensitischer rostfreier Stahl ( $> 200\text{HB}$ ) X12CrS13, X30Cr13 etc.			
Bohrer- Durchm. DC (mm)	Schnittgeschw. (m/min)	Drehzahl (min <sup>-1</sup> )	Vorschub (min.–max.) (mm/U.)	Tischvorschub (mm/min)	Schnittgeschw. (m/min)	Drehzahl (min <sup>-1</sup> )	Vorschub (min.–max.) (mm/U.)	Tischvorschub (mm/min)
<b>1.0</b>	25	7900	0.02 (0.01–0.03)	160	30	9500	0.02 (0.01–0.03)	190
<b>1.5</b>	25	5300	0.04 (0.02–0.05)	210	30	6300	0.04 (0.02–0.05)	250
<b>2.0</b>	50	7900	0.05 (0.03–0.07)	395	35	5500	0.04 (0.02–0.06)	220
<b>2.5</b>	50	6300	0.07 (0.04–0.09)	440	35	4400	0.06 (0.03–0.08)	265
<b>3.0</b>	55	5800	0.08 (0.06–0.09)	465	40	4200	0.07 (0.04–0.10)	295
<b>4.0</b>	60	4700	0.11 (0.08–0.13)	515	40	3100	0.08 (0.05–0.10)	250
<b>5.0</b>	60	3800	0.13 (0.10–0.16)	495	40	2500	0.10 (0.05–0.15)	250
<b>6.0</b>	70	3700	0.16 (0.12–0.19)	590	40	2100	0.11 (0.06–0.15)	230
<b>7.0</b>	70	3100	0.18 (0.14–0.22)	560	40	1800	0.12 (0.06–0.18)	215
<b>8.0</b>	75	2900	0.21 (0.16–0.25)	610	40	1500	0.13 (0.06–0.20)	195
<b>10.0</b>	80	2500	0.24 (0.20–0.28)	600	40	1200	0.14 (0.08–0.20)	170
<b>12.0</b>	85	2200	0.25 (0.20–0.30)	550	40	1000	0.18 (0.10–0.25)	180
<b>14.0</b>	85	1900	0.25 (0.20–0.30)	475	40	900	0.18 (0.10–0.25)	160

Hinweis 1) Die oben angegebenen Schnittdaten beziehen sich auf die Verwendung mit wasserlöslichem Kühlmittel. Für die Bearbeitung rostfreier Stähle wird nicht wasserlösliches Kühlmittel empfohlen.

Hinweis 2) Bei Verwendung eines nicht wasserlöslichen Kühlmittels empfehlen wir die Drehzahl um 20 % zu reduzieren, um eine angemessene Schmierung zu erzielen.

Hinweis 3) Prüfen Sie den Zustand der Späne und bohren Sie ggfs. mit kurzen Unterbrechungen. \* Referenz für Unterbrechungen: 0.2 bis 1.0 DC

Hinweis 4) Passen Sie die Schnittbedingungen dem Werkzeug, der Stabilität der Werkstückspannvorrichtung und der Bearbeitungsstrategie etc. an.

Hinweis 5) Bearbeitungstiefen, die größer als die Nutenlänge (LU) sind, werden nicht empfohlen.

Hinweis 6) Spannen Sie den Bohrer so ein, dass der Rundlauffehler des Bohrers nicht mehr als 0.03 mm beträgt.

Hinweis 7) Spannen Sie den Bohrer nicht an der Spannut.

M

BOHREN

# BOHREN (VOLLHARTMETALL)

HARTMETALL

## SCHNITTDATENEMPFEHLUNGEN

Bohrer-Durchm. DC (mm)	K							
	Grauguss ( $\leq 350\text{MPa}$ )				Duktiles Gusseisen ( $\leq 450\text{MPa}$ )			
	Schnittgeschw. (m/min)	Drehzahl ( $\text{min}^{-1}$ )	Vorschub (min. – max.) (mm/U.)	Tischvorschub (mm/min)	Schnittgeschw. (m/min)	Drehzahl ( $\text{min}^{-1}$ )	Vorschub (min. – max.) (mm/U.)	Tischvorschub (mm/min)
<b>1.0</b>	30	9500	0.03 (0.02–0.04)	285	25	7900	0.02 (0.01–0.03)	160
<b>1.5</b>	30	6300	0.05 (0.03–0.06)	315	25	5300	0.04 (0.02–0.05)	210
<b>2.0</b>	55	8700	0.06 (0.04–0.08)	520	50	7900	0.05 (0.03–0.07)	395
<b>2.5</b>	55	7000	0.08 (0.05–0.10)	560	50	6300	0.07 (0.04–0.09)	440
<b>3.0</b>	65	6800	0.09 (0.07–0.11)	610	55	5800	0.09 (0.05–0.12)	520
<b>4.0</b>	70	5500	0.12 (0.09–0.14)	660	60	4700	0.12 (0.07–0.17)	565
<b>5.0</b>	70	4400	0.15 (0.11–0.18)	660	60	3800	0.14 (0.08–0.20)	530
<b>6.0</b>	80	4200	0.18 (0.14–0.21)	755	70	3700	0.15 (0.10–0.20)	555
<b>7.0</b>	80	3600	0.21 (0.16–0.25)	755	70	3100	0.18 (0.12–0.23)	560
<b>8.0</b>	85	3300	0.23 (0.18–0.28)	760	75	2900	0.20 (0.15–0.25)	580
<b>10.0</b>	90	2800	0.27 (0.21–0.32)	755	80	2500	0.23 (0.18–0.28)	575
<b>12.0</b>	95	2500	0.28 (0.22–0.34)	700	85	2200	0.25 (0.20–0.30)	550
<b>14.0</b>	95	2100	0.29 (0.23–0.35)	610	85	1900	0.25 (0.20–0.30)	475

Hinweis 1) Die oben angegebenen Schnittdaten beziehen sich auf die Verwendung mit wasserlöslichem Kühlmittel. Für die Bearbeitung rostfreier Stähle wird nicht wasserlösliches Kühlmittel empfohlen.

Hinweis 2) Bei Verwendung eines nicht wasserlöslichen Kühlmittels empfehlen wir die Drehzahl um 20 % zu reduzieren, um eine angemessene Schmierung zu erzielen.

Hinweis 3) Prüfen Sie den Zustand der Späne und bohren Sie ggfs. mit kurzen Unterbrechungen. \* Referenz für Unterbrechungen: 0.2 bis 1.0 DC

Hinweis 4) Passen Sie die Schnittbedingungen dem Werkzeug, der Stabilität der Werkstückspannvorrichtung und der Bearbeitungsstrategie etc. an.

Hinweis 5) Bearbeitungstiefen, die größer als die Nutenlänge (LU) sind, werden nicht empfohlen.

Hinweis 6) Spannen Sie den Bohrer so ein, dass der Rundlauffehler des Bohrers nicht mehr als 0.03 mm beträgt.

Hinweis 7) Spannen Sie den Bohrer nicht an der Spannnut.

M

BOHREN



Interne Kühlung

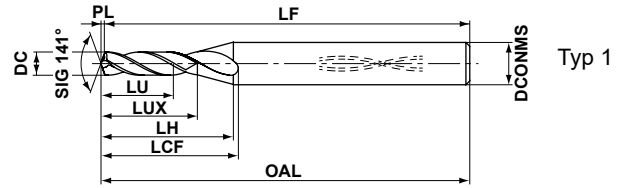

	DC<3
	0.006 -0.004
	DCONMS=4
	0 -0.008

DC (mm)	Bohrtiefe (L/D)	DP1120	Bestellnummer	Abmessungen (mm)								Typ
				LU	LUX	LCF	LH	OAL	LF	PL	DCONMS	
1.0	2	●	DVAS0100X02S040	2.2	3.2	8.6	8.8	50.0	49.8	0.2	4	1
1.1	2	●	DVAS0110X02S040	2.4	3.5	9.0	8.9	50.0	49.8	0.2	4	1
1.2	2	●	DVAS0120X02S040	2.6	3.9	9.4	9.0	50.0	49.8	0.2	4	1
1.3	2	●	DVAS0130X02S040	2.8	4.2	9.9	9.2	50.0	49.8	0.2	4	1
1.4	2	●	DVAS0140X02S040	3.0	4.5	10.3	9.3	50.0	49.8	0.2	4	1
1.5	2	●	DVAS0150X02S040	3.3	4.8	10.7	9.4	50.0	49.7	0.3	4	1
1.6	2	●	DVAS0160X02S040	3.5	5.1	11.1	9.6	50.0	49.7	0.3	4	1
1.7	2	●	DVAS0170X02S040	3.7	5.5	11.6	9.7	50.0	49.7	0.3	4	1
1.8	2	●	DVAS0180X02S040	3.9	5.8	12.0	9.8	50.0	49.7	0.3	4	1
1.9	2	●	DVAS0190X02S040	4.1	6.1	12.4	10.0	50.0	49.7	0.3	4	1
2.0	2	●	DVAS0200X02S040	4.4	6.4	12.9	10.1	50.0	49.6	0.4	4	1
2.1	2	●	DVAS0210X02S040	4.6	6.7	13.3	10.2	50.0	49.6	0.4	4	1
2.2	2	●	DVAS0220X02S040	4.8	7.0	13.7	10.3	50.0	49.6	0.4	4	1
2.3	2	●	DVAS0230X02S040	5.0	7.4	14.1	10.5	55.0	54.6	0.4	4	1
2.4	2	●	DVAS0240X02S040	5.2	7.7	14.6	10.6	55.0	54.6	0.4	4	1
2.5	2	●	DVAS0250X02S040	5.5	8.0	15.0	10.7	55.0	54.6	0.4	4	1
2.6	2	●	DVAS0260X02S040	5.7	8.3	15.4	10.9	55.0	54.5	0.5	4	1
2.7	2	●	DVAS0270X02S040	5.9	8.6	15.8	11.0	55.0	54.5	0.5	4	1
2.8	2	●	DVAS0280X02S040	6.1	8.9	16.3	11.1	55.0	54.5	0.5	4	1
2.9	2	●	DVAS0290X02S040	6.3	9.3	16.7	11.3	55.0	54.5	0.5	4	1

● : Lagerstandard.

SCHNITTBEDINGUNGEN > M037  
ANWENDUNGSHINWEISE > M038  
TECHNISCHE DATEN > P001

M033

BOHREN

M

# BOHREN (VOLLHARTMETALL)

**DVAS** Minibohrer  
TRISTAR-Bohrer

**NEW**



P M K N S H

Interne Kühlung

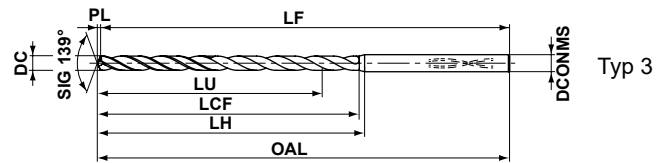
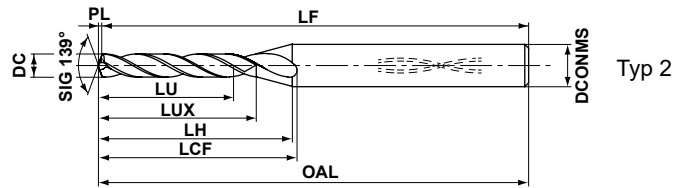

BOHREN

M

DC < 3
0 -0.010
DCONMS=4
0 -0.008

DC (mm)	Bohrtiefe (L/D)	DP1120	Bestellnummer	Abmessungen (mm)								Typ
				LU	LUX	LCF	LH	OAL	LF	PL	DCONMS	
1.0	7	●	DVAS0100X07S040	7.2	8.2	13.6	13.8	55.0	54.8	0.2	4	2
1.0	12	●	DVAS0100X12S040	12.2	13.2	18.6	18.8	58.0	57.8	0.2	4	2
1.0	20	●	DVAS0100X20S040	20.2	-	23.2	28.8	67.0	66.8	0.2	4	3
1.0	25	●	DVAS0100X25S040	25.2	-	28.2	33.8	73.0	72.8	0.2	4	3
1.0	30	●	DVAS0100X30S040	30.2	-	33.2	38.8	79.0	78.8	0.2	4	3
1.0	40	●	DVAS0100X40S040	40.2	-	43.2	48.8	90.0	89.8	0.2	4	3
1.0	50	●	DVAS0100X50S040	50.2	-	53.2	58.8	102.0	101.8	0.2	4	3
1.1	7	●	DVAS0110X07S040	7.9	9.1	14.5	14.4	55.0	54.8	0.2	4	2
1.1	12	●	DVAS0110X12S040	13.4	14.6	20.0	19.9	58.0	57.8	0.2	4	2
1.1	20	●	DVAS0110X20S040	22.2	-	25.5	30.9	67.0	66.8	0.2	4	3
1.1	25	●	DVAS0110X25S040	27.7	-	31.0	36.4	73.0	72.8	0.2	4	3
1.1	30	●	DVAS0110X30S040	33.2	-	36.5	41.9	79.0	78.8	0.2	4	3
1.1	40	●	DVAS0110X40S040	44.2	-	47.5	52.9	90.0	89.8	0.2	4	3
1.2	7	●	DVAS0120X07S040	8.6	9.9	15.4	15.0	55.0	54.8	0.2	4	2
1.2	12	●	DVAS0120X12S040	14.6	15.9	21.4	21.0	60.0	59.8	0.2	4	2
1.2	20	●	DVAS0120X20S040	24.2	-	27.8	33.0	71.0	70.8	0.2	4	3
1.2	25	●	DVAS0120X25S040	30.2	-	33.8	39.0	77.0	76.8	0.2	4	3
1.2	30	●	DVAS0120X30S040	36.2	-	39.8	45.0	84.0	83.8	0.2	4	3
1.2	40	●	DVAS0120X40S040	48.2	-	51.8	57.0	97.0	96.8	0.2	4	3
1.3	7	●	DVAS0130X07S040	9.3	10.7	16.4	15.7	55.0	54.8	0.2	4	2
1.3	12	●	DVAS0130X12S040	15.8	17.2	22.9	22.2	60.0	59.8	0.2	4	2
1.3	20	●	DVAS0130X20S040	26.2	-	30.1	35.2	71.0	70.8	0.2	4	3
1.3	25	●	DVAS0130X25S040	32.7	-	36.6	41.7	77.0	76.8	0.2	4	3
1.3	30	●	DVAS0130X30S040	39.2	-	43.1	48.2	84.0	83.8	0.2	4	3
1.3	40	●	DVAS0130X40S040	52.2	-	56.1	61.2	97.0	96.8	0.2	4	3
1.4	7	●	DVAS0140X07S040	10.1	11.5	17.3	16.3	55.0	54.7	0.3	4	2
1.4	12	●	DVAS0140X12S040	17.1	18.5	24.3	23.3	63.0	62.7	0.3	4	2
1.4	20	●	DVAS0140X20S040	28.3	-	32.5	37.3	75.0	74.7	0.3	4	3
1.4	25	●	DVAS0140X25S040	35.3	-	39.5	44.3	82.0	81.7	0.3	4	3
1.4	30	●	DVAS0140X30S040	42.3	-	46.5	51.3	90.0	89.7	0.3	4	3
1.4	40	●	DVAS0140X40S040	56.3	-	60.5	65.3	105.0	104.7	0.3	4	3
1.5	7	●	DVAS0150X07S040	10.8	12.3	18.2	16.9	55.0	54.7	0.3	4	2
1.5	12	●	DVAS0150X12S040	18.3	19.8	25.7	24.4	63.0	62.7	0.3	4	2
1.5	20	●	DVAS0150X20S040	30.3	-	34.8	39.4	75.0	74.7	0.3	4	3
1.5	25	●	DVAS0150X25S040	37.8	-	42.3	46.9	82.0	81.7	0.3	4	3
1.5	30	●	DVAS0150X30S040	45.3	-	49.8	54.4	90.0	89.7	0.3	4	3

● : Lagerstandard.



DC (mm)	Bohrtiefe (L/D)	DP1120	Bestellnummer	Abmessungen (mm)								Typ
				LU	LUX	LCF	LH	OAL	LF	PL	DCONMS	
1.5	40	●	DVAS0150X40S040	60.3	–	64.8	69.4	105.0	104.7	0.3	4	3
1.5	50	●	DVAS0150X50S040	75.3	–	79.8	84.4	120.0	119.7	0.3	4	3
1.6	7	●	DVAS0160X07S040	11.5	13.1	19.2	17.6	57.0	56.7	0.3	4	2
1.6	12	●	DVAS0160X12S040	19.5	21.1	27.2	25.6	66.0	65.7	0.3	4	2
1.6	20	●	DVAS0160X20S040	32.3	–	37.1	41.6	79.0	78.7	0.3	4	3
1.6	25	●	DVAS0160X25S040	40.3	–	45.1	49.6	88.0	87.7	0.3	4	3
1.6	30	●	DVAS0160X30S040	48.3	–	53.1	57.6	99.0	98.7	0.3	4	3
1.6	40	●	DVAS0160X40S040	64.3	–	69.1	73.6	113.0	112.7	0.3	4	3
1.7	7	●	DVAS0170X07S040	12.2	14.0	20.1	18.2	57.0	56.7	0.3	4	2
1.7	12	●	DVAS0170X12S040	20.7	22.5	28.6	26.7	66.0	65.7	0.3	4	2
1.7	20	●	DVAS0170X20S040	34.3	–	39.4	43.7	79.0	78.7	0.3	4	3
1.7	25	●	DVAS0170X25S040	42.8	–	47.9	52.2	88.0	87.7	0.3	4	3
1.7	30	●	DVAS0170X30S040	51.3	–	56.4	60.7	99.0	98.7	0.3	4	3
1.7	40	●	DVAS0170X40S040	68.3	–	73.4	77.7	113.0	112.7	0.3	4	3
1.8	7	●	DVAS0180X07S040	12.9	14.8	21.0	18.8	59.0	58.7	0.3	4	2
1.8	12	●	DVAS0180X12S040	21.9	23.8	30.0	27.8	69.0	68.7	0.3	4	2
1.8	20	●	DVAS0180X20S040	36.3	–	41.7	45.8	84.0	83.7	0.3	4	3
1.8	25	●	DVAS0180X25S040	45.3	–	50.7	54.8	94.0	93.7	0.3	4	3
1.8	30	●	DVAS0180X30S040	54.3	–	59.7	63.8	104.0	103.7	0.3	4	3
1.8	40	●	DVAS0180X40S040	72.3	–	77.7	81.8	123.0	122.7	0.3	4	3
1.9	7	●	DVAS0190X07S040	13.7	15.6	21.9	19.5	59.0	58.6	0.4	4	2
1.9	12	●	DVAS0190X12S040	23.2	25.1	31.4	29.0	69.0	68.6	0.4	4	2
1.9	20	●	DVAS0190X20S040	38.4	–	44.1	48.0	84.0	83.6	0.4	4	3
1.9	25	●	DVAS0190X25S040	47.9	–	53.6	57.5	94.0	93.6	0.4	4	3
1.9	30	●	DVAS0190X30S040	57.4	–	63.1	67.0	104.0	103.6	0.4	4	3
1.9	40	●	DVAS0190X40S040	76.4	–	82.1	86.0	123.0	122.6	0.4	4	3
2.0	7	●	DVAS0200X07S040	14.4	16.4	22.9	20.1	62.0	61.6	0.4	4	2
2.0	12	●	DVAS0200X12S040	24.4	26.4	32.9	30.1	73.0	72.6	0.4	4	2
2.0	20	●	DVAS0200X20S040	40.4	–	46.4	50.1	91.0	90.6	0.4	4	3
2.0	25	●	DVAS0200X25S040	50.4	–	56.4	60.1	102.0	101.6	0.4	4	3
2.0	30	●	DVAS0200X30S040	60.4	–	66.4	70.1	113.0	112.6	0.4	4	3
2.0	40	●	DVAS0200X40S040	80.4	–	86.4	90.1	136.0	135.6	0.4	4	3
2.0	50	●	DVAS0200X50S040	100.4	–	106.4	110.1	158.0	157.6	0.4	4	3
2.1	7	●	DVAS0210X07S040	15.1	17.2	23.8	20.7	62.0	61.6	0.4	4	2
2.1	12	●	DVAS0210X12S040	25.6	27.7	34.3	31.2	73.0	72.6	0.4	4	2
2.1	20	●	DVAS0210X20S040	42.4	–	48.7	52.2	91.0	90.6	0.4	4	3
2.1	25	●	DVAS0210X25S040	52.9	–	59.2	62.7	102.0	101.6	0.4	4	3
2.1	30	●	DVAS0210X30S040	63.4	–	69.7	73.2	113.0	112.6	0.4	4	3
2.1	40	●	DVAS0210X40S040	84.4	–	90.7	94.2	136.0	135.6	0.4	4	3
2.2	7	●	DVAS0220X07S040	15.8	18.1	24.7	21.4	62.0	61.6	0.4	4	2
2.2	12	●	DVAS0220X12S040	26.8	29.1	35.7	32.4	73.0	72.6	0.4	4	2
2.2	20	●	DVAS0220X20S040	44.4	–	51.0	54.4	91.0	90.6	0.4	4	3
2.2	25	●	DVAS0220X25S040	55.4	–	62.0	65.4	102.0	101.6	0.4	4	3
2.2	30	●	DVAS0220X30S040	66.4	–	73.0	76.4	113.0	112.6	0.4	4	3
2.2	40	●	DVAS0220X40S040	88.4	–	95.0	98.4	136.0	135.6	0.4	4	3
2.3	7	●	DVAS0230X07S040	16.5	18.9	25.7	22.0	65.0	64.6	0.4	4	2
2.3	12	●	DVAS0230X12S040	28.0	30.4	37.2	33.5	78.0	77.6	0.4	4	2
2.3	20	●	DVAS0230X20S040	46.4	–	53.3	56.5	98.0	97.6	0.4	4	3

M

BOHREN

# BOHREN (VOLLHARTMETALL)

**DVAS** Minibohrer **NEW**  
TRISTAR-Bohrer

HARTMETALL

M  
BOHREN

DC (mm)	Bohrtiefe (L/D)	DP1120	Bestellnummer	Abmessungen (mm)								Typ
				LU	LUX	LCF	LH	OAL	LF	PL	DCONMS	
2.3	25	●	DVAS0230X25S040	57.9	–	64.8	68.0	111.0	110.6	0.4	4	3
2.3	30	●	DVAS0230X30S040	69.4	–	76.3	79.5	124.0	123.6	0.4	4	3
2.3	40	●	DVAS0230X40S040	92.4	–	99.3	102.5	150.0	149.6	0.4	4	3
2.4	7	●	DVAS0240X07S040	17.2	19.7	26.6	22.6	65.0	64.6	0.4	4	2
2.4	12	●	DVAS0240X12S040	29.2	31.7	38.6	34.6	78.0	77.6	0.4	4	2
2.4	20	●	DVAS0240X20S040	48.4	–	55.6	58.6	98.0	97.6	0.4	4	3
2.4	25	●	DVAS0240X25S040	60.4	–	67.6	70.6	111.0	110.6	0.4	4	3
2.4	30	●	DVAS0240X30S040	72.4	–	79.6	82.6	124.0	123.6	0.4	4	3
2.4	40	●	DVAS0240X40S040	96.4	–	103.6	106.6	150.0	149.6	0.4	4	3
2.5	7	●	DVAS0250X07S040	18.0	20.5	27.5	23.3	65.0	64.5	0.5	4	2
2.5	12	●	DVAS0250X12S040	30.5	33.0	40.0	35.8	78.0	77.5	0.5	4	2
2.5	20	●	DVAS0250X20S040	50.5	–	58.0	60.8	98.0	97.5	0.5	4	3
2.5	25	●	DVAS0250X25S040	63.0	–	70.5	73.3	111.0	110.5	0.5	4	3
2.5	30	●	DVAS0250X30S040	75.5	–	83.0	85.8	124.0	123.5	0.5	4	3
2.5	40	●	DVAS0250X40S040	100.5	–	108.0	110.8	150.0	149.5	0.5	4	3
2.5	50	●	DVAS0250X50S040	125.5	–	133.0	135.8	176.0	175.5	0.5	4	3
2.6	7	●	DVAS0260X07S040	18.7	21.3	28.4	23.9	65.0	64.5	0.5	4	2
2.6	12	●	DVAS0260X12S040	31.7	34.3	41.4	36.9	78.0	77.5	0.5	4	2
2.6	20	●	DVAS0260X20S040	52.5	–	60.3	62.9	98.0	97.5	0.5	4	3
2.6	25	●	DVAS0260X25S040	65.5	–	73.3	75.9	111.0	110.5	0.5	4	3
2.6	30	●	DVAS0260X30S040	78.5	–	86.3	88.9	124.0	123.5	0.5	4	3
2.6	40	●	DVAS0260X40S040	104.5	–	112.3	114.9	150.0	149.5	0.5	4	3
2.7	7	●	DVAS0270X07S040	19.4	22.2	29.4	24.5	68.0	67.5	0.5	4	2
2.7	12	●	DVAS0270X12S040	32.9	35.7	42.9	38.0	83.0	82.5	0.5	4	2
2.7	20	●	DVAS0270X20S040	54.5	–	62.6	65.0	107.0	106.5	0.5	4	3
2.7	25	●	DVAS0270X25S040	68.0	–	76.1	78.5	122.0	121.5	0.5	4	3
2.7	30	●	DVAS0270X30S040	81.5	–	89.6	92.0	137.0	136.5	0.5	4	3
2.7	40	●	DVAS0270X40S040	108.5	–	116.6	119.0	167.0	166.5	0.5	4	3
2.8	7	●	DVAS0280X07S040	20.1	23.0	30.3	25.2	68.0	67.5	0.5	4	2
2.8	12	●	DVAS0280X12S040	34.1	37.0	44.3	39.2	83.0	82.5	0.5	4	2
2.8	20	●	DVAS0280X20S040	56.5	–	64.9	67.2	107.0	106.5	0.5	4	3
2.8	25	●	DVAS0280X25S040	70.5	–	78.9	81.2	122.0	121.5	0.5	4	3
2.8	30	●	DVAS0280X30S040	84.5	–	92.9	95.2	137.0	136.5	0.5	4	3
2.8	40	●	DVAS0280X40S040	112.5	–	120.9	123.2	167.0	166.5	0.5	4	3
2.9	7	●	DVAS0290X07S040	20.8	23.8	31.2	25.8	68.0	67.5	0.5	4	2
2.9	12	●	DVAS0290X12S040	35.3	38.3	45.7	40.3	83.0	82.5	0.5	4	2
2.9	20	●	DVAS0290X20S040	58.5	–	67.2	69.3	107.0	106.5	0.5	4	3
2.9	25	●	DVAS0290X25S040	73.0	–	81.7	83.8	122.0	121.5	0.5	4	3
2.9	30	●	DVAS0290X30S040	87.5	–	96.2	98.3	137.0	136.5	0.5	4	3
2.9	40	●	DVAS0290X40S040	116.5	–	125.2	127.3	167.0	166.5	0.5	4	3

● : Lagerstandard.

## SCHNITTDATENEMPFEHLUNGEN

Material		P			M		
Allg. Baustahl C-Stahl, Leg. Stahl		Rostfreier Stahl (austenitisch), Ferritisch rostfreier Stahl Rostfreie Stähle, ferritisch und martensitisch Ausscheidungshärtung von rostfreiem Stahl			X12 Cr 13, X30 Cr 13, X5CrNi18-10, X5CrNiMo17-12-2, 1 7-4PH etc		
St44-2, C10, CK45, 41CrMo4 etc							
Bohrer Durchm. DC (mm)	L/D	Schnittgeschw. (min.-max.) (m/min)	Drehzahl (min <sup>-1</sup> )	Vorschub (min.-max.) (mm/U.)	Schnittgeschw. (min.-max.) (m/min)	Drehzahl (min <sup>-1</sup> )	Vorschub (min.-max.) (mm/U.)
1.0	2-30	65 (30-100)	20700	0.035 (0.020-0.050)	60 (20-100)	19100	0.025 (0.010-0.040)
1.0	40, 50	65 (30-100)	20700	0.030 (0.020-0.040)	60 (20-100)	19100	0.020 (0.010-0.030)
1.5	2-30	65 (30-100)	13800	0.053 (0.030-0.075)	60 (20-100)	12700	0.038 (0.015-0.060)
1.5	40, 50	65 (30-100)	13800	0.045 (0.030-0.060)	60 (20-100)	12700	0.030 (0.015-0.045)
2.0	2-30	70 (40-100)	11100	0.070 (0.040-0.100)	60 (20-100)	9500	0.050 (0.020-0.080)
2.0	40, 50	70 (40-100)	11100	0.060 (0.040-0.080)	60 (20-100)	9500	0.040 (0.020-0.060)
2.5	2-30	70 (40-100)	8900	0.088 (0.050-0.125)	60 (20-100)	7600	0.063 (0.025-0.100)
2.5	40, 50	70 (40-100)	8900	0.075 (0.050-0.100)	60 (20-100)	7600	0.050 (0.025-0.075)
2.9	2-30	70 (40-100)	7700	0.102 (0.058-0.145)	60 (20-100)	6600	0.073 (0.029-0.116)
2.9	40, 50	70 (40-100)	7700	0.087 (0.058-0.116)	60 (20-100)	6600	0.058 (0.029-0.087)

Material		K			N		
Grauguss Duktiler Guss		Aluminiumleg.			AlMg2(B), AlMg1SiCu, Al-Zn6MgCu		
GG-30, GGG-40 etc							
Bohrer Durchm. DC (mm)	L/D	Schnittgeschw. (min.-max.) (m/min)	Drehzahl (min <sup>-1</sup> )	Vorschub (min.-max.) (mm/U.)	Schnittgeschw. (min.-max.) (m/min)	Drehzahl (min <sup>-1</sup> )	Vorschub (min.-max.) (mm/U.)
1.0	2-30	70 (40-100)	22300	0.035 (0.020-0.050)	140 (100-180)	31800	0.040 (0.020-0.060)
1.0	40, 50	70 (40-100)	22300	0.030 (0.020-0.040)	140 (100-180)	31800	0.035 (0.020-0.050)
1.5	2-30	70 (40-100)	14900	0.053 (0.030-0.075)	140 (100-180)	21200	0.060 (0.030-0.090)
1.5	40, 50	70 (40-100)	14900	0.045 (0.030-0.060)	140 (100-180)	21200	0.053 (0.030-0.075)
2.0	2-30	70 (40-100)	11100	0.070 (0.040-0.100)	140 (100-180)	15900	0.080 (0.040-0.120)
2.0	40, 50	70 (40-100)	11100	0.060 (0.040-0.080)	140 (100-180)	15900	0.070 (0.040-0.100)
2.5	2-30	70 (40-100)	8900	0.088 (0.050-0.125)	140 (100-180)	12700	0.100 (0.050-0.150)
2.5	40, 50	70 (40-100)	8900	0.075 (0.050-0.100)	140 (100-180)	12700	0.088 (0.050-0.125)
2.9	2-30	70 (40-100)	7700	0.102 (0.058-0.145)	140 (100-180)	11000	0.116 (0.058-0.174)
2.9	40, 50	70 (40-100)	7700	0.087 (0.058-0.116)	140 (100-180)	11000	0.102 (0.058-0.145)

Material		S					
Hitzebeständige Legierung		Titanlegierung			Titanlegierung		
Inconel® 718 etc		Ti-6Al-4V etc					
Bohrer Durchm. DC (mm)	L/D	Schnittgeschw. (min.-max.) (m/min)	Drehzahl (min <sup>-1</sup> )	Vorschub (min.-max.) (mm/U.)	Schnittgeschw. (min.-max.) (m/min)	Drehzahl (min <sup>-1</sup> )	Vorschub (min.-max.) (mm/U.)
1.0	2-30	30 (10-50)	9500	0.015 (0.010-0.020)	30 (20-40)	9500	0.020 (0.010-0.030)
1.0	40, 50	30 (10-50)	9500	0.015 (0.010-0.020)	30 (20-40)	9500	0.020 (0.010-0.030)
1.5	2-30	30 (10-50)	6400	0.023 (0.015-0.030)	30 (20-40)	6400	0.030 (0.015-0.045)
1.5	40, 50	30 (10-50)	6400	0.023 (0.015-0.030)	30 (20-40)	6400	0.030 (0.015-0.045)
2.0	2-30	30 (10-50)	4800	0.030 (0.020-0.040)	30 (20-40)	4800	0.040 (0.020-0.060)
2.0	40, 50	30 (10-50)	4800	0.030 (0.020-0.040)	30 (20-40)	4800	0.040 (0.020-0.060)
2.5	2-30	30 (10-50)	3800	0.038 (0.025-0.050)	30 (20-40)	3800	0.050 (0.025-0.075)
2.5	40, 50	30 (10-50)	3800	0.038 (0.025-0.050)	30 (20-40)	3800	0.050 (0.025-0.075)
2.9	2-30	30 (10-50)	3300	0.044 (0.029-0.058)	30 (20-40)	3300	0.058 (0.029-0.087)
2.9	40, 50	30 (10-50)	3300	0.044 (0.029-0.058)	30 (20-40)	3300	0.058 (0.029-0.087)

Material		S		
Kobalt-Chrom-Legierungen				
T7402-2, CoCrMo, F799 etc				
Bohrer Durchm. DC (mm)	L/D	Schnittgeschw. (min.-max.) (m/min)	Drehzahl (min <sup>-1</sup> )	Vorschub (min.-max.) (mm/U.)
1.0	2-30	60 (30-90)	19100	0.020 (0.010-0.030)
1.0	40, 50	60 (30-90)	19100	0.020 (0.010-0.030)
1.5	2-30	60 (30-90)	12700	0.030 (0.015-0.045)
1.5	40, 50	60 (30-90)	12700	0.030 (0.015-0.045)
2.0	2-30	60 (30-90)	9500	0.040 (0.020-0.060)
2.0	40, 50	60 (30-90)	9500	0.040 (0.020-0.060)
2.5	2-30	60 (30-90)	7600	0.050 (0.025-0.075)
2.5	40, 50	60 (30-90)	7600	0.050 (0.025-0.075)
2.9	2-30	60 (30-90)	6600	0.058 (0.029-0.087)
2.9	40, 50	60 (30-90)	6600	0.058 (0.029-0.087)

Hinweis 1) Diese empfohlene Bedingung gilt nur bei Verwendung von internem Kühlmittel.

Hinweis 2) Prüfen Sie den Zustand der Späne und bohren Sie ggfs. mit kurzen Unterbrechungen. \* Referenz für Unterbrechungen: 0,2 bis 1,0 DC

Hinweis 3) Passen Sie die Schnittbedingungen dem Werkzeug, der Stabilität der Werkstückspannvorrichtung und der Bearbeitungsstrategie etc. an.

Hinweis 4) Bearbeitungstiefen, die größer als die Nutenlänge (LU) sind, werden nicht empfohlen.

Hinweis 5) Sicherstellen, dass der Rundlauffehler des Bohrers nicht mehr als 0,03 mm beträgt.

Hinweis 6) Spannen Sie den Bohrer nicht an der Spannt.

ANWENDUNGSHINWEISE > M038

TECHNISCHE DATEN > P001

M037

M

BOHREN

### EINSATZHINWEISE

#### ■ BEDIENHINWEISE FÜR DVAS L/D=2-40

### BOHREN AUF EINER EBENEN FLÄCHE

#### ■ 1. Pilotbohrung setzen

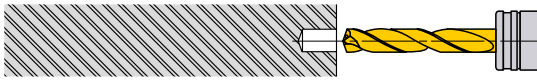

- ① Verwenden Sie einen Bohrer mit einem größeren (flacheren) Spitzenwinkel als die extralange Version. Verwenden Sie die kürzeste möglichen DVAS Bohrer. Ein DVAS-Bohrer mit L/D = 2 kann auf bis zu L/D = 3 bearbeitet werden, wenn Führungslöcher gebohrt werden.
- ② Sicherstellen, dass für die Führung ein hochpräzises Loch gebohrt wird.
- ③ Bohrtiefe: Ca. DC x 3.  
(Passen Sie die Tiefe der Pilotbohrung an die Länge des Tieflochbohrers an.)

#### ■ 2. Einfahren in die Pilotbohrung

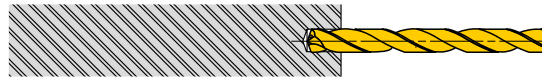

- ① Bohrer mit niedriger Drehzahl in die Pilotbohrung einfahren. (Drehzahl von 500 – 1000 min<sup>-1</sup>, Vorschub von 1000 – 2000 mm/min)
- ② Tieflochbohrer 0,5 – 1 mm vor dem Boden der Pilotbohrung stoppen.

#### ■ 3. Tieflochbohren

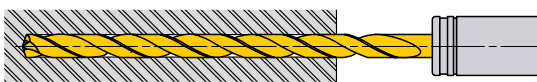

- ① Mit der empfohlenen Drehzahl und Vorschubrate in einem gleichmäßigen Zyklus (kontinuierlicher Vorschub) bis zur gewünschten Bohrungstiefe bohren (ohne zu lüften).

#### ■ 4. Herausfahren des Tieflochbohrers

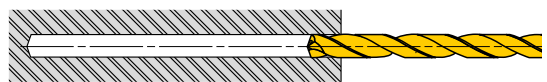

- ① Reduzieren Sie die nach Erreichen der Bohrtiefe die Drehzahl ca. 0,5 – 1 mm vor dem Bohrungsgrund. (Drehzahl von ca. 500 – 1000 min<sup>-1</sup>)
- ② Fahren Sie den Bohrer als nächstes bei einer Vorschubrate von 1000 – 2000 mm/min heraus.

### BOHREN AUF UNEBENEN FLÄCHEN

#### ■ 1. Anspiegeln

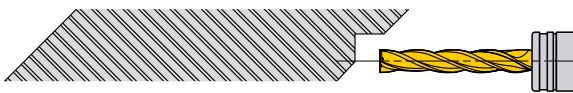

- ① Bearbeiten Sie die unebene Fläche mit einem geeigneten Schaftfräser oder Flachbohrer, der zum Anspiegeln geeignet ist. Der Durchmesser der Planfläche muss mindestens so groß wie der Durchmesser des Tieflochbohrers sein (auf Durchmessertoleranzen achten).

#### ■ 2. Pilotbohrung setzen



- ① Verwenden Sie einen Bohrer mit einem größeren (flacheren) Spitzenwinkel als die extralange Version. Verwenden Sie die kürzeste mögliche DVAS Bohrer
- ② Sicherstellen, dass für die Führung ein hochpräzises Loch gebohrt wird.
- ③ Bohrtiefe: Ca. DC x 2.  
(Passen Sie die Tiefe der Pilotbohrung an die Länge des Tieflochbohrers an.)

#### ■ 3. Einfahren in die Pilotbohrung

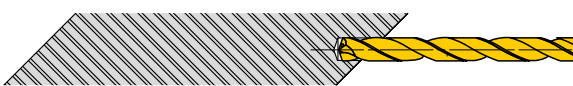

- ① Führen Sie den Bohrer bei einer niedrigen Drehzahl in die Pilotbohrung ein. (Spindeldrehzahl von 500 – 1000 min<sup>-1</sup>, Vorschubrate von 1000 – 2000 mm/min)
- ② Tieflochbohrer 0,5 – 1 mm vor dem Boden der Pilotbohrung stoppen.

#### ■ 4. Tieflochbohren

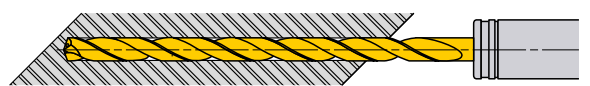

- ① Mit der empfohlenen Drehzahl und Vorschubrate in einem gleichmäßigen Zyklus (kontinuierlicher Vorschub) bis zur gewünschten Bohrungstiefe bohren (ohne zu lüften).

#### ■ 5. Durchbohren

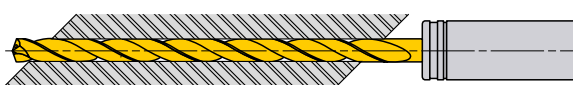

- ① Reduzieren Sie den Vorschub beim Austritt aus der Bohrung, um Beschädigungen an der Schneidkante zu vermeiden.

#### ■ 6. Herausfahren des Bohrers

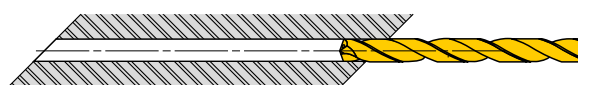

- ① Reduzieren Sie nach Erreichen der Bohrtiefe die Drehzahl 500 – 1000 min<sup>-1</sup>. Fahren Sie den Bohrer als nächstes bei einer Vorschubrate von 1000 – 2000 mm/min heraus.

## ■ BEDIENHINWEISE FÜR DVAS L/D=50

### BOHREN AUF EINER EBENEN FLÄCHE

#### ■ 1. Pilotbohrung setzen

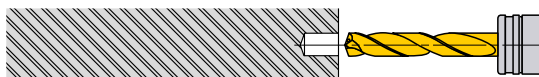

- ① Verwenden Sie einen Bohrer mit einem größeren (flacheren) Spitzenwinkel als die extralange Version. Verwenden Sie einen DVAS-Bohrer mit  $L/D = 7$ .
- ② Sicherstellen, dass für die Führung ein hochpräzises Loch gebohrt wird.
- ③ Bohrtiefe: Ca.  $DC \times 7$ .  
(Passen Sie die Tiefe der Pilotbohrung an die Länge des Tieflochbohrers an.)

#### ■ 2. Einfahren in die Pilotbohrung



- ① Mit niedriger Drehzahl in die Pilotbohrung einfahren. (Spindeldrehzahl von  $500 - 1000 \text{ min}^{-1}$ , Vorschubrate von  $1000 - 2000 \text{ mm/min}$ )
- ② Tieflochbohrer  $0.5 - 1 \text{ mm}$  vor dem Boden der Pilotbohrung stoppen

#### ■ 3. Tieflochbohren

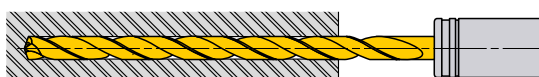

- ① Mit der empfohlenen Drehzahl und Vorschubrate in einem gleichmäßigen Zyklus (kontinuierlicher Vorschub) bis zur gewünschten Bohrungstiefe bohren (ohne zu lüften).

#### ■ 4. Herausfahren des Tieflochbohrers

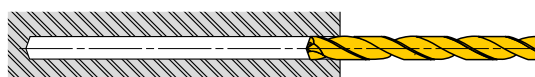

- ① Reduzieren Sie die nach Erreichen der Bohrtiefe die Drehzahl ca.  $0.5 - 1 \text{ mm}$  vor dem Bohrungsgrund. (Drehzahl von ca.  $500 - 1000 \text{ min}^{-1}$ )
- ② Fahren Sie den Bohrer als nächstes bei einer Vorschubrate von  $1000 - 2000 \text{ mm/min}$  heraus.

### BOHREN AUF UNEBENEN FLÄCHEN

#### ■ 1. Anspiegeln

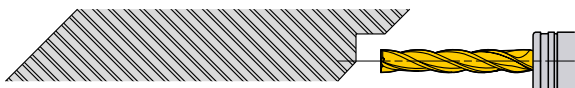

- ① Bearbeiten Sie die unebene Fläche mit einem geeigneten Schafffräser oder Flachbohrer, der zum Anspiegeln geeignet ist. Der Durchmesser der Planfläche muß mindestens so groß wie der Durchmesser des Tieflochbohrers sein (auf Durchmessertoleranzen achten).

#### ■ 2. Pilotbohrung setzen

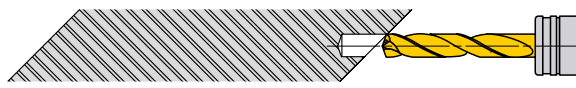

- ① Verwenden Sie einen Bohrer mit einem größeren (flacheren) Spitzenwinkel als die extralange Version. Verwenden Sie einen DVAS-Bohrer mit  $L/D = 7$ .
- ② Sicherstellen, dass für die Führung ein hochpräzises Loch gebohrt wird.
- ③ Bohrtiefe: Ca.  $DC \times 7$ .  
(Passen Sie die Tiefe der Pilotbohrung an die Länge des Tieflochbohrers an.)

#### ■ 3. Einfahren in die Pilotbohrung



- ① Führen Sie den Bohrer bei einer niedrigen Drehzahl in die Pilotbohrung ein. (Spindeldrehzahl von  $500 - 1000 \text{ min}^{-1}$ , Vorschubrate von  $1000 - 2000 \text{ mm/min}$ )
- ② Tieflochbohrer  $0.5 - 1 \text{ mm}$  vor dem Boden der Pilotbohrung stoppen.

#### ■ 4. Tieflochbohren

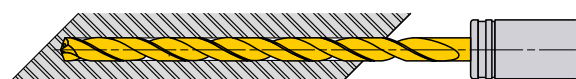

- ① Mit der empfohlenen Drehzahl und Vorschubrate in einem gleichmäßigen Zyklus (kontinuierlicher Vorschub) bis zur gewünschten Bohrungstiefe bohren (ohne zu lüften).

#### ■ 5. Durchbohren

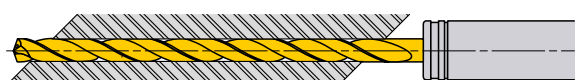

- ① Reduzieren Sie den Vorschub beim Austritt aus der Bohrung, um Beschädigungen an der Schneidkante zu vermeiden.

#### ■ 6. Herausfahren des Bohrers

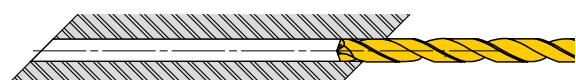

- ① Reduzieren Sie nach Erreichen der Bohrtiefe die Drehzahl auf  $500 - 1000 \text{ min}^{-1}$ .
- ② Fahren Sie den Bohrer als nächstes bei einer Vorschubrate von  $1000 - 2000 \text{ mm/min}$  heraus.

# BOHREN (VOLLHARTMETALL)

## DVAS Minibohrer TRISTAR-Bohrer

**NEW**

HARTMETALL

M  
BOHREN

### EINSATZHINWEISE

#### Bohreraufnahme

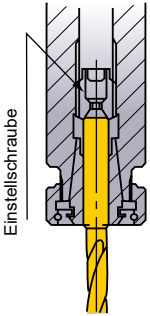

Einstellschraube

Präzisionsspannzangen können verwendet werden.

#### Max. Bohrtiefe

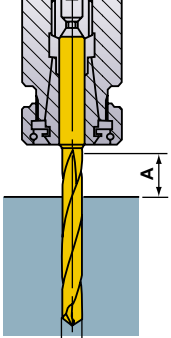

$A \geq DC \times 2$

#### Bohrer-Einstellung

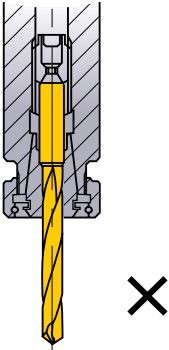

Nicht auf den Nuten spannen.

#### Kühlmitteldruck

Stellen Sie den Kühlmitteldruck entsprechend der Art und Konzentration des Kühlmittels ein.

Bohrer Durchm. DC	Wasserlöslich	Nicht wasserlöslich
DC < 2mm	≥ 3MPa	≥ 7MPa
DC < 3mm	≥ 2MPa	≥ 5MPa

#### Pilotbohrer

Beachten Sie für das Tieflochbohren die folgende Abbildung.

$L/D \leq 40$



DC x 3

Verwenden Sie den DVAS X02S040  
\*L/D = 2 kann auf bis zu DC x 3 bearbeitet werden, wenn Pilotbohrungen gebohrt werden.

$L/D > 40$

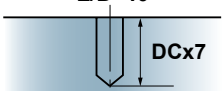

DC x 7

Verwenden Sie den DVAS X07S040

#### Handling mit Kühlmittel

Kleine Spanpartikel können das Ölloch von Bohrern mit kleinem Durchmesser blockieren. Verwenden Sie als Präventivmaßnahme immer einen feinmaschigen Filter.

Bohrer Durchm. DC	Feinmaschiger Filter
DC < 2mm	≤ 10µm
DC < 3mm	≤ 20µm

#### Dünne Werkstücke

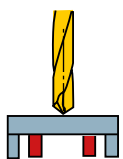

Stützen Sie das Werkstück.  
**OK**

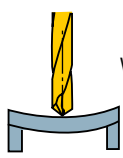

Wenn Werkstücke verbiegen...  
**X**

#### Unterbrochene Bearbeitung

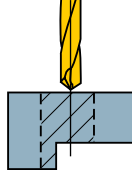

Ohne Vorbearbeitung  
**OK**

① Reduzieren Sie den Vorschub an der unterbrochenen Stelle.

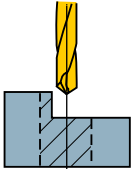

Benötigt Vorbearbeitung

① Planen Sie die Fläche mit einem Fräser vorab.

#### Stufenbohrungen

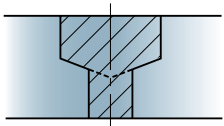

① Geteilt in 2 Prozesse.  
② Bohren Sie das größere Loch zuerst.  
\*Auf Anfrage bieten wir auch Stufenbohrer an, die Stufenbohrungen in einem Prozess herstellen können.

#### Gratbildung oder Ausbrüche am Werkstück

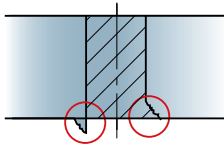

① Reduzieren Sie den Vorschub um ca. 50% beim Austritt.  
② Tauschen Sie den Bohrer durch einen anderen mit größerem Spitzenwinkel.

## Tipps für das Tieflochbohren oberhalb von $L/D = 40$

### Werkstückrotationsverfahren: kleine Drehbänke, automatische Drehmaschinen usw.

(1) Ansenken (DLE-Bohrer empfohlen)



(2) Bohren Sie die Pilotbohrung bis auf eine Tiefe von ca.  $3D$  (DVAS-Bohrer empfohlen).



(3) Bohren Sie das Tiefloch mit DVAS $\odot\odot\odot\odot$ X50S040.



### Werkzeugrotationsverfahren: Bearbeitungszentren, Verbundmaschinen usw.

(1) Bohren Sie die Pilotbohrung bis auf eine Tiefe von ca.  $3D$  (DVAS-Bohrer empfohlen).



(2) Bohren Sie die Pilotbohrung tiefer bis auf ca.  $7D$ .

Falls mehr Stabilität benötigt wird, bohren Sie eine Pilotbohrung tiefer als  $7D$ .



(3) Bohren Sie das Tiefloch mit DVAS $\odot\odot\odot\odot$ X50S040.



# Notizen

---

A series of horizontal dashed lines for writing notes, spanning the width of the page.



# Notizen

---

A series of horizontal dashed lines for writing notes, spanning the width of the page.

# Notizen

---

A series of horizontal dashed lines for writing notes, spanning the width of the page.

# Notizen

---

A series of horizontal dashed lines for writing notes, spanning the width of the page.

# Notizen

---

A series of horizontal dashed lines for writing notes, spanning the width of the page.

# Notizen

---

A series of horizontal dashed lines for writing notes, spanning the width of the page.

# Notizen

---

A series of horizontal dashed lines for writing notes, spanning the width of the page.

# BOHREN (VOLLHARTMETALL)

## MINI-MVS

- Gerade Schneidkanten für verbesserte Spanabfuhr und erhöhte Schneidkantenstabilität.
- 4 Führungsfasen erzielen eine optimale Bohrlochqualität und Präzision.



HARTMETALL



Interne Kühlung

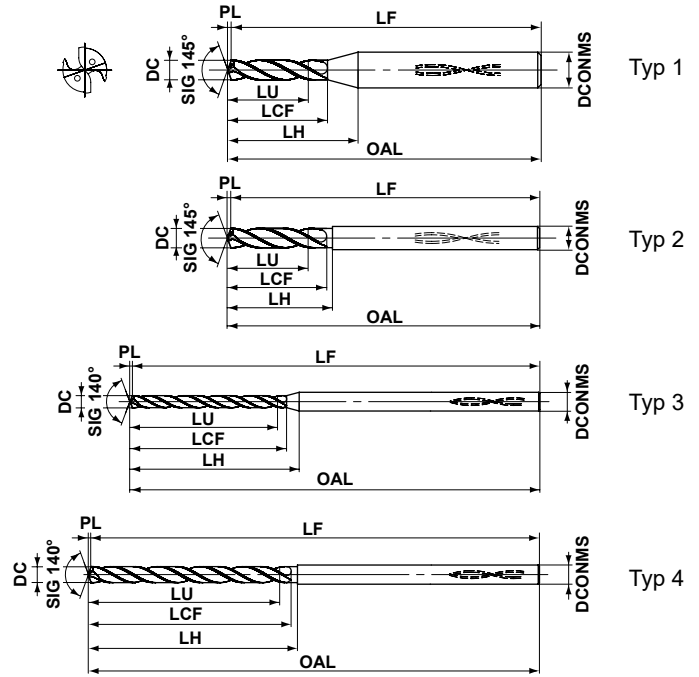
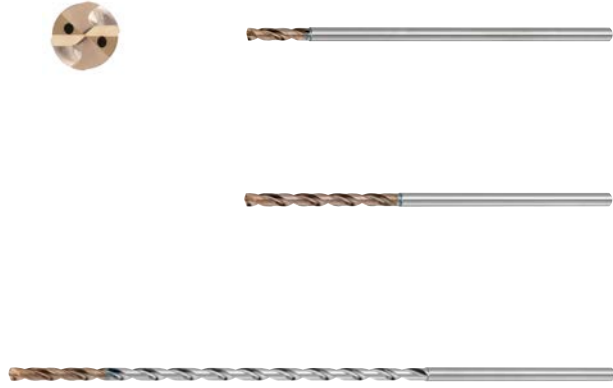

M  
BOHREN

Bestellnummer	1 ≤ DC ≤ 2.9
MVS-X02- (Pilotbohrer)	+0.014 0
Andere	0 -0.014
Bestellnummer	DCONMS
MVS	0 -0.006

DC (mm)	Bohr- tiefe (L/D)	DP1020	Bestellnummer	Abmessungen (mm)							Typ
				LU	LCF	LH	OAL	LF	PL	DCONMS	
1.0	2*	●	MVS0100X02S030	2.2	5.2	8.9	55.2	55	0.2	3	1
	7	●	MVS0100X07S030	7.2	10.2	14.2	55.2	55	0.2	3	3
	12	●	MVS0100X12S030	12.2	15.2	19.2	55.2	55	0.2	3	3
	20	●	MVS0100X20S030	20.2	24.2	28.2	60.2	60	0.2	3	3
	25	●	MVS0100X25S030	25.2	28.2	32.2	66.2	66	0.2	3	3
	30	●	MVS0100X30S030	30.2	33.2	37.2	72.2	72	0.2	3	3
1.1	2*	●	MVS0110X02S030	2.4	5.6	9.1	55.2	55	0.2	3	1
	7	●	MVS0110X07S030	7.9	11.2	15.2	55.2	55	0.2	3	3
	12	●	MVS0110X12S030	13.4	17.2	21.2	55.2	55	0.2	3	3
	20	●	MVS0110X20S030	22.2	25.2	29.2	60.2	60	0.2	3	3
	25	●	MVS0110X25S030	27.7	31.2	34.2	66.2	66	0.2	3	3
	30	●	MVS0110X30S030	33.2	36.2	40.2	72.2	72	0.2	3	3
1.2	2*	●	MVS0120X02S030	2.6	6.2	9.6	55.2	55	0.2	3	1
	7	●	MVS0120X07S030	8.6	12.2	15.2	55.2	55	0.2	3	3
	12	●	MVS0120X12S030	14.6	18.2	21.2	55.2	55	0.2	3	3
	20	●	MVS0120X20S030	24.2	28.2	31.2	60.2	60	0.2	3	3
	25	●	MVS0120X25S030	30.2	34.2	37.2	66.2	66	0.2	3	3
	30	●	MVS0120X30S030	36.2	40.2	43.2	72.2	72	0.2	3	3
1.3	2*	●	MVS0130X02S030	2.8	6.6	9.8	55.2	55	0.2	3	1
	7	●	MVS0130X07S030	9.3	13.2	16.2	55.2	55	0.2	3	3
	12	●	MVS0130X12S030	15.8	20.2	23.2	55.2	55	0.2	3	3
	20	●	MVS0130X20S030	26.2	30.2	33.2	68.2	68	0.2	3	3
	25	●	MVS0130X25S030	32.7	36.2	40.2	74.2	74	0.2	3	3
	30	●	MVS0130X30S030	39.2	43.2	46.2	82.2	82	0.2	3	3

DC (mm)	Bohr- tiefe (L/D)	DP1020	Bestellnummer	Abmessungen (mm)							Typ
				LU	LCF	LH	OAL	LF	PL	DCONMS	
1.4	2*	●	MVS0140X02S030	3.0	7.2	10.2	55.2	55	0.2	3	1
	7	●	MVS0140X07S030	10.1	14.3	17.3	55.3	55	0.3	3	3
	12	●	MVS0140X12S030	17.1	21.3	24.3	55.3	55	0.3	3	3
	20	●	MVS0140X20S030	28.3	32.3	35.3	68.3	68	0.3	3	3
	25	●	MVS0140X25S030	35.3	39.3	42.3	74.3	74	0.3	3	3
	30	●	MVS0140X30S030	42.3	46.3	49.3	82.3	82	0.3	3	3
1.5	2*	●	MVS0150X02S030	3.2	7.6	10.4	55.2	55	0.2	3	1
	7	●	MVS0150X07S030	10.8	15.3	18.3	55.3	55	0.3	3	3
	12	●	MVS0150X12S030	18.3	23.3	26.3	55.3	55	0.3	3	3
	20	●	MVS0150X20S030	30.3	35.3	37.3	68.3	68	0.3	3	3
	25	●	MVS0150X25S030	37.8	42.3	45.3	74.3	74	0.3	3	3
	30	●	MVS0150X30S030	45.3	50.3	52.3	82.3	82	0.3	3	3
1.6	2*	●	MVS0160X02S030	3.5	8.3	10.9	68.3	68	0.3	3	1
	7	●	MVS0160X07S030	11.5	16.3	19.3	68.3	68	0.3	3	3
	12	●	MVS0160X12S030	19.5	24.3	27.3	68.3	68	0.3	3	3
	20	●	MVS0160X20S030	32.3	37.3	39.3	78.3	78	0.3	3	3
	25	●	MVS0160X25S030	40.3	45.3	47.3	86.3	86	0.3	3	3
	30	●	MVS0160X30S030	48.3	53.3	55.3	95.3	95	0.3	3	3
1.7	2*	●	MVS0170X02S030	3.7	8.7	11.1	68.3	68	0.3	3	1
	7	●	MVS0170X07S030	12.2	17.3	19.3	68.3	68	0.3	3	3
	12	●	MVS0170X12S030	20.7	26.3	28.3	68.3	68	0.3	3	3
	20	●	MVS0170X20S030	34.3	39.3	42.3	78.3	78	0.3	3	3
	25	●	MVS0170X25S030	42.8	48.3	50.3	86.3	86	0.3	3	3
	30	●	MVS0170X30S030	51.3	56.3	59.3	95.3	95	0.3	3	3

2\* = Pilotbohrer: Toleranz +0.014 und Bohrtiefe DCx2.

● : Lagerstandard.

SCHNITTBEDINGUNGEN > M051  
ANWENDUNGSHINWEISE > M052  
TECHNISCHE DATEN > P001

M049

## MINI-MVS

HARTMETALL

M

BOHREN

DC	Bohr-tiefe (mm)	DP1020 (L/D)	Bestellnummer	Abmessungen (mm)							Typ
				LU	LCF	LH	OAL	LF	PL	DCONMS	
1.8	2*	●	MVS0180X02S030	3.9	9.3	11.5	68.3	68	0.3	3	1
	7	●	MVS0180X07S030	12.9	18.3	20.3	68.3	68	0.3	3	3
	12	●	MVS0180X12S030	21.9	27.3	29.3	68.3	68	0.3	3	3
	20	●	MVS0180X20S030	36.3	41.3	44.3	84.3	84	0.3	3	3
	25	●	MVS0180X25S030	45.3	50.3	53.3	94.3	94	0.3	3	3
	30	●	MVS0180X30S030	54.3	59.3	62.3	102.3	102	0.3	3	3
1.9	2*	●	MVS0190X02S030	4.1	9.7	11.8	68.3	68	0.3	3	1
	7	●	MVS0190X07S030	13.6	19.3	21.3	68.3	68	0.3	3	3
	12	●	MVS0190X12S030	23.1	29.3	31.3	68.3	68	0.3	3	3
	20	●	MVS0190X20S030	38.3	44.3	46.3	84.3	84	0.3	3	3
	25	●	MVS0190X25S030	47.8	53.3	55.3	94.3	94	0.3	3	3
	30	●	MVS0190X30S030	57.3	63.3	65.3	102.3	102	0.3	3	3
2.0	2*	●	MVS0200X02S030	4.3	10.3	12.2	68.3	68	0.3	3	1
	7	●	MVS0200X07S030	14.4	20.4	22.4	68.4	68	0.4	3	3
	12	●	MVS0200X12S030	24.4	30.4	32.4	68.4	68	0.4	3	3
	20	●	MVS0200X20S030	40.4	46.4	48.4	84.4	84	0.4	3	3
	25	●	MVS0200X25S030	50.4	56.4	58.4	94.4	94	0.4	3	3
	30	●	MVS0200X30S030	60.4	66.4	68.4	102.4	102	0.4	3	3
2.1	2*	●	MVS0210X02S030	4.5	10.7	12.4	74.3	74	0.3	3	1
	7	●	MVS0210X07S030	15.1	21.4	23.4	74.4	74	0.4	3	3
	12	●	MVS0210X12S030	25.6	32.4	34.4	74.4	74	0.4	3	3
	20	●	MVS0210X20S030	42.4	48.4	50.4	94.4	94	0.4	3	3
	25	●	MVS0210X25S030	52.9	59.4	60.4	107.4	107	0.4	3	3
	30	●	MVS0210X30S030	63.4	69.4	71.4	118.4	118	0.4	3	3
2.2	2*	●	MVS0220X02S030	4.7	11.3	12.8	74.3	74	0.3	3	1
	7	●	MVS0220X07S030	15.8	22.4	23.4	74.4	74	0.4	3	3
	12	●	MVS0220X12S030	26.8	33.4	34.4	74.4	74	0.4	3	3
	20	●	MVS0220X20S030	44.4	51.4	52.4	94.4	94	0.4	3	3
	25	●	MVS0220X25S030	55.4	62.4	63.4	107.4	107	0.4	3	3
	30	●	MVS0220X30S030	66.4	73.4	74.4	118.4	118	0.4	3	3
2.3	2*	●	MVS0230X02S030	5.0	11.8	13.1	74.4	74	0.4	3	1
	7	●	MVS0230X07S030	16.5	23.4	24.4	74.4	74	0.4	3	3
	12	●	MVS0230X12S030	28.0	35.4	36.4	74.4	74	0.4	3	3
	20	●	MVS0230X20S030	46.4	53.4	54.4	94.4	94	0.4	3	3
	25	●	MVS0230X25S030	57.9	64.4	66.4	107.4	107	0.4	3	3
	30	●	MVS0230X30S030	69.4	76.4	77.4	118.4	118	0.4	3	3
2.4	2*	●	MVS0240X02S030	5.2	12.4	13.5	74.4	74	0.4	3	1
	7	●	MVS0240X07S030	17.2	24.4	25.4	74.4	74	0.4	3	3
	12	●	MVS0240X12S030	29.2	36.4	37.4	74.4	74	0.4	3	3
	20	●	MVS0240X20S030	48.4	55.4	56.4	94.4	94	0.4	3	3
	25	●	MVS0240X25S030	60.4	67.4	68.4	107.4	107	0.4	3	3
	30	●	MVS0240X30S030	72.4	79.4	80.4	118.4	118	0.4	3	3
2.5	2*	●	MVS0250X02S030	5.4	12.8	13.7	74.4	74	0.4	3	1
	7	●	MVS0250X07S030	18.0	25.5	26.5	74.5	74	0.5	3	3
	12	●	MVS0250X12S030	30.5	38.5	39.5	74.5	74	0.5	3	3
	20	●	MVS0250X20S030	50.5	58.5	59.5	94.5	94	0.5	3	3
	25	●	MVS0250X25S030	63.0	70.5	71.5	107.5	107	0.5	3	3
	30	●	MVS0250X30S030	75.5	83.5	84.5	118.5	118	0.5	3	3

DC	Bohr-tiefe (mm)	DP1020 (L/D)	Bestellnummer	Abmessungen (mm)							Typ
				LU	LCF	LH	OAL	LF	PL	DCONMS	
2.6	2*	●	MVS0260X02S030	5.6	13.4	13.4	81.4	81	0.4	3	2
	7	●	MVS0260X07S030	18.7	26.5	26.5	81.5	81	0.5	3	4
	12	●	MVS0260X12S030	31.7	39.5	39.5	81.5	81	0.5	3	4
	20	●	MVS0260X20S030	52.5	60.5	60.5	103.5	103	0.5	3	4
	25	●	MVS0260X25S030	65.5	73.5	73.5	117.5	117	0.5	3	4
	30	●	MVS0260X30S030	78.5	86.5	86.5	132.5	132	0.5	3	4
2.7	2*	●	MVS0270X02S030	5.8	13.8	13.8	81.4	81	0.4	3	2
	7	●	MVS0270X07S030	19.4	27.5	27.5	81.5	81	0.5	3	4
	12	●	MVS0270X12S030	32.9	41.5	41.5	81.5	81	0.5	3	4
	20	●	MVS0270X20S030	54.5	62.5	62.5	103.5	103	0.5	3	4
	25	●	MVS0270X25S030	68.0	76.5	76.5	117.5	117	0.5	3	4
	30	●	MVS0270X30S030	81.5	89.5	89.5	132.5	132	0.5	3	4
2.8	2*	●	MVS0280X02S030	6.0	14.4	14.4	81.4	81	0.4	3	2
	7	●	MVS0280X07S030	20.1	28.5	28.5	81.5	81	0.5	3	4
	12	●	MVS0280X12S030	34.1	42.5	42.5	81.5	81	0.5	3	4
	20	●	MVS0280X20S030	56.5	64.5	64.5	103.5	103	0.5	3	4
	25	●	MVS0280X25S030	70.5	78.5	78.5	117.5	117	0.5	3	4
	30	●	MVS0280X30S030	84.5	92.5	92.5	132.5	132	0.5	3	4
2.9	2*	●	MVS0290X02S030	6.3	14.9	14.9	81.5	81	0.5	3	2
	7	●	MVS0290X07S030	20.8	29.5	29.5	81.5	81	0.5	3	4
	12	●	MVS0290X12S030	35.3	44.5	44.5	81.5	81	0.5	3	4
	20	●	MVS0290X20S030	58.5	67.5	67.5	103.5	103	0.5	3	4
	25	●	MVS0290X25S030	73.0	81.5	81.5	117.5	117	0.5	3	4
	30	●	MVS0290X30S030	87.5	96.5	96.5	132.5	132	0.5	3	4

2\* = Pilotbohrer: Toleranz +0.014 und Bohrtiefe DCx2.

● : Lagerstandard.



## SCHNITTDATENEMPFEHLUNGEN

Material		P					
		Allg. Baustahl ( $\leq 180\text{HB}$ )		C-Stahl Leg. Stahl ( $180-280\text{HB}$ )		C-Stahl Leg. Stahl ( $280-350\text{HB}$ )	
Bohrer-Durchm. DC (mm)	L/D	Drehzahl (min <sup>-1</sup> )	Vorschub (min.-max.) (mm/U.)	Drehzahl (min <sup>-1</sup> )	Vorschub (min.-max.) (mm/U.)	Drehzahl (min <sup>-1</sup> )	Vorschub (min.-max.) (mm/U.)
1.0	2*,7DC	15900	0.04 (0.02-0.05)	15900	0.04 (0.02-0.05)	12700	0.04 (0.02-0.05)
	$\geq 12\text{DC}$	15900	0.02 (0.01-0.03)	12700	0.02 (0.01-0.03)	9500	0.02 (0.01-0.03)
1.5	2*,7DC	10600	0.05 (0.03-0.08)	10600	0.05 (0.03-0.08)	8400	0.05 (0.03-0.08)
	$\geq 12\text{DC}$	10600	0.05 (0.02-0.08)	8400	0.05 (0.03-0.08)	6300	0.05 (0.02-0.08)
2.0	2*,7DC	7900	0.07 (0.04-0.10)	7900	0.07 (0.04-0.10)	6300	0.07 (0.04-0.10)
	$\geq 12\text{DC}$	7900	0.07 (0.04-0.10)	7900	0.07 (0.04-0.10)	7900	0.07 (0.04-0.10)
2.5	2*,7DC	7600	0.09 (0.05-0.13)	7600	0.09 (0.05-0.13)	6300	0.09 (0.05-0.13)
	$\geq 12\text{DC}$	7600	0.09 (0.06-0.13)	6300	0.09 (0.06-0.13)	6300	0.08 (0.05-0.13)

Material		M		K			
		Rostfreier Stahl (austenitisch) ( $\leq 200\text{HB}$ )		Grauguss ( $\leq 350\text{MPa}$ )		Duktiler Guss ( $\leq 450\text{MPa}$ )	
Bohrer-Durchm. DC (mm)	L/D	Drehzahl (min <sup>-1</sup> )	Vorschub (min.-max.) (mm/U.)	Drehzahl (min <sup>-1</sup> )	Vorschub (min.-max.) (mm/U.)	Drehzahl (min <sup>-1</sup> )	Vorschub (min.-max.) (mm/U.)
1.0	2*,7DC	9500	0.03 (0.02-0.05)	15900	0.04 (0.02-0.05)	12700	0.04 (0.02-0.05)
	$\geq 12\text{DC}$	9500	0.02 (0.01-0.03)	12700	0.02 (0.01-0.03)	9500	0.02 (0.01-0.03)
1.5	2*,7DC	6300	0.05 (0.03-0.07)	10600	0.05 (0.03-0.08)	8400	0.05 (0.03-0.08)
	$\geq 12\text{DC}$	6300	0.05 (0.02-0.08)	8400	0.05 (0.03-0.08)	6300	0.05 (0.02-0.08)
2.0	2*,7DC	4700	0.06 (0.04-0.08)	7900	0.07 (0.04-0.10)	6300	0.07 (0.04-0.10)
	$\geq 12\text{DC}$	4700	0.07 (0.04-0.10)	7900	0.07 (0.04-0.10)	7900	0.07 (0.04-0.10)
2.5	2*,7DC	5000	0.08 (0.05-0.10)	7600	0.09 (0.05-0.13)	6300	0.09 (0.05-0.13)
	$\geq 12\text{DC}$	3800	0.08 (0.05-0.12)	6300	0.09 (0.06-0.13)	6300	0.08 (0.05-0.12)

Material		N		S	
		Aluminiumleg. (Si<5%)		Hitzebeständiger Stahl	
Bohrer-Durchm. DC (mm)	L/D	Drehzahl (min <sup>-1</sup> )	Vorschub (min.-max.) (mm/U.)	Drehzahl (min <sup>-1</sup> )	Vorschub (min.-max.) (mm/U.)
1.0	2*,7DC	19000	0.05 (0.03-0.08)	3100	0.02 (0.01-0.03)
	$\geq 12\text{DC}$	15900	0.05 (0.03-0.08)	3100	0.02 (0.01-0.03)
1.5	2*,7DC	16900	0.07 (0.05-0.12)	2100	0.03 (0.02-0.04)
	$\geq 12\text{DC}$	14800	0.08 (0.05-0.12)	2100	0.03 (0.02-0.04)
2.0	2*,7DC	14300	0.10 (0.06-0.15)	2300	0.04 (0.03-0.05)
	$\geq 12\text{DC}$	12700	0.11 (0.06-0.15)	2300	0.04 (0.03-0.05)
2.5	2*,7DC	12700	0.13 (0.08-0.20)	1900	0.05 (0.04-0.06)
	$\geq 12\text{DC}$	11400	0.14 (0.08-0.20)	1900	0.05 (0.04-0.06)

2\* = Pilotbohrer: Die Bohrtiefe beträgt DCx2.

## ■ BEDIENHINWEISE FÜR MINI-MVS-TIEFLOCHBOHRER (L/D ≥ 10)

### BOHREN AUF EINER EBENEN FLÄCHE

#### ■ 1. Pilotbohrung setzen

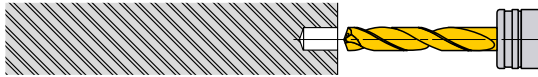

- ① Verwenden Sie den kürzestmöglichen Mini-MVS-Bohrer.
- ② Die Pilotbohrung muss ca. 1DC oder tiefer sein (auf Präzision achten).

#### ■ 2. Einfahren in die Pilotbohrung

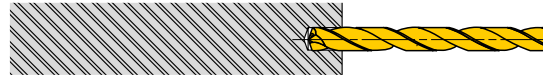

- ① Mit niedriger Drehzahl in die Pilotbohrung einfahren. (Drehzahl 500 min<sup>-1</sup>, Vorschub 0.2 – 0.3mm/U)
- ② Tieflochbohrer 0.5–1mm vor dem Boden der Pilotbohrung stoppen.

#### ■ 3. Tieflochbohren

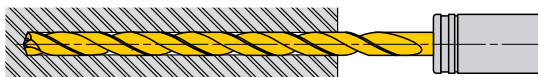

- ① Mit der empfohlenen Drehzahl und Vorschubrate in einem gleichmäßigen Zyklus (kontinuierlicher Vorschub) bis zur gewünschten Bohrungstiefe bohren (ohne zu lüften).

#### ■ 4. Herausfahren des Tieflochbohrers

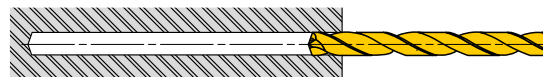

- ① Reduzieren Sie nach Erreichen der Bohrtiefe die Drehzahl. (Drehzahl 500min<sup>-1</sup>)
- ② Bohrer bis zur Tiefe der Pilotbohrung (1DC) bei einem Vorschub von 3000mm/min zurückfahren.
- ③ Fahren Sie den Bohrer anschließend mit einem Vorschub von 0.2–0.3mm/U ganz heraus.

### BOHREN AUF UNEBENEN FLÄCHEN

#### ■ 1. Anspiegeln



- ① Bearbeiten Sie die unebene Fläche mit einem geeigneten Schaffräser oder Flachbohrer, der zum Anspiegeln geeignet ist. Der Durchmesser der Planfläche muss mindestens so groß wie der Durchmesser des Tieflochbohrers sein (auf Durchmessertoleranzen achten).

#### ■ 2. Pilotbohrung setzen



- ① Verwenden Sie den kürzestmöglichen Mini-MVS-Bohrer.
- ② Die Pilotbohrung muss ca. 1DC oder tiefer sein (auf Präzision achten).

#### ■ 3. Einfahren in die Pilotbohrung



- ① Mit niedriger Drehzahl in die Pilotbohrung einfahren. (Drehzahl 500 min<sup>-1</sup>, Vorschub 0.2 – 0.3mm/U)
- ② Tieflochbohrer 0.5–1mm vor dem Boden der Pilotbohrung stoppen.

#### ■ 4. Tieflochbohren

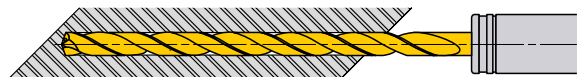

- ① Mit der empfohlenen Drehzahl und Vorschubrate in einem gleichmäßigen Zyklus (kontinuierlicher Vorschub) bis zur gewünschten Bohrungstiefe bohren (ohne zu lüften).

#### ■ 5. Durchbohren

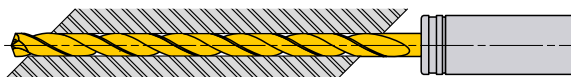

- ① Reduzieren Sie den Vorschub beim Austritt aus der Bohrung, um Beschädigungen an der Schneidkante zu vermeiden.

#### ■ 6. Herausfahren des Bohrers



- ① Reduzieren Sie nach Erreichen der Bohrtiefe die Drehzahl. (Drehzahl 500min<sup>-1</sup>)
- ② Bohrer bis zur Tiefe der Pilotbohrung (1DC) bei einem Vorschub von 3000mm/min zurückfahren.
- ③ Fahren Sie den Bohrer anschließend mit einem Vorschub von 0.2–0.3mm/U ganz heraus.

# MINI-MWS

- Mini VHM-Bohrer mit internen Kühlmittelkanälen für stabiles Tieflochbohren.
- Für äußerst präzises und effizientes Bohren von C-Stahl bis hin zu schwer zerspanbarer Materialien.



HARTMETALL



	$0.5 \leq DC < 1$
	$+0.009$
	$0$
	$0$
	$-0.006$

Interne Kühlung

■ Typ SB  
(Für Pilotbohrungen)

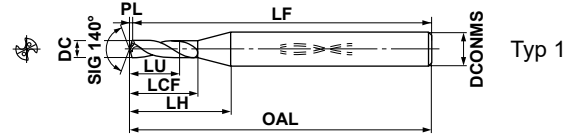

M  
BOHREN

■ Typ LB/XB

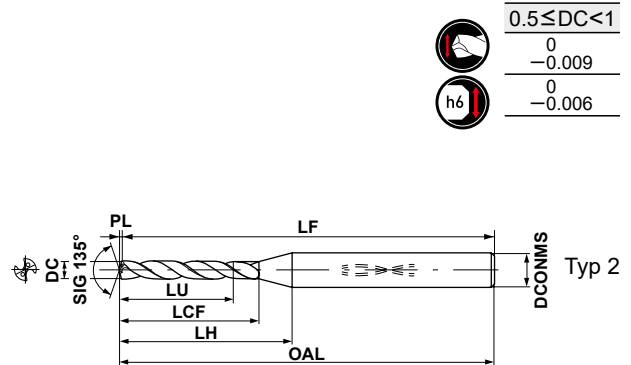

● Die MWS-Bohrer eignen sich für die Verwendung mit Schrumpfaufnahmen.

DC (mm)	Bohr- tiefe (L/D)	VP15TF	Bestellnummer	Abmessungen (mm)							Typ
				LU	LCF	LH	OAL	LF	PL	DCONMS	
0.50	1	●	MWS0050SB	0.6	2.6	7.3	47.1	47	0.09	3	1
	5	★	MWS0050LB	2.6	8.1	13.1	47.1	47	0.10	3	2
	12	★	MWS0050XB	6.1	16.1	21.1	47.1	47	0.10	3	2
0.51	1	★	MWS0051SB	0.6	2.7	7.3	47.1	47	0.09	3	1
	5	★	MWS0051LB	2.7	8.1	13.1	47.1	47	0.11	3	2
	12	★	MWS0051XB	6.2	16.1	21.1	47.1	47	0.11	3	2
0.52	1	★	MWS0052SB	0.6	2.7	7.3	47.1	47	0.09	3	1
	5	★	MWS0052LB	2.7	8.1	13.1	47.1	47	0.11	3	2
	12	★	MWS0052XB	6.4	16.1	21.1	47.1	47	0.11	3	2
0.53	1	★	MWS0053SB	0.6	2.7	7.3	47.1	47	0.10	3	1
	5	★	MWS0053LB	2.8	8.1	13.1	47.1	47	0.11	3	2
	12	★	MWS0053XB	6.5	16.1	21.1	47.1	47	0.11	3	2
0.54	1	★	MWS0054SB	0.6	2.7	7.3	47.1	47	0.10	3	1
	5	★	MWS0054LB	2.8	8.1	13.1	47.1	47	0.11	3	2
	12	★	MWS0054XB	6.6	16.1	21.1	47.1	47	0.11	3	2
0.55	1	●	MWS0055SB	0.7	2.7	7.3	47.1	47	0.10	3	1
	5	★	MWS0055LB	2.9	8.1	13.1	47.1	47	0.11	3	2
	12	★	MWS0055XB	6.7	16.1	21.1	47.1	47	0.11	3	2
0.56	1	★	MWS0056SB	0.7	3.0	7.6	47.1	47	0.10	3	1
	5	★	MWS0056LB	2.9	8.1	13.1	47.1	47	0.12	3	2
	12	★	MWS0056XB	6.8	16.1	21.1	47.1	47	0.12	3	2
0.57	1	★	MWS0057SB	0.7	3.0	7.5	47.1	47	0.10	3	1
	5	★	MWS0057LB	3.0	8.1	13.1	47.1	47	0.12	3	2
	12	★	MWS0057XB	7.0	16.1	21.1	47.1	47	0.12	3	2

DC (mm)	Bohr- tiefe (L/D)	VP15TF	Bestellnummer	Abmessungen (mm)							Typ
				LU	LCF	LH	OAL	LF	PL	DCONMS	
0.58	1	★	MWS0058SB	0.7	3.0	7.5	47.1	47	0.11	3	1
	5	★	MWS0058LB	3.0	8.1	13.1	47.1	47	0.12	3	2
	12	★	MWS0058XB	7.1	16.1	21.1	47.1	47	0.12	3	2
0.59	1	★	MWS0059SB	0.7	3.0	7.5	47.1	47	0.11	3	1
	5	★	MWS0059LB	3.1	8.1	12.1	47.1	47	0.12	3	2
	12	★	MWS0059XB	7.2	16.1	20.1	47.1	47	0.12	3	2
0.60	1	●	MWS0060SB	0.7	3.0	7.5	47.1	47	0.11	3	1
	5	★	MWS0060LB	3.1	8.1	12.1	47.1	47	0.12	3	2
	12	★	MWS0060XB	7.3	16.1	20.1	47.1	47	0.12	3	2
0.61	1	★	MWS0061SB	0.7	3.2	7.7	47.1	47	0.11	3	1
	5	★	MWS0061LB	3.2	8.1	12.1	47.1	47	0.13	3	2
	12	★	MWS0061XB	7.5	16.1	20.1	47.1	47	0.13	3	2
0.62	1	★	MWS0062SB	0.7	3.2	7.6	47.1	47	0.11	3	1
	5	★	MWS0062LB	3.2	8.1	12.1	47.1	47	0.13	3	2
	12	★	MWS0062XB	7.6	16.1	20.1	47.1	47	0.13	3	2
0.63	1	★	MWS0063SB	0.7	3.2	7.6	47.1	47	0.11	3	1
	5	★	MWS0063LB	3.3	8.1	12.1	47.1	47	0.13	3	2
	12	★	MWS0063XB	7.7	16.1	20.1	47.1	47	0.13	3	2
0.64	1	★	MWS0064SB	0.8	3.2	7.6	47.1	47	0.12	3	1
	5	★	MWS0064LB	3.3	8.1	12.1	47.1	47	0.13	3	2
	12	★	MWS0064XB	7.8	16.1	20.1	47.1	47	0.13	3	2
0.65	1	●	MWS0065SB	0.8	3.2	7.6	47.1	47	0.12	3	1
	5	★	MWS0065LB	3.4	8.1	12.1	47.1	47	0.13	3	2
	12	★	MWS0065XB	7.9	16.1	20.1	47.1	47	0.13	3	2

Hinweis 1) Bei Bedarf von abweichenden Geometrien setzen Sie sich mit uns in Verbindung.  
(Andere Durchmesser und Längen können bestellt werden).

● : Lagerstandard. ★ : Lagerstandard in Japan.

ANWENDUNGSHINWEISE > M056  
SCHNITTBEDINGUNGEN > M055

ANWENDUNGSHINWEISE > M056  
TECHNISCHE DATEN > P001

M053

## MINI-MWS

HARTMETALL

M

BOHREN

DC	Bohr-tiefe	VP15TF	Bestellnummer	Abmessungen (mm)							Typ
				LU	LCF	LH	OAL	LF	PL	DCONMS	
0.66	1	★	MWS0066SB	0.8	3.5	7.9	47.1	47	0.12	3	1
	5	★	MWS0066LB	3.4	8.1	12.1	47.1	47	0.14	3	2
	12	★	MWS0066XB	8.1	16.1	20.1	47.1	47	0.14	3	2
0.67	1	★	MWS0067SB	0.8	3.5	7.8	47.1	47	0.12	3	1
	5	★	MWS0067LB	3.5	8.1	12.1	47.1	47	0.14	3	2
	12	★	MWS0067XB	8.2	16.1	20.1	47.1	47	0.14	3	2
0.68	1	★	MWS0068SB	0.8	3.5	7.8	47.1	47	0.12	3	1
	5	★	MWS0068LB	3.5	8.1	12.1	47.1	47	0.14	3	2
	12	★	MWS0068XB	8.3	16.1	20.1	47.1	47	0.14	3	2
0.69	1	★	MWS0069SB	0.8	3.5	7.8	47.1	47	0.13	3	1
	5	★	MWS0069LB	3.6	8.1	12.1	47.1	47	0.14	3	2
	12	★	MWS0069XB	8.4	16.1	20.1	47.1	47	0.14	3	2
0.70	1	●	MWS0070SB	0.8	3.5	7.8	47.1	47	0.13	3	1
	5	★	MWS0070LB	3.6	8.1	12.1	47.1	47	0.14	3	2
	12	★	MWS0070XB	8.5	16.1	20.1	47.1	47	0.14	3	2
0.71	1	★	MWS0071SB	0.8	3.7	8.0	50.1	50	0.13	3	1
	5	★	MWS0071LB	3.7	10.1	14.1	50.1	50	0.15	3	2
	12	★	MWS0071XB	8.7	20.1	24.1	50.1	50	0.15	3	2
0.72	1	★	MWS0072SB	0.9	3.7	8.0	50.1	50	0.13	3	1
	5	★	MWS0072LB	3.8	10.1	14.1	50.1	50	0.15	3	2
	12	★	MWS0072XB	8.8	20.1	24.1	50.1	50	0.15	3	2
0.73	1	★	MWS0073SB	0.9	3.7	7.9	50.1	50	0.13	3	1
	5	★	MWS0073LB	3.8	10.1	14.1	50.1	50	0.15	3	2
	12	★	MWS0073XB	8.9	20.1	24.1	50.1	50	0.15	3	2
0.74	1	★	MWS0074SB	0.9	3.7	7.9	50.1	50	0.13	3	1
	5	★	MWS0074LB	3.9	10.1	14.1	50.1	50	0.15	3	2
	12	★	MWS0074XB	9.0	20.1	24.1	50.1	50	0.15	3	2
0.75	1	●	MWS0075SB	0.9	3.7	7.9	50.1	50	0.14	3	1
	5	★	MWS0075LB	3.9	10.1	14.1	50.1	50	0.16	3	2
	12	★	MWS0075XB	9.2	20.1	24.1	50.1	50	0.16	3	2
0.76	1	★	MWS0076SB	0.9	4.0	8.2	50.1	50	0.14	3	1
	5	★	MWS0076LB	4.0	10.1	14.1	50.1	50	0.16	3	2
	12	★	MWS0076XB	9.3	20.1	24.1	50.1	50	0.16	3	2
0.77	1	★	MWS0077SB	0.9	4.0	8.2	50.1	50	0.14	3	1
	5	★	MWS0077LB	4.0	10.1	14.1	50.1	50	0.16	3	2
	12	★	MWS0077XB	9.4	20.1	24.1	50.1	50	0.16	3	2
0.78	1	★	MWS0078SB	0.9	4.0	8.1	50.1	50	0.14	3	1
	5	★	MWS0078LB	4.1	10.1	14.1	50.1	50	0.16	3	2
	12	★	MWS0078XB	9.5	20.1	24.1	50.1	50	0.16	3	2
0.79	1	★	MWS0079SB	0.9	4.0	8.1	50.1	50	0.14	3	1
	5	★	MWS0079LB	4.1	10.1	14.1	50.1	50	0.16	3	2
	12	★	MWS0079XB	9.6	20.1	24.1	50.1	50	0.16	3	2
0.80	1	●	MWS0080SB	1.0	4.1	8.2	50.2	50	0.15	3	1
	5	★	MWS0080LB	4.2	10.2	14.2	50.2	50	0.17	3	2
	12	★	MWS0080XB	9.8	20.2	24.2	50.2	50	0.17	3	2
0.81	1	★	MWS0081SB	1.0	4.3	8.4	50.2	50	0.15	3	1
	5	★	MWS0081LB	4.2	10.2	14.2	50.2	50	0.17	3	2
	12	★	MWS0081XB	9.9	20.2	24.2	50.2	50	0.17	3	2
0.82	1	★	MWS0082SB	1.0	4.3	8.4	50.2	50	0.15	3	1
	5	★	MWS0082LB	4.3	10.2	14.2	50.2	50	0.17	3	2
	12	★	MWS0082XB	10.0	20.2	24.2	50.2	50	0.17	3	2

DC	Bohr-tiefe	VP15TF	Bestellnummer	Abmessungen (mm)							Typ
				LU	LCF	LH	OAL	LF	PL	DCONMS	
0.83	1	★	MWS0083SB	1.0	4.3	8.3	50.2	50	0.15	3	1
	5	★	MWS0083LB	4.3	10.2	14.2	50.2	50	0.17	3	2
	12	★	MWS0083XB	10.1	20.2	24.2	50.2	50	0.17	3	2
0.84	1	★	MWS0084SB	1.0	4.3	8.3	50.2	50	0.15	3	1
	5	★	MWS0084LB	4.4	10.2	14.2	50.2	50	0.17	3	2
	12	★	MWS0084XB	10.3	20.2	24.2	50.2	50	0.17	3	2
0.85	1	●	MWS0085SB	1.0	4.3	8.3	50.2	50	0.15	3	1
	5	★	MWS0085LB	4.4	10.2	14.2	50.2	50	0.18	3	2
	12	★	MWS0085XB	10.4	20.2	24.2	50.2	50	0.18	3	2
0.86	1	★	MWS0086SB	1.0	4.6	8.6	50.2	50	0.16	3	1
	5	★	MWS0086LB	4.5	10.2	14.2	50.2	50	0.18	3	2
	12	★	MWS0086XB	10.5	20.2	24.2	50.2	50	0.18	3	2
0.87	1	★	MWS0087SB	1.0	4.6	8.6	50.2	50	0.16	3	1
	5	★	MWS0087LB	4.5	10.2	14.2	50.2	50	0.18	3	2
	12	★	MWS0087XB	10.6	20.2	24.2	50.2	50	0.18	3	2
0.88	1	★	MWS0088SB	1.0	4.6	8.6	50.2	50	0.16	3	1
	5	★	MWS0088LB	4.6	10.2	14.2	50.2	50	0.18	3	2
	12	★	MWS0088XB	10.7	20.2	24.2	50.2	50	0.18	3	2
0.89	1	★	MWS0089SB	1.1	4.6	8.5	50.2	50	0.16	3	1
	5	★	MWS0089LB	4.6	10.2	14.2	50.2	50	0.18	3	2
	12	★	MWS0089XB	10.9	20.2	24.2	50.2	50	0.18	3	2
0.90	1	●	MWS0090SB	1.1	4.6	8.5	50.2	50	0.16	3	1
	5	★	MWS0090LB	4.7	10.2	14.2	50.2	50	0.19	3	2
	12	★	MWS0090XB	11.0	20.2	24.2	50.2	50	0.19	3	2
0.91	1	★	MWS0091SB	1.1	4.8	8.7	50.2	50	0.17	3	1
	5	★	MWS0091LB	4.7	10.2	14.2	50.2	50	0.19	3	2
	12	★	MWS0091XB	11.1	20.2	24.2	50.2	50	0.19	3	2
0.92	1	★	MWS0092SB	1.1	4.8	8.7	50.2	50	0.17	3	1
	5	★	MWS0092LB	4.8	10.2	14.2	50.2	50	0.19	3	2
	12	★	MWS0092XB	11.2	20.2	24.2	50.2	50	0.19	3	2
0.93	1	★	MWS0093SB	1.1	4.8	8.7	50.2	50	0.17	3	1
	5	★	MWS0093LB	4.8	10.2	14.2	50.2	50	0.19	3	2
	12	★	MWS0093XB	11.4	20.2	24.2	50.2	50	0.19	3	2
0.94	1	★	MWS0094SB	1.1	4.8	8.6	50.2	50	0.17	3	1
	5	★	MWS0094LB	4.9	10.2	14.2	50.2	50	0.19	3	2
	12	★	MWS0094XB	11.5	20.2	24.2	50.2	50	0.19	3	2
0.95	1	●	MWS0095SB	1.1	4.8	8.6	50.2	50	0.17	3	1
	5	★	MWS0095LB	5.0	10.2	14.2	50.2	50	0.20	3	2
	12	★	MWS0095XB	11.6	20.2	24.2	50.2	50	0.20	3	2
0.96	1	★	MWS0096SB	1.1	5.1	8.9	50.2	50	0.17	3	1
	5	★	MWS0096LB	5.0	10.2	14.2	50.2	50	0.20	3	2
	12	★	MWS0096XB	11.7	20.2	24.2	50.2	50	0.20	3	2
0.97	1	★	MWS0097SB	1.2	5.1	8.9	50.2	50	0.18	3	1
	5	★	MWS0097LB	5.1	10.2	14.2	50.2	50	0.20	3	2
	12	★	MWS0097XB	11.8	20.2	24.2	50.2	50	0.20	3	2
0.98	1	★	MWS0098SB	1.2	5.1	8.9	50.2	50	0.18	3	1
	5	★	MWS0098LB	5.1	10.2	14.2	50.2	50	0.20	3	2
	12	★	MWS0098XB	12.0	20.2	24.2	50.2	50	0.20	3	2
0.99	1	★	MWS0099SB	1.2	5.1	8.9	50.2	50	0.18	3	1
	5	★	MWS0099LB	5.2	10.2	14.2	50.2	50	0.21	3	2
	12	★	MWS0099XB	12.1	20.2	24.2	50.2	50	0.21	3	2

Hinweis 1) Bei Bedarf von abweichenden Geometrien setzen Sie sich mit uns in Verbindung. (Andere Durchmesser und Längen können bestellt werden).

● : Lagerstandard. ★ : Lagerstandard in Japan.

## SCHNITTDATENEMPFEHLUNGEN

### SB/LB/XB-Bohrer (L/D<10)

Material	P							
	Allg. Baustahl ( $\leq 180\text{HB}$ )				C-Stahl, Leg. Stahl (180–280HB)			
	Ck10				Ck45, 42CrMo4			
Bohrer Durchm. DC (mm)	Schnittgeschw. (m/min)	Drehzahl ( $\text{min}^{-1}$ )	Vorschub (min.–max.) (mm/U.)	Tischvorschub (mm/min)	Schnittgeschw. (m/min)	Drehzahl ( $\text{min}^{-1}$ )	Vorschub (min.–max.) (mm/U.)	Tischvorschub (mm/min)
<b>0.5</b>	40	25400	0.010 (0.005–0.015)	250	40	25400	0.010 (0.005–0.015)	250
<b>0.63</b>	40	20200	0.014 (0.008–0.020)	280	40	20200	0.014 (0.008–0.020)	280
<b>0.8</b>	45	17900	0.028 (0.016–0.040)	500	45	17900	0.028 (0.016–0.040)	500
<b>1.0</b>	50	15900	0.035 (0.020–0.050)	555	50	15900	0.035 (0.020–0.050)	555

Material	P				M			
	C-Stahl, Leg. Stahl (280–350HB)				Rostfreier Stahl (austenitisch) ( $\leq 200\text{HB}$ )			
	36CrNiMo4				X5CrNi1810, X5CrNiMo17-12-2			
Bohrer Durchm. DC (mm)	Schnittgeschw. (m/min)	Drehzahl ( $\text{min}^{-1}$ )	Vorschub (min.–max.) (mm/U.)	Tischvorschub (mm/min)	Schnittgeschw. (m/min)	Drehzahl ( $\text{min}^{-1}$ )	Vorschub (min.–max.) (mm/U.)	Tischvorschub (mm/min)
<b>0.5</b>	30	19000	0.010 (0.005–0.015)	190	20	12700	0.008 (0.005–0.010)	100
<b>0.63</b>	30	15100	0.014 (0.008–0.020)	210	20	10100	0.010 (0.008–0.013)	100
<b>0.8</b>	35	13900	0.028 (0.016–0.040)	385	25	9900	0.020 (0.016–0.026)	195
<b>1.0</b>	40	12700	0.035 (0.020–0.050)	440	30	9500	0.030 (0.020–0.044)	285

Material	K							
	Grauguss ( $\leq 350\text{MPa}$ )				Duktiler Guss ( $\leq 450\text{MPa}$ )			
	GG30				GGG45			
Bohrer Durchm. DC (mm)	Schnittgeschw. (m/min)	Drehzahl ( $\text{min}^{-1}$ )	Vorschub (min.–max.) (mm/U.)	Tischvorschub (mm/min)	Schnittgeschw. (m/min)	Drehzahl ( $\text{min}^{-1}$ )	Vorschub (min.–max.) (mm/U.)	Tischvorschub (mm/min)
<b>0.5</b>	40	25400	0.010 (0.005–0.015)	250	30	19000	0.010 (0.005–0.015)	190
<b>0.63</b>	40	20200	0.014 (0.008–0.020)	280	30	15100	0.014 (0.008–0.020)	210
<b>0.8</b>	45	17900	0.028 (0.016–0.040)	500	35	13900	0.028 (0.016–0.040)	385
<b>1.0</b>	50	15900	0.035 (0.020–0.050)	555	40	12700	0.035 (0.020–0.050)	440

Material	N				S			
	Aluminiumleg. (Si<5%)				Hitzebeständiger Stahl			
					Inconel <sup>®</sup> 718			
Bohrer Durchm. DC (mm)	Schnittgeschw. (m/min)	Drehzahl ( $\text{min}^{-1}$ )	Vorschub (min.–max.) (mm/U.)	Tischvorschub (mm/min)	Schnittgeschw. (m/min)	Drehzahl ( $\text{min}^{-1}$ )	Vorschub (min.–max.) (mm/U.)	Tischvorschub (mm/min)
<b>0.5</b>	40	25400	0.014 (0.008–0.020)	355	10	6300	0.006 (0.004–0.008)	35
<b>0.63</b>	40	20200	0.020 (0.012–0.030)	400	10	5000	0.008 (0.007–0.010)	40
<b>0.8</b>	45	17900	0.036 (0.024–0.050)	640	10	3900	0.016 (0.013–0.021)	60
<b>1.0</b>	60	19000	0.050 (0.030–0.075)	950	10	3100	0.020 (0.016–0.027)	60

## MINI-MWS

HARTMETALL

M  
BOHREN

### EINSATZHINWEISE

**Bohreraufnahme**

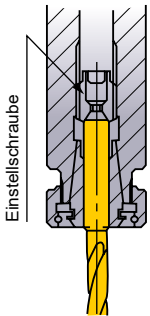

Präzisionsspannzangen können verwendet werden.

**Max. Bohrtiefe**

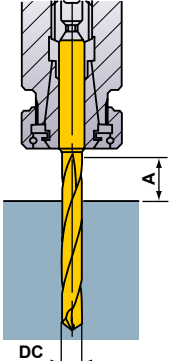

$A \geq DC \times 2.0$

**Bohrer-Einstellung**

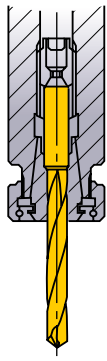

Nicht auf den Nuten spannen.

**Bohrer-Einstellung**

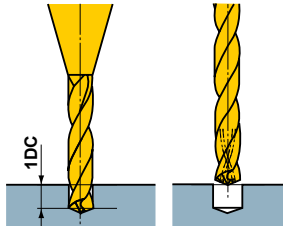

① Für die Pilotbohrung verwenden Sie bitte Bohrer mit SB-Ausführung.  
② Verwenden Sie die Pilotbohrung als Führung. Je nach Schnittdaten empfiehlt es sich mit Vorschubunterbrechung zu arbeiten.

**Interne Kühlmittelzufuhr**

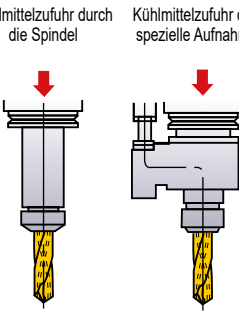

Kühlmittelzufuhr durch die Spindel      Kühlmittelzufuhr durch spezielle Aufnahmen.

Empfohlener Kühlmitteldruck:  
≥ 30 bar  
Mindestens 15 bar erforderlich.

**Dünne Werkstücke**



Stützen Sie das Werkstück. **OK**

Wenn Werkstücke verbiegen... **X**

**Handling mit Kühlmittel**

- 1) Kleine Partikel können die Kühlmittelbohrungen verstopfen. Verwenden Sie daher bitte einen Kühlmittelfilter.
- 2) Stark verschmutztes Kühlmittel reduziert den Spänefluss. Wir empfehlen ein regelmäßiges Wechseln des Kühlmittels. Bitte prüfen Sie eine einwandfreie Kühlmittelzufuhr!

### BENUTZERHINWEIS

- Bitte verwenden Sie einen Kühlmittelfilter ( $\leq 5\mu\text{m}$ ) um Kühlmittelstau zu verhindern.

# MPS1

- Neue PVD-Beschichtung auf AlTiCrN-Basis.
- VHM-Bohrer mit 4 Führungsfasen für hohe Bohrlochqualitäten.



## 4-Fasen & Super Long-VHM-Bohrer



Interne Kühlung



### ● Typ 1 Zylinderschaft mit konischem Hinterschliff

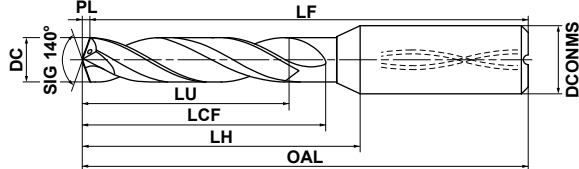

MPS1----S/L-DIN-C/L8C-L40C

### ● Typ 3 Whistle Notch Schaft mit konischem Hinterschliff

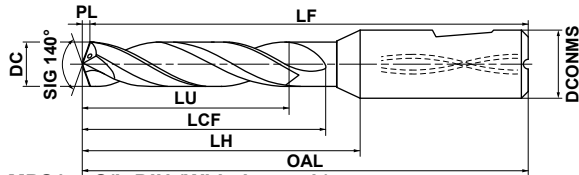

MPS1----S/L-DIN (Whistle notch)



	3 ≤ DC ≤ 6	6 < DC ≤ 10	10 < DC ≤ 18	18 < DC ≤ 20
DIN / PC	+0.010 -0.002	+0.010 -0.005	+0.005 -0.013	+0.005 -0.016
L ___ C	0 -0.012	0 -0.015	0 -0.018	0 -0.021
h6	0 -0.008	0 -0.009	0 -0.011	0 -0.013

\*Die Kühlmittelbohrungen bei Bohren mit Ø4,9 mm oder kleiner haben eine runde Form.  
\*SIG : L/D 3-5 und 10-40=140°, 8=135°, PC = 145°

### ● Typ 2 Zylinderschaft

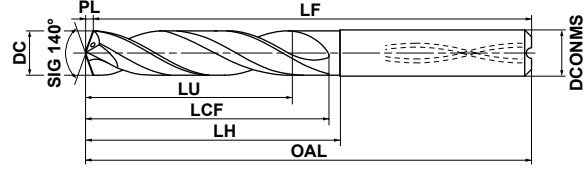

MPS1----S/L-DIN-C/L8C-L40C

### ● Typ 4 Whistle Notch Schaft

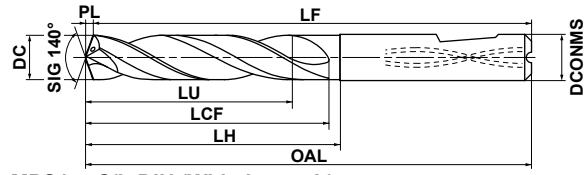

MPS1----S/L-DIN (Whistle notch)

DC (mm)	Bohrtiefe (L/D)	DP1021	Bestellnummer	Abmessungen (mm)							Typ
				LU	LCF	LH	OAL	LF	PL	DCONMS	
3.0	3	□	MPS1-0300S-DIN	15.0	19.5	24.5	61.5	61	0.5	6	3
	3	●	MPS1-0300S-DIN-C	15.0	19.5	24.5	61.5	61	0.5	6	1
	5	□	MPS1-0300L-DIN	20.0	24.5	28.5	65.5	65	0.5	6	3
	5	●	MPS1-0300L-DIN-C	20.0	24.5	28.5	65.5	65	0.5	6	1
	2	●	MPS1-0300-PC	6.5	16.5	19.7	55.5	55	0.5	6	1
	8	●	MPS1-0300-L8C	24.6	33.6	39.6	76.6	76	0.6	6	1
	10	●	MPS1-0300-L10C	30.5	37.5	42.5	79.5	79	0.5	6	1
	12	●	MPS1-0300-L12C	36.5	43.5	48.5	85.5	85	0.5	6	1
	15	●	MPS1-0300-L15C	45.5	52.5	57.5	94.5	94	0.5	6	1
	20	●	MPS1-0300-L20C	60.5	67.5	72.5	109.5	109	0.5	6	1
25	●	MPS1-0300-L25C	75.5	82.5	87.5	124.5	124	0.5	6	1	
30	●	MPS1-0300-L30C	90.5	97.5	102.5	139.5	139	0.5	6	1	
35	□	MPS1-0300-L35C	105.5	113.5	121.5	158.5	158	0.5	6	1	
40	●	MPS1-0300-L40C	120.5	128.5	136.5	173.5	173	0.5	6	1	
3.05	3	□	MPS1-0305S-DIN	15.0	19.6	24.6	61.6	61	0.6	6	3
	3	●	MPS1-0305S-DIN-C	15.0	19.6	24.6	61.6	61	0.6	6	1
	5	□	MPS1-0305L-DIN	20.0	24.6	28.6	65.6	65	0.6	6	3
	5	●	MPS1-0305L-DIN-C	20.0	24.6	28.6	65.6	65	0.6	6	1
3.1	3	□	MPS1-0310S-DIN	14.9	19.6	24.6	61.6	61	0.6	6	3
	3	●	MPS1-0310S-DIN-C	14.9	19.6	24.6	61.6	61	0.6	6	1
	5	□	MPS1-0310L-DIN	19.9	24.6	28.6	65.6	65	0.6	6	3
	5	●	MPS1-0310L-DIN-C	19.9	24.6	28.6	65.6	65	0.6	6	1
	2	●	MPS1-0310-PC	6.7	18.5	21.6	55.5	55	0.5	6	1
	8	●	MPS1-0310-L8C	25.4	39.6	45.6	82.6	82	0.6	6	1
	10	□	MPS1-0310-L10C	31.6	44.6	49.6	86.6	86	0.6	6	1
	12	●	MPS1-0310-L12C	37.8	51.6	56.6	93.6	93	0.6	6	1
	15	●	MPS1-0310-L15C	47.1	61.6	66.6	103.6	103	0.6	6	1
	20	●	MPS1-0310-L20C	62.6	79.6	84.6	121.6	121	0.6	6	1
	25	●	MPS1-0310-L25C	78.1	96.6	101.6	138.6	138	0.6	6	1
	30	●	MPS1-0310-L30C	93.6	114.6	119.6	156.6	156	0.6	6	1
35	□	MPS1-0310-L35C	109.1	123.6	138.6	175.6	175	0.6	6	1	
40	●	MPS1-0310-L40C	124.6	138.6	153.6	190.6	190	0.6	6	1	

DC (mm)	Bohrtiefe (L/D)	DP1021	Bestellnummer	Abmessungen (mm)							Typ
				LU	LCF	LH	OAL	LF	PL	DCONMS	
3.2	3	□	MPS1-0320S-DIN	14.8	19.6	24.6	61.6	61	0.6	6	3
	3	●	MPS1-0320S-DIN-C	14.8	19.6	24.6	61.6	61	0.6	6	1
	5	□	MPS1-0320L-DIN	19.8	24.6	28.6	65.6	65	0.6	6	3
	5	●	MPS1-0320L-DIN-C	19.8	24.6	28.6	65.6	65	0.6	6	1
	2	●	MPS1-0320-PC	6.9	18.5	21.5	55.5	55	0.5	6	1
	8	●	MPS1-0320-L8C	26.3	39.7	45.7	82.7	82	0.7	6	1
	10	□	MPS1-0320-L10C	32.6	44.6	49.6	86.6	86	0.6	6	1
	12	●	MPS1-0320-L12C	39.0	51.6	56.6	93.6	93	0.6	6	1
	15	●	MPS1-0320-L15C	48.6	61.6	66.6	103.6	103	0.6	6	1
	20	●	MPS1-0320-L20C	64.6	79.6	84.6	121.6	121	0.6	6	1
25	●	MPS1-0320-L25C	80.6	96.6	101.6	138.6	138	0.6	6	1	
30	●	MPS1-0320-L30C	96.6	114.6	119.6	156.6	156	0.6	6	1	
35	□	MPS1-0320-L35C	112.6	123.6	138.6	175.6	175	0.6	6	1	
40	●	MPS1-0320-L40C	128.6	138.6	153.6	190.6	190	0.6	6	1	
3.3	3	□	MPS1-0330S-DIN	14.7	19.6	24.6	61.6	61	0.6	6	3
	3	●	MPS1-0330S-DIN-C	14.7	19.6	24.6	61.6	61	0.6	6	1
	5	□	MPS1-0330L-DIN	20.2	25.1	28.6	65.6	65	0.6	6	3
	5	●	MPS1-0330L-DIN-C	20.2	25.1	28.6	65.6	65	0.6	6	1
	2	●	MPS1-0330-PC	7.1	18.5	21.4	55.5	55	0.5	6	1
	8	●	MPS1-0330-L8C	27.1	39.7	45.7	82.7	82	0.7	6	1
	10	□	MPS1-0330-L10C	33.6	44.6	49.6	86.6	86	0.6	6	1
	12	●	MPS1-0330-L12C	40.2	51.6	56.6	93.6	93	0.6	6	1
	15	●	MPS1-0330-L15C	50.1	61.6	66.6	103.6	103	0.6	6	1
	20	●	MPS1-0330-L20C	66.1	79.6	84.6	121.6	121	0.6	6	1
	25	●	MPS1-0330-L25C	83.1	96.6	101.6	138.6	138	0.6	6	1
	30	●	MPS1-0330-L30C	99.6	114.6	119.6	156.6	156	0.6	6	1
35	□	MPS1-0330-L35C	116.1	132.6	138.6	175.6	175	0.6	6	1	
40	●	MPS1-0330-L40C	132.6	148.6	153.6	190.6	190	0.6	6	1	

● : Lagerstandard. □ : Herstellung nur auf Anfrage.

SCHNITTBEDINGUNGEN > M072  
ANWENDUNGSHINWEISE > M073  
TECHNISCHE DATEN > P001

# BOHREN (VOLLHARTMETALL)

## MPS1

4-Fasen & Super Long-VHM-Bohrer

HARTMETALL

M  
BOHREN

DC	Bohrtiefe (mm)	Bohrtiefe (L/D)	DP1021	Bestellnummer	Abmessungen (mm)							Typ
					LU	LCF	LH	OAL	LF	PL	DCONMS	
3.4	3	□		MPS1-0340S-DIN	14.5	19.6	24.6	61.6	61	0.6	6	3
	3	●		MPS1-0340S-DIN-C	14.5	19.6	24.6	61.6	61	0.6	6	1
	5	□		MPS1-0340L-DIN	20.0	25.1	28.6	65.6	65	0.6	6	3
	5	●		MPS1-0340L-DIN-C	20.0	25.1	28.6	65.6	65	0.6	6	1
	2	●		MPS1-0340-PC	7.3	18.5	21.3	55.5	55	0.5	6	1
	8	●		MPS1-0340-L8C	27.9	39.7	45.7	82.7	82	0.7	6	1
	10	□		MPS1-0340-L10C	34.6	44.6	49.6	86.6	86	0.6	6	1
	12	●		MPS1-0340-L12C	41.4	51.6	56.6	93.6	93	0.6	6	1
	15	●		MPS1-0340-L15C	51.6	61.6	66.6	103.6	103	0.6	6	1
	20	●		MPS1-0340-L20C	68.6	79.6	84.6	121.6	121	0.6	6	1
	25	●		MPS1-0340-L25C	85.6	96.6	101.6	138.6	138	0.6	6	1
	30	●		MPS1-0340-L30C	102.6	114.6	119.6	156.6	156	0.6	6	1
35	□		MPS1-0340-L35C	119.6	132.6	138.6	175.6	175	0.6	6	1	
40	●		MPS1-0340-L40C	136.6	148.6	153.6	190.6	190	0.6	6	1	
3.5	3	□		MPS1-0350S-DIN	14.4	19.6	24.6	61.6	61	0.6	6	3
	3	●		MPS1-0350S-DIN-C	14.4	19.6	24.6	61.6	61	0.6	6	1
	5	□		MPS1-0350L-DIN	19.9	25.1	28.6	65.6	65	0.6	6	3
	5	●		MPS1-0350L-DIN-C	19.9	25.1	28.6	65.6	65	0.6	6	1
	2	●		MPS1-0350-PC	7.6	18.6	21.2	55.6	55	0.6	6	1
	8	●		MPS1-0350-L8C	28.7	39.7	45.7	82.7	82	0.7	6	1
	10	□		MPS1-0350-L10C	35.6	44.6	49.6	86.6	86	0.6	6	1
	12	●		MPS1-0350-L12C	42.6	51.6	56.6	93.6	93	0.6	6	1
	15	●		MPS1-0350-L15C	53.1	61.6	66.6	103.6	103	0.6	6	1
	20	●		MPS1-0350-L20C	70.6	79.6	84.6	121.6	121	0.6	6	1
	25	●		MPS1-0350-L25C	88.1	96.6	101.6	138.6	138	0.6	6	1
	30	●		MPS1-0350-L30C	105.6	114.6	119.6	156.6	156	0.6	6	1
35	□		MPS1-0350-L35C	123.1	132.6	138.6	175.6	175	0.6	6	1	
40	●		MPS1-0350-L40C	140.6	148.6	153.6	190.6	190	0.6	6	1	
3.6	3	□		MPS1-0360S-DIN	14.3	19.7	24.7	61.7	61	0.7	6	3
	3	●		MPS1-0360S-DIN-C	14.3	19.7	24.7	61.7	61	0.7	6	1
	5	□		MPS1-0360L-DIN	19.8	25.2	28.7	65.7	65	0.7	6	3
	5	●		MPS1-0360L-DIN-C	19.8	25.2	28.7	65.7	65	0.7	6	1
	2	●		MPS1-0360-PC	7.8	20.6	23.1	55.6	55	0.6	6	1
	8	●		MPS1-0360-L8C	29.5	44.7	50.7	87.7	87	0.7	6	1
	10	□		MPS1-0360-L10C	36.7	50.7	55.7	92.7	92	0.7	6	1
	12	●		MPS1-0360-L12C	43.9	58.7	63.7	100.7	100	0.7	6	1
	15	●		MPS1-0360-L15C	54.7	70.7	75.7	112.7	112	0.7	6	1
	20	●		MPS1-0360-L20C	72.7	90.7	95.7	132.7	132	0.7	6	1
	25	□		MPS1-0360-L25C	90.7	110.7	115.7	152.7	152	0.7	6	1
	30	●		MPS1-0360-L30C	108.7	130.7	135.7	172.7	172	0.7	6	1
35	□		MPS1-0360-L35C	126.7	143.7	155.7	192.7	192	0.7	6	1	
40	●		MPS1-0360-L40C	144.7	160.7	175.7	212.7	212	0.7	6	1	
3.7	3	□		MPS1-0370S-DIN	14.1	19.7	24.7	61.7	61	0.7	6	3
	3	●		MPS1-0370S-DIN-C	14.1	19.7	24.7	61.7	61	0.7	6	1
	5	□		MPS1-0370L-DIN	20.1	25.7	28.7	65.7	65	0.7	6	3
	5	●		MPS1-0370L-DIN-C	20.1	25.7	28.7	65.7	65	0.7	6	1
	2	●		MPS1-0370-PC	8.0	20.6	23.1	55.6	55	0.6	6	1
	8	●		MPS1-0370-L8C	30.4	44.8	50.8	87.8	87	0.8	6	1
	10	□		MPS1-0370-L10C	37.7	50.7	55.7	92.7	92	0.7	6	1
	12	●		MPS1-0370-L12C	45.1	58.7	63.7	100.7	100	0.7	6	1
	15	●		MPS1-0370-L15C	56.2	70.7	75.7	112.7	112	0.7	6	1
	20	●		MPS1-0370-L20C	74.7	90.7	95.7	132.7	132	0.7	6	1
	25	●		MPS1-0370-L25C	93.2	110.7	115.7	152.7	152	0.7	6	1
	30	●		MPS1-0370-L30C	111.7	130.7	135.7	172.7	172	0.7	6	1
35	□		MPS1-0370-L35C	130.2	143.7	155.7	192.7	192	0.7	6	1	
40	●		MPS1-0370-L40C	148.7	160.7	175.7	212.7	212	0.7	6	1	

DC	Bohrtiefe (mm)	Bohrtiefe (L/D)	DP1021	Bestellnummer	Abmessungen (mm)							Typ
					LU	LCF	LH	OAL	LF	PL	DCONMS	
3.8	3	□		MPS1-0380S-DIN	18.0	23.7	28.7	65.7	65	0.7	6	3
	3	●		MPS1-0380S-DIN-C	18.0	23.7	28.7	65.7	65	0.7	6	1
	5	□		MPS1-0380L-DIN	28.0	33.7	36.7	73.7	73	0.7	6	3
	5	●		MPS1-0380L-DIN-C	28.0	33.7	36.7	73.7	73	0.7	6	1
	2	●		MPS1-0380-PC	8.2	20.6	23.0	55.6	55	0.6	6	1
	8	●		MPS1-0380-L8C	31.2	44.8	50.8	87.8	87	0.8	6	1
	10	□		MPS1-0380-L10C	38.7	50.7	55.7	92.7	92	0.7	6	1
	12	●		MPS1-0380-L12C	46.3	58.7	63.7	100.7	100	0.7	6	1
	15	●		MPS1-0380-L15C	57.7	70.7	75.7	112.7	112	0.7	6	1
	20	●		MPS1-0380-L20C	76.7	90.7	95.7	132.7	132	0.7	6	1
	25	●		MPS1-0380-L25C	95.7	110.7	115.7	152.7	152	0.7	6	1
	30	●		MPS1-0380-L30C	114.7	130.7	135.7	172.7	172	0.7	6	1
35	□		MPS1-0380-L35C	133.7	150.7	155.7	192.7	192	0.7	6	1	
40	●		MPS1-0380-L40C	152.7	170.7	175.7	212.7	212	0.7	6	1	
3.9	3	□		MPS1-0390S-DIN	17.9	23.7	28.7	65.7	65	0.7	6	3
	3	●		MPS1-0390S-DIN-C	17.9	23.7	28.7	65.7	65	0.7	6	1
	5	□		MPS1-0390L-DIN	27.9	33.7	36.7	73.7	73	0.7	6	3
	5	●		MPS1-0390L-DIN-C	27.9	33.7	36.7	73.7	73	0.7	6	1
	2	●		MPS1-0390-PC	8.4	20.6	22.9	55.6	55	0.6	6	1
	8	●		MPS1-0390-L8C	32.0	44.8	50.8	87.8	87	0.8	6	1
	10	□		MPS1-0390-L10C	39.7	50.7	55.7	92.7	92	0.7	6	1
	12	●		MPS1-0390-L12C	47.5	58.7	63.7	100.7	100	0.7	6	1
	15	●		MPS1-0390-L15C	59.2	70.7	75.7	112.7	112	0.7	6	1
	20	●		MPS1-0390-L20C	78.7	90.7	95.7	132.7	132	0.7	6	1
	25	□		MPS1-0390-L25C	98.2	110.7	115.7	152.7	152	0.7	6	1
	30	●		MPS1-0390-L30C	117.7	130.7	135.7	172.7	172	0.7	6	1
35	□		MPS1-0390-L35C	137.2	150.7	155.7	192.7	192	0.7	6	1	
40	●		MPS1-0390-L40C	156.7	170.7	175.7	212.7	212	0.7	6	1	
4.0	3	□		MPS1-0400S-DIN	17.7	23.7	28.7	65.7	65	0.7	6	3
	3	●		MPS1-0400S-DIN-C	17.7	23.7	28.7	65.7	65	0.7	6	1
	5	□		MPS1-0400L-DIN	27.7	33.7	36.7	73.7	73	0.7	6	3
	5	●		MPS1-0400L-DIN-C	27.7	33.7	36.7	73.7	73	0.7	6	1
	2	●		MPS1-0400-PC	8.6	20.6	22.8	55.6	55	0.6	6	1
	8	●		MPS1-0400-L8C	32.8	44.8	50.8	87.8	87	0.8	6	1
	10	□		MPS1-0400-L10C	40.7	50.7	55.7	92.7	92	0.7	6	1
	12	●		MPS1-0400-L12C	48.7	58.7	63.7	100.7	100	0.7	6	1
	15	●		MPS1-0400-L15C	60.7	70.7	75.7	112.7	112	0.7	6	1
	20	●		MPS1-0400-L20C	80.7	90.7	95.7	132.7	132	0.7	6	1
	25	●		MPS1-0400-L25C	100.7	110.7	115.7	152.7	152	0.7	6	1
	30	●		MPS1-0400-L30C	120.7	130.7	135.7	172.7	172	0.7	6	1
35	□		MPS1-0400-L35C	140.7	150.7	155.7	192.7	192	0.7	6	1	
40	●		MPS1-0400-L40C	160.7	170.7	175.7	212.7	212	0.7	6	1	
4.05	3	□		MPS1-0405S-DIN	17.7	23.7	28.7	65.7	65	0.7	6	3
	3	●		MPS1-0405S-DIN-C	17.7	23.7	28.7	65.7	65	0.7	6	1
	5	□		MPS1-0405L-DIN	27.7	33.7	36.7	73.7	73	0.7	6	3
	5	●		MPS1-0405L-DIN-C	27.7	33.7	36.7	73.7	73	0.7	6	1

● : Lagerstandard. □ : Herstellung nur auf Anfrage.



DC	Bohrtiefe (mm)	Bohrtiefe (L/D)	DP1021	Bestellnummer	Abmessungen (mm)							Typ
					LU	LCF	LH	OAL	LF	PL	DCONMS	
4.1	3	□		MPS1-0410S-DIN	17.6	23.7	28.7	65.7	65	0.7	6	3
	3	●		MPS1-0410S-DIN-C	17.6	23.7	28.7	65.7	65	0.7	6	1
	5	□		MPS1-0410L-DIN	27.6	33.7	36.7	73.7	73	0.7	6	3
	5	●		MPS1-0410L-DIN-C	27.6	33.7	36.7	73.7	73	0.7	6	1
	2	●		MPS1-0410-PC	8.8	22.6	24.7	62.6	62	0.6	6	1
	8	●		MPS1-0410-L8C	33.6	50.8	55.8	92.8	92	0.8	6	1
	10	□		MPS1-0410-L10C	41.7	58.7	62.7	99.7	99	0.7	6	1
	12	●		MPS1-0410-L12C	49.9	67.7	71.7	108.7	108	0.7	6	1
	15	●		MPS1-0410-L15C	62.2	80.7	84.7	121.7	121	0.7	6	1
	20	●		MPS1-0410-L20C	82.7	103.7	107.7	144.7	144	0.7	6	1
	25	●		MPS1-0410-L25C	103.2	125.7	129.7	166.7	166	0.7	6	1
	30	●		MPS1-0410-L30C	123.7	148.7	152.7	189.7	189	0.7	6	1
	35	□		MPS1-0410-L35C	144.2	164.7	174.7	211.7	211	0.7	6	1
	40	●		MPS1-0410-L40C	164.7	184.7	198.7	235.7	235	0.7	6	1
4.2	3	□		MPS1-0420S-DIN	17.5	23.8	28.8	65.8	65	0.8	6	3
	3	●		MPS1-0420S-DIN-C	17.5	23.8	28.8	65.8	65	0.8	6	1
	5	□		MPS1-0420L-DIN	28.0	34.3	36.8	73.8	73	0.8	6	3
	5	●		MPS1-0420L-DIN-C	28.0	34.3	36.8	73.8	73	0.8	6	1
	2	●		MPS1-0420-PC	9.1	22.7	24.6	62.7	62	0.7	6	1
	8	●		MPS1-0420-L8C	34.5	50.9	55.9	92.9	92	0.9	6	1
	10	□		MPS1-0420-L10C	42.8	58.8	62.8	99.8	99	0.8	6	1
	12	●		MPS1-0420-L12C	51.2	67.8	71.8	108.8	108	0.8	6	1
	15	●		MPS1-0420-L15C	63.8	80.8	84.8	121.8	121	0.8	6	1
	20	●		MPS1-0420-L20C	84.8	103.8	107.8	144.8	144	0.8	6	1
	25	●		MPS1-0420-L25C	105.8	125.8	129.8	166.8	166	0.8	6	1
30	●		MPS1-0420-L30C	126.8	148.8	152.8	189.8	189	0.8	6	1	
35	●		MPS1-0420-L35C	147.8	164.8	174.8	211.8	211	0.8	6	1	
40	●		MPS1-0420-L40C	168.8	184.8	198.8	235.8	235	0.8	6	1	
4.3	3	□		MPS1-0430S-DIN	17.3	23.8	28.8	65.8	65	0.8	6	3
	3	●		MPS1-0430S-DIN-C	17.3	23.8	28.8	65.8	65	0.8	6	1
	5	□		MPS1-0430L-DIN	27.8	34.3	36.8	73.8	73	0.8	6	3
	5	●		MPS1-0430L-DIN-C	27.8	34.3	36.8	73.8	73	0.8	6	1
	2	●		MPS1-0430-PC	9.3	22.7	24.5	62.7	62	0.7	6	1
	8	●		MPS1-0430-L8C	35.3	50.9	55.9	92.9	92	0.9	6	1
	10	□		MPS1-0430-L10C	43.8	58.8	62.8	99.8	99	0.8	6	1
	12	●		MPS1-0430-L12C	52.4	67.8	71.8	108.8	108	0.8	6	1
	15	●		MPS1-0430-L15C	65.3	80.8	84.8	121.8	121	0.8	6	1
	20	●		MPS1-0430-L20C	86.8	103.8	107.8	144.8	144	0.8	6	1
	25	●		MPS1-0430-L25C	108.3	125.8	129.8	166.8	166	0.8	6	1
30	●		MPS1-0430-L30C	129.8	148.8	152.8	189.8	189	0.8	6	1	
35	□		MPS1-0430-L35C	151.3	170.8	174.8	211.8	211	0.8	6	1	
40	●		MPS1-0430-L40C	172.8	194.8	198.8	235.8	235	0.8	6	1	
4.4	3	□		MPS1-0440S-DIN	17.2	23.8	28.8	65.8	65	0.8	6	3
	3	●		MPS1-0440S-DIN-C	17.2	23.8	28.8	65.8	65	0.8	6	1
	5	□		MPS1-0440L-DIN	27.7	34.3	36.8	73.8	73	0.8	6	3
	5	●		MPS1-0440L-DIN-C	27.7	34.3	36.8	73.8	73	0.8	6	1
	2	●		MPS1-0440-PC	9.5	22.7	24.4	62.7	62	0.7	6	1
	8	●		MPS1-0440-L8C	36.1	50.9	55.9	92.9	92	0.9	6	1
	10	□		MPS1-0440-L10C	44.8	58.8	62.8	99.8	99	0.8	6	1
	12	●		MPS1-0440-L12C	53.6	67.8	71.8	108.8	108	0.8	6	1
	15	●		MPS1-0440-L15C	66.8	80.8	84.8	121.8	121	0.8	6	1
	20	□		MPS1-0440-L20C	88.8	103.8	107.8	144.8	144	0.8	6	1
	25	□		MPS1-0440-L25C	110.8	125.8	129.8	166.8	166	0.8	6	1
30	□		MPS1-0440-L30C	132.8	148.8	152.8	189.8	189	0.8	6	1	
35	□		MPS1-0440-L35C	154.8	170.8	174.8	211.8	211	0.8	6	1	
40	●		MPS1-0440-L40C	176.8	194.8	198.8	235.8	235	0.8	6	1	

DC	Bohrtiefe (mm)	Bohrtiefe (L/D)	DP1021	Bestellnummer	Abmessungen (mm)							Typ
					LU	LCF	LH	OAL	LF	PL	DCONMS	
4.5	3	□		MPS1-0450S-DIN	17.1	23.8	28.8	65.8	65	0.8	6	3
	3	●		MPS1-0450S-DIN-C	17.1	23.8	28.8	65.8	65	0.8	6	1
	5	□		MPS1-0450L-DIN	27.6	34.3	36.8	73.8	73	0.8	6	3
	5	●		MPS1-0450L-DIN-C	27.6	34.3	36.8	73.8	73	0.8	6	1
	2	●		MPS1-0450-PC	9.7	22.7	24.3	62.7	62	0.7	6	1
	8	●		MPS1-0450-L8C	36.9	50.9	55.9	92.9	92	0.9	6	1
	10	□		MPS1-0450-L10C	45.8	58.8	62.8	99.8	99	0.8	6	1
	12	●		MPS1-0450-L12C	54.8	67.8	71.8	108.8	108	0.8	6	1
	15	●		MPS1-0450-L15C	68.3	80.8	84.8	121.8	121	0.8	6	1
	20	●		MPS1-0450-L20C	90.8	103.8	107.8	144.8	144	0.8	6	1
	25	●		MPS1-0450-L25C	113.3	125.8	129.8	166.8	166	0.8	6	1
30	●		MPS1-0450-L30C	135.8	148.8	152.8	189.8	189	0.8	6	1	
35	□		MPS1-0450-L35C	158.3	170.8	174.8	211.8	211	0.8	6	1	
40	●		MPS1-0450-L40C	180.8	194.8	198.8	235.8	235	0.8	6	1	
4.6	3	□		MPS1-0460S-DIN	16.9	23.8	28.8	65.8	65	0.8	6	4
	3	●		MPS1-0460S-DIN-C	16.9	23.8	28.8	65.8	65	0.8	6	2
	5	□		MPS1-0460L-DIN	28.9	35.8	36.8	73.8	73	0.8	6	4
	5	●		MPS1-0460L-DIN-C	28.9	35.8	36.8	73.8	73	0.8	6	2
	2	●		MPS1-0460-PC	9.9	24.7	27.7	62.7	62	0.7	6	2
	8	●		MPS1-0460-L8C	37.8	56.0	59.0	96.0	95	1.0	6	2
	10	□		MPS1-0460-L10C	46.8	65.8	68.8	105.8	105	0.8	6	2
	12	●		MPS1-0460-L12C	56.0	75.8	78.8	115.8	115	0.8	6	2
	15	●		MPS1-0460-L15C	69.8	90.8	93.8	130.8	130	0.8	6	2
	20	●		MPS1-0460-L20C	92.8	115.8	118.8	155.8	155	0.8	6	2
	25	●		MPS1-0460-L25C	115.8	140.8	143.8	180.8	180	0.8	6	2
30	●		MPS1-0460-L30C	138.8	165.8	168.8	205.8	205	0.8	6	2	
35	□		MPS1-0460-L35C	161.8	184.8	192.8	229.8	229	0.8	6	2	
40	●		MPS1-0460-L40C	184.8	204.8	217.8	254.8	254	0.8	6	2	
4.65	3	□		MPS1-0465S-DIN	16.9	23.8	28.8	65.8	65	0.8	6	4
	3	●		MPS1-0465S-DIN-C	16.9	23.8	28.8	65.8	65	0.8	6	2
	5	□		MPS1-0465L-DIN	28.9	35.8	36.8	73.8	73	0.8	6	4
	5	●		MPS1-0465L-DIN-C	28.9	35.8	36.8	73.8	73	0.8	6	2
4.7	3	□		MPS1-0470S-DIN	16.8	23.9	28.9	65.9	65	0.9	6	4
	3	●		MPS1-0470S-DIN-C	16.8	23.9	28.9	65.9	65	0.9	6	2
	5	□		MPS1-0470L-DIN	28.8	35.9	36.9	73.9	73	0.9	6	4
	5	●		MPS1-0470L-DIN-C	28.8	35.9	36.9	73.9	73	0.9	6	2
	2	●		MPS1-0470-PC	10.1	24.7	27.7	62.7	62	0.7	6	2
	8	●		MPS1-0470-L8C	38.6	56.0	59.0	96.0	95	1.0	6	2
	10	□		MPS1-0470-L10C	47.9	65.9	68.9	105.9	105	0.9	6	2
	12	●		MPS1-0470-L12C	57.3	75.9	78.9	115.9	115	0.9	6	2
	15	●		MPS1-0470-L15C	71.4	90.9	93.9	130.9	130	0.9	6	2
	20	●		MPS1-0470-L20C	94.9	115.9	118.9	155.9	155	0.9	6	2
	25	●		MPS1-0470-L25C	118.4	140.9	143.9	180.9	180	0.9	6	2
30	●		MPS1-0470-L30C	141.9	165.9	168.9	205.9	205	0.9	6	2	
35	□		MPS1-0470-L35C	165.4	184.9	192.9	229.9	229	0.9	6	2	
40	●		MPS1-0470-L40C	188.9	204.9	217.9	254.9	254	0.9	6	2	

M

BOHREN

# BOHREN (VOLLHARTMETALL)

## MPS1

4-Fasen & Super Long-VHM-Bohrer

HARTMETALL

M  
BOHREN

DC	Bohrtiefe (mm)	Bohrtiefe (L/D)	DP1021	Bestellnummer	Abmessungen (mm)							Typ
					LU	LCF	LH	OAL	LF	PL	DCONMS	
4.8	3	□		MPS1-0480S-DIN	20.7	27.9	28.9	65.9	65	0.9	6	4
	3	●		MPS1-0480S-DIN-C	20.7	27.9	28.9	65.9	65	0.9	6	2
	5	□		MPS1-0480L-DIN	36.7	43.9	44.9	81.9	81	0.9	6	4
	5	●		MPS1-0480L-DIN-C	36.7	43.9	44.9	81.9	81	0.9	6	2
	2	●		MPS1-0480-PC	10.4	24.8	27.8	62.8	62	0.8	6	2
	8	●		MPS1-0480-L8C	39.4	56.0	59.0	96.0	95	1.0	6	2
	10	□		MPS1-0480-L10C	48.9	65.9	68.9	105.9	105	0.9	6	2
	12	●		MPS1-0480-L12C	58.5	75.9	78.9	115.9	115	0.9	6	2
	15	●		MPS1-0480-L15C	72.9	90.9	93.9	130.9	130	0.9	6	2
	20	●		MPS1-0480-L20C	96.9	115.9	118.9	155.9	155	0.9	6	2
	25	●		MPS1-0480-L25C	120.9	140.9	143.9	180.9	180	0.9	6	2
	30	●		MPS1-0480-L30C	144.9	165.9	168.9	205.9	205	0.9	6	2
35	□		MPS1-0480-L35C	168.9	190.9	192.9	229.9	229	0.9	6	2	
40	●		MPS1-0480-L40C	192.9	215.9	217.9	254.9	254	0.9	6	2	
4.9	3	□		MPS1-0490S-DIN	20.5	27.9	28.9	65.9	65	0.9	6	4
	3	●		MPS1-0490S-DIN-C	20.5	27.9	28.9	65.9	65	0.9	6	2
	5	□		MPS1-0490L-DIN	36.5	43.9	44.9	81.9	81	0.9	6	4
	5	●		MPS1-0490L-DIN-C	36.5	43.9	44.9	81.9	81	0.9	6	2
	2	●		MPS1-0490-PC	10.6	24.8	27.8	62.8	62	0.8	6	2
	8	●		MPS1-0490-L8C	40.2	56.0	59.0	96.0	95	1.0	6	2
	10	□		MPS1-0490-L10C	49.9	65.9	68.9	105.9	105	0.9	6	2
	12	●		MPS1-0490-L12C	59.7	75.9	78.9	115.9	115	0.9	6	2
	15	●		MPS1-0490-L15C	74.4	90.9	93.9	130.9	130	0.9	6	2
	20	□		MPS1-0490-L20C	98.9	115.9	118.9	155.9	155	0.9	6	2
	25	●		MPS1-0490-L25C	123.4	140.9	143.9	180.9	180	0.9	6	2
	30	●		MPS1-0490-L30C	147.9	165.9	168.9	205.9	205	0.9	6	2
35	□		MPS1-0490-L35C	172.4	190.9	192.9	229.9	229	0.9	6	2	
40	●		MPS1-0490-L40C	196.9	215.9	217.9	254.9	254	0.9	6	2	
5.0	3	□		MPS1-0500S-DIN	20.4	27.9	28.9	65.9	65	0.9	6	4
	3	●		MPS1-0500S-DIN-C	20.4	27.9	28.9	65.9	65	0.9	6	2
	5	□		MPS1-0500L-DIN	36.4	43.9	44.9	81.9	81	0.9	6	4
	5	●		MPS1-0500L-DIN-C	36.4	43.9	44.9	81.9	81	0.9	6	2
	2	●		MPS1-0500-PC	10.8	24.8	25.8	62.8	62	0.8	6	2
	8	●		MPS1-0500-L8C	41.0	56.0	59.0	96.0	95	1.0	6	2
	10	□		MPS1-0500-L10C	50.9	65.9	68.9	105.9	105	0.9	6	2
	12	●		MPS1-0500-L12C	60.9	75.9	78.9	115.9	115	0.9	6	2
	15	●		MPS1-0500-L15C	75.9	90.9	93.9	130.9	130	0.9	6	2
	20	●		MPS1-0500-L20C	100.9	115.9	118.9	155.9	155	0.9	6	2
	25	●		MPS1-0500-L25C	125.9	140.9	143.9	180.9	180	0.9	6	2
	30	●		MPS1-0500-L30C	150.9	165.9	168.9	205.9	205	0.9	6	2
35	□		MPS1-0500-L35C	175.9	190.9	192.9	229.9	229	0.9	6	2	
40	●		MPS1-0500-L40C	200.9	215.9	217.9	254.9	254	0.9	6	2	
5.05	3	□		MPS1-0505S-DIN	20.3	27.9	28.9	65.9	65	0.9	6	4
	3	●		MPS1-0505S-DIN-C	20.3	27.9	28.9	65.9	65	0.9	6	2
	5	□		MPS1-0505L-DIN	36.3	43.9	44.9	81.9	81	0.9	6	4
	5	●		MPS1-0505L-DIN-C	36.3	43.9	44.9	81.9	81	0.9	6	2

DC	Bohrtiefe (mm)	Bohrtiefe (L/D)	DP1021	Bestellnummer	Abmessungen (mm)							Typ
					LU	LCF	LH	OAL	LF	PL	DCONMS	
5.1	3	□		MPS1-0510S-DIN	20.3	27.9	28.9	65.9	65	0.9	6	4
	3	●		MPS1-0510S-DIN-C	20.3	27.9	28.9	65.9	65	0.9	6	2
	5	□		MPS1-0510L-DIN	36.3	43.9	44.9	81.9	81	0.9	6	4
	5	●		MPS1-0510L-DIN-C	36.3	43.9	44.9	81.9	81	0.9	6	2
	2	●		MPS1-0510-PC	11.0	26.8	28.8	66.8	66	0.8	6	2
	8	●		MPS1-0510-L8C	41.9	62.1	65.1	102.1	101	1.1	6	2
	10	□		MPS1-0510-L10C	51.9	72.9	75.9	112.9	112	0.9	6	2
	12	●		MPS1-0510-L12C	62.1	83.9	86.9	123.9	123	0.9	6	2
	15	●		MPS1-0510-L15C	77.4	99.9	102.9	139.9	139	0.9	6	2
	20	●		MPS1-0510-L20C	102.9	127.9	130.9	167.9	167	0.9	6	2
	25	●		MPS1-0510-L25C	128.4	154.9	157.9	194.9	194	0.9	6	2
	30	●		MPS1-0510-L30C	153.9	182.9	185.9	222.9	222	0.9	6	2
35	□		MPS1-0510-L35C	179.4	203.9	211.9	248.9	248	0.9	6	2	
40	●		MPS1-0510-L40C	204.9	230.9	241.9	278.9	278	0.9	6	2	
5.2	3	□		MPS1-0520S-DIN	20.1	27.9	28.9	65.9	65	0.9	6	4
	3	●		MPS1-0520S-DIN-C	20.1	27.9	28.9	65.9	65	0.9	6	2
	5	□		MPS1-0520L-DIN	36.1	43.9	44.9	81.9	81	0.9	6	4
	5	●		MPS1-0520L-DIN-C	36.1	43.9	44.9	81.9	81	0.9	6	2
	2	●		MPS1-0520-PC	11.2	26.8	28.8	66.8	66	0.8	6	2
	8	●		MPS1-0520-L8C	42.7	62.1	65.1	102.1	101	1.1	6	2
	10	□		MPS1-0520-L10C	52.9	72.9	75.9	112.9	112	0.9	6	2
	12	●		MPS1-0520-L12C	63.3	83.9	86.9	123.9	123	0.9	6	2
	15	●		MPS1-0520-L15C	78.9	99.9	102.9	139.9	139	0.9	6	2
	20	●		MPS1-0520-L20C	104.9	127.9	130.9	167.9	167	0.9	6	2
	25	●		MPS1-0520-L25C	130.9	154.9	157.9	194.9	194	0.9	6	2
	30	●		MPS1-0520-L30C	156.9	182.9	185.9	222.9	222	0.9	6	2
35	□		MPS1-0520-L35C	182.9	203.9	211.9	248.9	248	0.9	6	2	
40	●		MPS1-0520-L40C	208.9	230.9	241.9	278.9	278	0.9	6	2	
5.3	3	□		MPS1-0530S-DIN	20.0	28.0	29.0	66.0	65	1.0	6	4
	3	●		MPS1-0530S-DIN-C	20.0	28.0	29.0	66.0	65	1.0	6	2
	5	□		MPS1-0530L-DIN	36.0	44.0	45.0	82.0	81	1.0	6	4
	5	●		MPS1-0530L-DIN-C	36.0	44.0	45.0	82.0	81	1.0	6	2
	2	●		MPS1-0530-PC	11.4	26.8	28.8	66.8	66	0.8	6	2
	8	●		MPS1-0530-L8C	43.5	62.1	65.1	102.1	101	1.1	6	2
	10	□		MPS1-0530-L10C	54.0	73.0	76.0	113.0	112	1.0	6	2
	12	●		MPS1-0530-L12C	64.6	84.0	87.0	124.0	123	1.0	6	2
	15	●		MPS1-0530-L15C	80.5	100.0	103.0	140.0	139	1.0	6	2
	20	□		MPS1-0530-L20C	107.0	128.0	131.0	168.0	167	1.0	6	2
	25	●		MPS1-0530-L25C	133.5	155.0	158.0	195.0	194	1.0	6	2
	30	●		MPS1-0530-L30C	160.0	183.0	186.0	223.0	222	1.0	6	2
35	□		MPS1-0530-L35C	186.5	210.0	212.0	249.0	248	1.0	6	2	
40	●		MPS1-0530-L40C	213.0	241.0	242.0	279.0	278	1.0	6	2	
5.4	3	□		MPS1-0540S-DIN	19.9	28.0	29.0	66.0	65	1.0	6	2
	3	●		MPS1-0540S-DIN-C	19.9	28.0	29.0	66.0	65	1.0	6	4
	5	□		MPS1-0540L-DIN	35.9	44.0	45.0	82.0	81	1.0	6	4
	5	●		MPS1-0540L-DIN-C	35.9	44.0	45.0	82.0	81	1.0	6	2
	2	●		MPS1-0540-PC	11.7	26.9	28.9	66.9	66	0.9	6	2
	8	●		MPS1-0540-L8C	44.3	62.1	65.1	102.1	101	1.1	6	2
	10	□		MPS1-0540-L10C	55.0	73.0	76.0	113.0	112	1.0	6	2
	12	●		MPS1-0540-L12C	65.8	84.0	87.0	124.0	123	1.0	6	2
	15	●		MPS1-0540-L15C	82.0	100.0	103.0	140.0	139	1.0	6	2
	20	●		MPS1-0540-L20C	109.0	128.0	131.0	168.0	167	1.0	6	2
	25	□		MPS1-0540-L25C	136.0	155.0	158.0	195.0	194	1.0	6	2
	30	□		MPS1-0540-L30C	163.0	183.0	186.0	223.0	222	1.0	6	2
35	□		MPS1-0540-L35C	190.0	210.0	212.0	249.0	248	1.0	6	2	
40	●		MPS1-0540-L40C	217.0	241.0	242.0	279.0	278	1.0	6	2	

● : Lagerstandard. □ : Herstellung nur auf Anfrage.

DC	Bohrtiefe (mm)	Bohrtiefe (L/D)	DP1021	Bestellnummer	Abmessungen (mm)							Typ
					LU	LCF	LH	OAL	LF	PL	DCONMS	
5.5	3	□		MPS1-0550S-DIN	19.8	28.0	29.0	66.0	65	1.0	6	4
	3	●		MPS1-0550S-DIN-C	19.8	28.0	29.0	66.0	65	1.0	6	2
	5	□		MPS1-0550L-DIN	35.8	44.0	45.0	82.0	81	1.0	6	4
	5	●		MPS1-0550L-DIN-C	35.8	44.0	45.0	82.0	81	1.0	6	2
	2	●		MPS1-0550-PC	11.9	26.9	28.9	66.9	66	0.9	6	2
	8	●		MPS1-0550-L8C	45.1	62.1	65.1	102.1	101	1.1	6	2
	10	□		MPS1-0550-L10C	56.0	73.0	76.0	113.0	112	1.0	6	2
	12	●		MPS1-0550-L12C	67.0	84.0	87.0	124.0	123	1.0	6	2
	15	●		MPS1-0550-L15C	83.5	100.0	103.0	140.0	139	1.0	6	2
	20	●		MPS1-0550-L20C	111.0	128.0	131.0	168.0	167	1.0	6	2
	25	●		MPS1-0550-L25C	138.5	155.0	158.0	195.0	194	1.0	6	2
	30	●		MPS1-0550-L30C	166.0	183.0	186.0	223.0	222	1.0	6	2
35	□		MPS1-0550-L35C	193.5	210.0	212.0	249.0	248	1.0	6	2	
40	●		MPS1-0550-L40C	221.0	241.0	242.0	279.0	278	1.0	6	2	
5.55	3	□		MPS1-0555S-DIN	19.7	28.0	29.0	66.0	65	1.0	6	4
	3	●		MPS1-0555S-DIN-C	19.7	28.0	29.0	66.0	65	1.0	6	2
	5	□		MPS1-0555L-DIN	35.7	44.0	45.0	82.0	81	1.0	6	4
	5	●		MPS1-0555L-DIN-C	35.7	44.0	45.0	82.0	81	1.0	6	2
5.6	3	□		MPS1-0560S-DIN	19.6	28.0	29.0	66.0	65	1.0	6	4
	3	●		MPS1-0560S-DIN-C	19.6	28.0	29.0	66.0	65	1.0	6	2
	5	□		MPS1-0560L-DIN	35.6	44.0	45.0	82.0	81	1.0	6	4
	5	●		MPS1-0560L-DIN-C	35.6	44.0	45.0	82.0	81	1.0	6	2
	2	●		MPS1-0560-PC	12.1	28.9	28.9	66.9	66	0.9	6	2
	8	●		MPS1-0560-L8C	46.0	67.2	70.2	107.2	106	1.2	6	2
	10	□		MPS1-0560-L10C	57.0	79.0	82.0	119.0	118	1.0	6	2
	12	●		MPS1-0560-L12C	68.2	91.0	94.0	131.0	130	1.0	6	2
	15	●		MPS1-0560-L15C	85.0	109.0	112.0	149.0	148	1.0	6	2
	20	□		MPS1-0560-L20C	113.0	139.0	142.0	179.0	178	1.0	6	2
	25	□		MPS1-0560-L25C	141.0	169.0	172.0	209.0	208	1.0	6	2
	30	●		MPS1-0560-L30C	169.0	199.0	202.0	239.0	238	1.0	6	2
35	□		MPS1-0560-L35C	197.0	223.0	231.0	268.0	267	1.0	6	2	
40	●		MPS1-0560-L40C	225.0	251.0	262.0	299.0	298	1.0	6	2	
5.7	3	□		MPS1-0570S-DIN	19.5	28.0	29.0	66.0	65	1.0	6	4
	3	●		MPS1-0570S-DIN-C	19.5	28.0	29.0	66.0	65	1.0	6	2
	5	□		MPS1-0570L-DIN	35.5	44.0	45.0	82.0	81	1.0	6	4
	5	●		MPS1-0570L-DIN-C	35.5	44.0	45.0	82.0	81	1.0	6	2
	2	●		MPS1-0570-PC	12.3	28.9	28.9	66.9	66	0.9	6	2
	8	●		MPS1-0570-L8C	46.8	67.2	70.2	107.2	106	1.2	6	2
	10	□		MPS1-0570-L10C	58.0	79.0	82.0	119.0	118	1.0	6	2
	12	●		MPS1-0570-L12C	69.4	91.0	94.0	131.0	130	1.0	6	2
	15	●		MPS1-0570-L15C	86.5	109.0	112.0	149.0	148	1.0	6	2
	20	□		MPS1-0570-L20C	115.0	139.0	142.0	179.0	178	1.0	6	2
	25	●		MPS1-0570-L25C	143.5	169.0	172.0	209.0	208	1.0	6	2
	30	□		MPS1-0570-L30C	172.0	199.0	202.0	239.0	238	1.0	6	2
35	□		MPS1-0570-L35C	200.5	223.0	231.0	268.0	267	1.0	6	2	
40	●		MPS1-0570-L40C	229.0	251.0	262.0	299.0	298	1.0	6	2	

DC	Bohrtiefe (mm)	Bohrtiefe (L/D)	DP1021	Bestellnummer	Abmessungen (mm)							Typ
					LU	LCF	LH	OAL	LF	PL	DCONMS	
5.8	3	□		MPS1-0580S-DIN	19.4	28.1	29.1	66.1	65	1.1	6	4
	3	●		MPS1-0580S-DIN-C	19.4	28.1	29.1	66.1	65	1.1	6	2
	5	□		MPS1-0580L-DIN	35.4	44.1	45.1	82.1	81	1.1	6	4
	5	●		MPS1-0580L-DIN-C	35.4	44.1	45.1	82.1	81	1.1	6	2
	2	●		MPS1-0580-PC	12.5	28.9	28.9	66.9	66	0.9	6	2
	8	●		MPS1-0580-L8C	47.6	67.2	70.2	107.2	106	1.2	6	2
	10	□		MPS1-0580-L10C	59.1	79.1	82.1	119.1	118	1.1	6	2
	12	●		MPS1-0580-L12C	70.7	91.1	94.1	131.1	130	1.1	6	2
	15	●		MPS1-0580-L15C	88.1	109.1	112.1	149.1	148	1.1	6	2
	20	●		MPS1-0580-L20C	117.1	139.1	142.1	179.1	178	1.1	6	2
	25	□		MPS1-0580-L25C	146.1	169.1	172.1	209.1	208	1.1	6	2
	30	●		MPS1-0580-L30C	175.1	199.1	202.1	239.1	238	1.1	6	2
35	□		MPS1-0580-L35C	204.1	229.1	231.1	268.1	267	1.1	6	2	
40	●		MPS1-0580-L40C	233.1	261.1	262.1	299.1	298	1.1	6	2	
5.9	3	□		MPS1-0590S-DIN	19.2	28.1	29.1	66.1	65	1.1	6	4
	3	●		MPS1-0590S-DIN-C	19.2	28.1	29.1	66.1	65	1.1	6	2
	5	□		MPS1-0590L-DIN	35.2	44.1	45.1	82.1	81	1.1	6	4
	5	●		MPS1-0590L-DIN-C	35.2	44.1	45.1	82.1	81	1.1	6	2
	2	●		MPS1-0590-PC	12.7	28.9	28.9	66.9	66	0.9	6	2
	8	●		MPS1-0590-L8C	48.4	67.2	70.2	107.2	106	1.2	6	2
	10	□		MPS1-0590-L10C	60.1	79.1	82.1	119.1	118	1.1	6	2
	12	●		MPS1-0590-L12C	71.9	91.1	94.1	131.1	130	1.1	6	2
	15	●		MPS1-0590-L15C	89.6	109.1	112.1	149.1	148	1.1	6	2
	20	●		MPS1-0590-L20C	119.1	139.1	142.1	179.1	178	1.1	6	2
	25	●		MPS1-0590-L25C	148.6	169.1	172.1	209.1	208	1.1	6	2
	30	□		MPS1-0590-L30C	178.1	199.1	202.1	239.1	238	1.1	6	2
35	□		MPS1-0590-L35C	207.6	229.1	231.1	268.1	267	1.1	6	2	
40	●		MPS1-0590-L40C	237.1	261.1	262.1	299.1	298	1.1	6	2	
6.0	3	□		MPS1-0600S-DIN	19.1	28.1	29.1	66.1	65	1.1	6	4
	3	●		MPS1-0600S-DIN-C	19.1	28.1	29.1	66.1	65	1.1	6	2
	5	□		MPS1-0600L-DIN	35.1	44.1	45.1	82.1	81	1.1	6	4
	5	●		MPS1-0600L-DIN-C	35.1	44.1	45.1	82.1	81	1.1	6	2
	2	●		MPS1-0600-PC	12.9	28.9	28.9	66.9	66	0.9	6	2
	8	●		MPS1-0600-L8C	49.2	67.2	70.2	107.2	106	1.2	6	2
	10	□		MPS1-0600-L10C	61.1	79.1	82.1	119.1	118	1.1	6	2
	12	●		MPS1-0600-L12C	73.1	91.1	94.1	131.1	130	1.1	6	2
	15	●		MPS1-0600-L15C	91.1	109.1	112.1	149.1	148	1.1	6	2
	20	●		MPS1-0600-L20C	121.1	139.1	142.1	179.1	178	1.1	6	2
	25	●		MPS1-0600-L25C	151.1	169.1	172.1	209.1	208	1.1	6	2
	30	●		MPS1-0600-L30C	181.1	199.1	202.1	239.1	238	1.1	6	2
35	□		MPS1-0600-L35C	211.1	229.1	231.1	268.1	267	1.1	6	2	
40	●		MPS1-0600-L40C	241.1	261.1	262.1	299.1	298	1.1	6	2	
6.05	3	□		MPS1-0605S-DIN	25.0	34.1	42.1	79.1	78	1.1	8	4
	3	●		MPS1-0605S-DIN-C	25.0	34.1	42.1	79.1	78	1.1	8	2
	5	□		MPS1-0605L-DIN	44.0	53.1	54.1	91.1	90	1.1	8	4
	5	●		MPS1-0605L-DIN-C	44.0	53.1	54.1	91.1	90	1.1	8	2

M

BOHREN

# BOHREN (VOLLHARTMETALL)

## MPS1

4-Fasen & Super Long-VHM-Bohrer

HARTMETALL

M  
BOHREN

DC	Bohrtiefe (mm)	Bohrtiefe (L/D)	DP1021	Bestellnummer	Abmessungen (mm)								Typ
					LU	LCF	LH	OAL	LF	PL	DCONMS		
6.1	3	□	●	MPS1-0610S-DIN	25.0	34.1	42.1	79.1	78	1.1	8	4	
	3	●	●	MPS1-0610S-DIN-C	25.0	34.1	42.1	79.1	78	1.1	8	2	
	5	□	□	MPS1-0610L-DIN	44.0	53.1	54.1	91.1	90	1.1	8	4	
	5	●	●	MPS1-0610L-DIN-C	44.0	53.1	54.1	91.1	90	1.1	8	2	
	2	●	●	MPS1-0610-PC	13.2	32.0	35.0	75.0	74	1.0	8	2	
	8	●	●	MPS1-0610-L8C	50.1	73.3	76.3	113.3	112	1.3	8	2	
	10	□	□	MPS1-0610-L10C	62.1	86.1	89.1	126.1	125	1.1	8	2	
	12	●	●	MPS1-0610-L12C	74.3	99.1	102.1	139.1	138	1.1	8	2	
	15	●	●	MPS1-0610-L15C	92.6	118.1	121.1	158.1	157	1.1	8	2	
	20	●	●	MPS1-0610-L20C	123.1	151.1	154.1	191.1	190	1.1	8	2	
	25	●	●	MPS1-0610-L25C	153.6	183.1	186.1	223.1	222	1.1	8	2	
	30	●	●	MPS1-0610-L30C	184.1	216.1	219.1	256.1	255	1.1	8	2	
35	□	□	MPS1-0610-L35C	214.6	241.1	250.1	287.1	286	1.1	8	2		
40	●	●	MPS1-0610-L40C	245.1	271.1	284.1	321.1	320	1.1	8	2		
6.2	3	□	●	MPS1-0620S-DIN	24.8	34.1	42.1	79.1	78	1.1	8	4	
	3	●	●	MPS1-0620S-DIN-C	24.8	34.1	42.1	79.1	78	1.1	8	2	
	5	□	□	MPS1-0620L-DIN	43.8	53.1	54.1	91.1	90	1.1	8	4	
	5	●	●	MPS1-0620L-DIN-C	43.8	53.1	54.1	91.1	90	1.1	8	2	
	2	●	●	MPS1-0620-PC	13.4	32.0	35.0	75.0	74	1.0	8	2	
	8	●	●	MPS1-0620-L8C	50.9	73.3	76.3	113.3	112	1.3	8	2	
	10	□	□	MPS1-0620-L10C	63.1	86.1	89.1	126.1	125	1.1	8	2	
	12	●	●	MPS1-0620-L12C	75.5	99.1	102.1	139.1	138	1.1	8	2	
	15	●	●	MPS1-0620-L15C	94.1	118.1	121.1	158.1	157	1.1	8	2	
	20	●	●	MPS1-0620-L20C	125.1	151.1	154.1	191.1	190	1.1	8	2	
	25	□	□	MPS1-0620-L25C	156.1	183.1	186.1	223.1	222	1.1	8	2	
	30	●	●	MPS1-0620-L30C	187.1	216.1	219.1	256.1	255	1.1	8	2	
35	□	□	MPS1-0620-L35C	218.1	241.1	250.1	287.1	286	1.1	8	2		
40	●	●	MPS1-0620-L40C	249.1	271.1	284.1	321.1	320	1.1	8	2		
6.3	3	□	●	MPS1-0630S-DIN	24.7	34.1	42.1	79.1	78	1.1	8	4	
	3	●	●	MPS1-0630S-DIN-C	24.7	34.1	42.1	79.1	78	1.1	8	2	
	5	□	□	MPS1-0630L-DIN	43.7	53.1	54.1	91.1	90	1.1	8	4	
	5	●	●	MPS1-0630L-DIN-C	43.7	53.1	54.1	91.1	90	1.1	8	2	
	2	●	●	MPS1-0630-PC	13.6	32.0	35.0	75.0	74	1.0	8	2	
	8	●	●	MPS1-0630-L8C	51.7	73.3	76.3	113.3	112	1.3	8	2	
	10	□	□	MPS1-0630-L10C	64.1	86.1	89.1	126.1	125	1.1	8	2	
	12	●	●	MPS1-0630-L12C	76.7	99.1	102.1	139.1	138	1.1	8	2	
	15	●	●	MPS1-0630-L15C	95.6	118.1	121.1	158.1	157	1.1	8	2	
	20	●	●	MPS1-0630-L20C	127.1	151.1	154.1	191.1	190	1.1	8	2	
	25	□	□	MPS1-0630-L25C	158.6	183.1	186.1	223.1	222	1.1	8	2	
	30	●	●	MPS1-0630-L30C	190.1	216.1	219.1	256.1	255	1.1	8	2	
35	□	□	MPS1-0630-L35C	221.6	248.1	250.1	287.1	286	1.1	8	2		
40	●	●	MPS1-0630-L40C	253.1	281.1	284.1	321.1	320	1.1	8	2		
6.4	3	□	●	MPS1-0640S-DIN	24.6	34.2	42.2	79.2	78	1.2	8	4	
	3	●	●	MPS1-0640S-DIN-C	24.6	34.2	42.2	79.2	78	1.2	8	2	
	5	□	□	MPS1-0640L-DIN	43.6	53.2	54.2	91.2	90	1.2	8	4	
	5	●	●	MPS1-0640L-DIN-C	43.6	53.2	54.2	91.2	90	1.2	8	2	
	2	●	●	MPS1-0640-PC	13.8	32.0	35.0	75.0	74	1.0	8	2	
	8	●	●	MPS1-0640-L8C	52.5	73.3	76.3	113.3	112	1.3	8	2	
	10	□	□	MPS1-0640-L10C	65.2	86.2	89.2	126.2	125	1.2	8	2	
	12	●	●	MPS1-0640-L12C	78.0	99.2	102.2	139.2	138	1.2	8	2	
	15	●	●	MPS1-0640-L15C	97.2	118.2	121.2	158.2	157	1.2	8	2	
	20	●	●	MPS1-0640-L20C	129.2	151.2	154.2	191.2	190	1.2	8	2	
	25	●	●	MPS1-0640-L25C	161.2	183.2	186.2	223.2	222	1.2	8	2	
	30	●	●	MPS1-0640-L30C	193.2	216.2	219.2	256.2	255	1.2	8	2	
35	□	□	MPS1-0640-L35C	225.2	248.2	250.2	287.2	286	1.2	8	2		
40	●	●	MPS1-0640-L40C	257.2	281.2	284.2	321.2	320	1.2	8	2		

DC	Bohrtiefe (mm)	Bohrtiefe (L/D)	DP1021	Bestellnummer	Abmessungen (mm)								Typ
					LU	LCF	LH	OAL	LF	PL	DCONMS		
6.5	3	□	●	MPS1-0650S-DIN	24.4	34.2	42.2	79.2	78	1.2	8	4	
	3	●	●	MPS1-0650S-DIN-C	24.4	34.2	42.2	79.2	78	1.2	8	2	
	5	□	□	MPS1-0650L-DIN	43.4	53.2	54.2	91.2	90	1.2	8	4	
	5	●	●	MPS1-0650L-DIN-C	43.4	53.2	54.2	91.2	90	1.2	8	2	
	2	●	●	MPS1-0650-PC	14.0	32.0	35.0	75.0	74	1.0	8	2	
	8	●	●	MPS1-0650-L8C	53.3	73.3	76.3	113.3	112	1.3	8	2	
	10	□	□	MPS1-0650-L10C	66.2	86.2	89.2	126.2	125	1.2	8	2	
	12	●	●	MPS1-0650-L12C	79.2	99.2	102.2	139.2	138	1.2	8	2	
	15	●	●	MPS1-0650-L15C	98.7	118.2	121.2	158.2	157	1.2	8	2	
	20	●	●	MPS1-0650-L20C	131.2	151.2	154.2	191.2	190	1.2	8	2	
	25	●	●	MPS1-0650-L25C	163.7	183.2	186.2	223.2	222	1.2	8	2	
	30	●	●	MPS1-0650-L30C	196.2	216.2	219.2	256.2	255	1.2	8	2	
35	□	□	MPS1-0650-L35C	228.7	248.2	250.2	287.2	286	1.2	8	2		
40	●	●	MPS1-0650-L40C	261.2	281.2	284.2	321.2	320	1.2	8	2		
6.6	3	□	●	MPS1-0660S-DIN	24.3	34.2	42.2	79.2	78	1.2	8	4	
	3	●	●	MPS1-0660S-DIN-C	24.3	34.2	42.2	79.2	78	1.2	8	2	
	5	□	□	MPS1-0660L-DIN	43.3	53.2	54.2	91.2	90	1.2	8	4	
	5	●	●	MPS1-0660L-DIN-C	43.3	53.2	54.2	91.2	90	1.2	8	2	
	2	●	●	MPS1-0660-PC	14.2	35.0	37.0	75.0	74	1.0	8	2	
	8	●	●	MPS1-0660-L8C	54.2	78.4	81.4	118.4	117	1.4	8	2	
	10	□	□	MPS1-0660-L10C	67.2	92.2	95.2	132.2	131	1.2	8	2	
	12	●	●	MPS1-0660-L12C	80.4	106.2	109.2	146.2	145	1.2	8	2	
	15	●	●	MPS1-0660-L15C	100.2	127.2	130.2	167.2	166	1.2	8	2	
	20	□	□	MPS1-0660-L20C	133.2	162.2	165.2	202.2	201	1.2	8	2	
	25	●	●	MPS1-0660-L25C	166.2	197.2	200.2	237.2	236	1.2	8	2	
	30	●	●	MPS1-0660-L30C	199.2	232.2	235.2	272.2	271	1.2	8	2	
35	□	□	MPS1-0660-L35C	232.2	267.2	269.2	306.2	305	1.2	8	2		
40	●	●	MPS1-0660-L40C	265.2	301.2	304.2	341.2	340	1.2	8	2		
6.7	3	□	●	MPS1-0670S-DIN	24.2	34.2	42.2	79.2	78	1.2	8	4	
	3	●	●	MPS1-0670S-DIN-C	24.2	34.2	42.2	79.2	78	1.2	8	2	
	5	□	□	MPS1-0670L-DIN	43.2	53.2	54.2	91.2	90	1.2	8	4	
	5	●	●	MPS1-0670L-DIN-C	43.2	53.2	54.2	91.2	90	1.2	8	2	
	2	●	●	MPS1-0670-PC	14.5	35.1	37.1	75.1	74	1.1	8	2	
	8	●	●	MPS1-0670-L8C	55.0	78.4	81.4	118.4	117	1.4	8	2	
	10	□	□	MPS1-0670-L10C	68.2	92.2	95.2	132.2	131	1.2	8	2	
	12	●	●	MPS1-0670-L12C	81.6	106.2	109.2	146.2	145	1.2	8	2	
	15	●	●	MPS1-0670-L15C	101.7	127.2	130.2	167.2	166	1.2	8	2	
	20	□	□	MPS1-0670-L20C	135.2	162.2	165.2	202.2	201	1.2	8	2	
	25	□	□	MPS1-0670-L25C	168.7	197.2	200.2	237.2	236	1.2	8	2	
	30	●	●	MPS1-0670-L30C	202.2	232.2	235.2	272.2	271	1.2	8	2	
35	□	□	MPS1-0670-L35C	235.7	267.2	269.2	306.2	305	1.2	8	2		
40	●	●	MPS1-0670-L40C	269.2	301.2	304.2	341.2	340	1.2	8	2		
6.8	3	□	●	MPS1-0680S-DIN	24.0	34.2	42.2	79.2	78	1.2	8	4	
	3	●	●	MPS1-0680S-DIN-C	24.0	34.2	42.2	79.2	78	1.2	8	2	
	5	□	□	MPS1-0680L-DIN	43.0	53.2	54.2	91.2	90	1.2	8	4	
	5	●	●	MPS1-0680L-DIN-C	43.0	53.2	54.2	91.2	90	1.2	8	2	
	2	●	●	MPS1-0680-PC	14.7	35.1	37.1	75.1	74	1.1	8	2	
	8	●	●	MPS1-0680-L8C	55.8	78.4	81.4	118.4	117	1.4	8	2	
	10	□	□	MPS1-0680-L10C	69.2	92.2	95.2	132.2	131	1.2	8	2	
	12	●	●	MPS1-0680-L12C	82.8	106.2	109.2	146.2	145	1.2	8	2	
	15	●	●	MPS1-0680-L15C	103.2	127.2	130.2	167.2	166	1.2	8	2	
	20	●	●	MPS1-0680-L20C	137.2	162.2	165.2	202.2	201	1.2	8	2	
	25	●	●	MPS1-0680-L25C	171.2	197.2	200.2	237.2	236	1.2	8	2	
	30	●	●	MPS1-0680-L30C	205.2	232.2	235.2	272.2	271	1.2	8	2	
35	□	□	MPS1-0680-L35C	239.2	267.2	269.2	306.2	305	1.2	8	2		
40	●	●	MPS										

DC	Bohrtiefe (mm)	Bohrtiefe (L/D)	DP1021	Bestellnummer	Abmessungen (mm)								Typ
					LU	LCF	LH	OAL	LF	PL	DCONMS		
6.9	3	□		MPS1-0690S-DIN	23.9	34.3	42.3	79.3	78	1.3	8	4	
	3	●		MPS1-0690S-DIN-C	23.9	34.3	42.3	79.3	78	1.3	8	2	
	5	□		MPS1-0690L-DIN	42.9	53.3	54.3	91.3	90	1.3	8	4	
	5	●		MPS1-0690L-DIN-C	42.9	53.3	54.3	91.3	90	1.3	8	2	
	2	●		MPS1-0690-PC	14.9	35.1	37.1	75.1	74	1.1	8	2	
	8	●		MPS1-0690-L8C	56.6	78.4	81.4	118.4	117	1.4	8	2	
	10	□		MPS1-0690-L10C	70.3	92.3	95.3	132.3	131	1.3	8	2	
	12	●		MPS1-0690-L12C	84.1	106.3	109.3	146.3	145	1.3	8	2	
	15	●		MPS1-0690-L15C	104.8	127.3	130.3	167.3	166	1.3	8	2	
	20	●		MPS1-0690-L20C	139.3	162.3	165.3	202.3	201	1.3	8	2	
	25	●		MPS1-0690-L25C	173.8	197.3	200.3	237.3	236	1.3	8	2	
	30	●		MPS1-0690-L30C	208.3	232.3	235.3	272.3	271	1.3	8	2	
35	□		MPS1-0690-L35C	242.8	267.3	269.3	306.3	305	1.3	8	2		
40	●		MPS1-0690-L40C	277.3	301.3	304.3	341.3	340	1.3	8	2		
7.0	3	□		MPS1-0700S-DIN	23.8	34.3	42.3	79.3	78	1.3	8	4	
	3	●		MPS1-0700S-DIN-C	23.8	34.3	42.3	79.3	78	1.3	8	2	
	5	□		MPS1-0700L-DIN	42.8	53.3	54.3	91.3	90	1.3	8	4	
	5	●		MPS1-0700L-DIN-C	42.8	53.3	54.3	91.3	90	1.3	8	2	
	2	●		MPS1-0700-PC	15.1	35.1	37.1	75.1	74	1.1	8	2	
	8	●		MPS1-0700-L8C	57.4	78.4	81.4	118.4	117	1.4	8	2	
	10	●		MPS1-0700-L10C	71.3	92.3	95.3	132.3	131	1.3	8	2	
	12	●		MPS1-0700-L12C	85.3	106.3	109.3	146.3	145	1.3	8	2	
	15	●		MPS1-0700-L15C	106.3	127.3	130.3	167.3	166	1.3	8	2	
	20	●		MPS1-0700-L20C	141.3	162.3	165.3	202.3	201	1.3	8	2	
	25	●		MPS1-0700-L25C	176.3	197.3	200.3	237.3	236	1.3	8	2	
	30	●		MPS1-0700-L30C	211.3	232.3	235.3	272.3	271	1.3	8	2	
35	□		MPS1-0700-L35C	246.3	267.3	269.3	306.3	305	1.3	8	2		
40	●		MPS1-0700-L40C	281.3	301.3	304.3	341.3	340	1.3	8	2		
7.1	3	□		MPS1-0710S-DIN	30.6	41.3	42.3	79.3	78	1.3	8	4	
	3	●		MPS1-0710S-DIN-C	30.6	41.3	42.3	79.3	78	1.3	8	2	
	5	□		MPS1-0710L-DIN	42.6	53.3	54.3	91.3	90	1.3	8	4	
	5	●		MPS1-0710L-DIN-C	42.6	53.3	54.3	91.3	90	1.3	8	2	
	2	●		MPS1-0710-PC	15.3	35.1	38.1	80.1	79	1.1	8	2	
	8	●		MPS1-0710-L8C	58.3	84.5	87.5	124.5	123	1.5	8	2	
	10	□		MPS1-0710-L10C	72.3	99.3	102.3	139.3	138	1.3	8	2	
	12	●		MPS1-0710-L12C	86.5	114.3	117.3	154.3	153	1.3	8	2	
	15	●		MPS1-0710-L15C	107.8	136.3	139.3	176.3	175	1.3	8	2	
	20	●		MPS1-0710-L20C	143.3	174.3	177.3	214.3	213	1.3	8	2	
	25	●		MPS1-0710-L25C	178.8	211.3	214.3	251.3	250	1.3	8	2	
	30	●		MPS1-0710-L30C	214.3	249.3	252.3	289.3	288	1.3	8	2	
35	□		MPS1-0710-L35C	249.8	286.3	288.3	325.3	324	1.3	8	2		
40	●		MPS1-0710-L40C	285.3	321.3	323.3	360.3	359	1.3	8	2		
7.2	3	□		MPS1-0720S-DIN	30.5	41.3	42.3	79.3	78	1.3	8	4	
	3	●		MPS1-0720S-DIN-C	30.5	41.3	42.3	79.3	78	1.3	8	2	
	5	□		MPS1-0720L-DIN	42.5	53.3	54.3	91.3	90	1.3	8	4	
	5	●		MPS1-0720L-DIN-C	42.5	53.3	54.3	91.3	90	1.3	8	2	
	2	●		MPS1-0720-PC	15.5	35.1	38.1	80.1	79	1.1	8	2	
	8	●		MPS1-0720-L8C	59.1	84.5	87.5	124.5	123	1.5	8	2	
	10	□		MPS1-0720-L10C	73.3	99.3	102.3	139.3	138	1.3	8	2	
	12	●		MPS1-0720-L12C	87.7	114.3	117.3	154.3	153	1.3	8	2	
	15	□		MPS1-0720-L15C	109.3	136.3	139.3	176.3	175	1.3	8	2	
	20	□		MPS1-0720-L20C	145.3	174.3	177.3	214.3	213	1.3	8	2	
	25	□		MPS1-0720-L25C	181.3	211.3	214.3	251.3	250	1.3	8	2	
	30	□		MPS1-0720-L30C	217.3	249.3	252.3	289.3	288	1.3	8	2	
35	□		MPS1-0720-L35C	253.3	286.3	288.3	325.3	324	1.3	8	2		
40	●		MPS1-0720-L40C	289.3	321.3	323.3	360.3	359	1.3	8	2		

DC	Bohrtiefe (mm)	Bohrtiefe (L/D)	DP1021	Bestellnummer	Abmessungen (mm)								Typ
					LU	LCF	LH	OAL	LF	PL	DCONMS		
7.3	3	□		MPS1-0730S-DIN	30.4	41.3	42.3	79.3	78	1.3	8	4	
	3	●		MPS1-0730S-DIN-C	30.4	41.3	42.3	79.3	78	1.3	8	2	
	5	□		MPS1-0730L-DIN	42.4	53.3	54.3	91.3	90	1.3	8	4	
	5	●		MPS1-0730L-DIN-C	42.4	53.3	54.3	91.3	90	1.3	8	2	
	2	●		MPS1-0730-PC	15.8	35.2	38.2	80.2	79	1.2	8	2	
	8	●		MPS1-0730-L8C	59.9	84.5	87.5	124.5	123	1.5	8	2	
	10	□		MPS1-0730-L10C	74.3	99.3	102.3	139.3	138	1.3	8	2	
	12	●		MPS1-0730-L12C	88.9	114.3	117.3	154.3	153	1.3	8	2	
	15	□		MPS1-0730-L15C	110.8	136.3	139.3	176.3	175	1.3	8	2	
	20	□		MPS1-0730-L20C	147.3	174.3	177.3	214.3	213	1.3	8	2	
	25	□		MPS1-0730-L25C	183.8	211.3	214.3	251.3	250	1.3	8	2	
	30	□		MPS1-0730-L30C	220.3	249.3	252.3	289.3	288	1.3	8	2	
35	□		MPS1-0730-L35C	256.8	286.3	288.3	325.3	324	1.3	8	2		
40	●		MPS1-0730-L40C	293.3	321.3	323.3	360.3	359	1.3	8	2		
7.4	3	□		MPS1-0740S-DIN	30.2	41.3	42.3	79.3	78	1.3	8	4	
	3	●		MPS1-0740S-DIN-C	30.2	41.3	42.3	79.3	78	1.3	8	2	
	5	□		MPS1-0740L-DIN	42.2	53.3	54.3	91.3	90	1.3	8	4	
	5	●		MPS1-0740L-DIN-C	42.2	53.3	54.3	91.3	90	1.3	8	2	
	2	●		MPS1-0740-PC	16.0	35.2	38.2	80.2	79	1.2	8	2	
	8	●		MPS1-0740-L8C	60.7	84.5	87.5	124.5	123	1.5	8	2	
	10	□		MPS1-0740-L10C	75.3	99.3	102.3	139.3	138	1.3	8	2	
	12	●		MPS1-0740-L12C	90.1	114.3	117.3	154.3	153	1.3	8	2	
	15	□		MPS1-0740-L15C	112.3	136.3	139.3	176.3	175	1.3	8	2	
	20	□		MPS1-0740-L20C	149.3	174.3	177.3	214.3	213	1.3	8	2	
	25	□		MPS1-0740-L25C	186.3	211.3	214.3	251.3	250	1.3	8	2	
	30	□		MPS1-0740-L30C	223.3	249.3	252.3	289.3	288	1.3	8	2	
35	□		MPS1-0740-L35C	260.3	286.3	288.3	325.3	324	1.3	8	2		
40	●		MPS1-0740-L40C	297.3	321.3	323.3	360.3	359	1.3	8	2		
7.5	3	□		MPS1-0750S-DIN	30.1	41.4	42.4	79.4	78	1.4	8	4	
	3	●		MPS1-0750S-DIN-C	30.1	41.4	42.4	79.4	78	1.4	8	2	
	5	□		MPS1-0750L-DIN	42.1	53.4	54.4	91.4	90	1.4	8	4	
	5	●		MPS1-0750L-DIN-C	42.1	53.4	54.4	91.4	90	1.4	8	2	
	2	●		MPS1-0750-PC	16.2	35.2	38.2	80.2	79	1.2	8	2	
	8	●		MPS1-0750-L8C	61.6	84.6	87.6	124.6	123	1.6	8	2	
	10	□		MPS1-0750-L10C	76.4	99.4	102.4	139.4	138	1.4	8	2	
	12	●		MPS1-0750-L12C	91.4	114.4	117.4	154.4	153	1.4	8	2	
	15	●		MPS1-0750-L15C	113.9	136.4	139.4	176.4	175	1.4	8	2	
	20	●		MPS1-0750-L20C	151.4	174.4	177.4	214.4	213	1.4	8	2	
	25	●		MPS1-0750-L25C	188.9	211.4	214.4	251.4	250	1.4	8	2	
	30	●		MPS1-0750-L30C	226.4	249.4	252.4	289.4	288	1.4	8	2	
35	□		MPS1-0750-L35C	263.9	286.4	288.4	325.4	324	1.4	8	2		
40	●		MPS1-0750-L40C	301.4	321.4	323.4	360.4	359	1.4	8	2		
7.6	3	□		MPS1-0760S-DIN	30.0	41.4	42.4	79.4	78	1.4	8	4	
	3	●		MPS1-0760S-DIN-C	30.0	41.4	42.4	79.4	78	1.4	8	2	
	5	□		MPS1-0760L-DIN	42.0	53.4	54.4	91.4	90	1.4	8	4	
	5	●		MPS1-0760L-DIN-C	42.0	53.4	54.4	91.4	90	1.4	8	2	
	2	●		MPS1-0760-PC	16.4	38.2	38.2	80.2	79	1.2	8	2	
	8	●		MPS1-0760-L8C	62.4	89.6	92.6	129.6	128	1.6	8	2	
	10	□		MPS1-0760-L10C	77.4	105.4	108.4	145.4	144	1.4	8	2	
	12	●		MPS1-0760-L12C	92.6	121.4	124.4	161.4	160	1.4	8	2	
	15	●		MPS1-0760-L15C	115.4	145.4	148.4	185.4	184	1.4	8	2	
	20	□		MPS1-0760-L20C	153.4	185.4	188.4	225.4	224	1.4	8	2	
	25	□		MPS1-0760-L25C	191.4	225.4	228.4	265.4	264	1.4	8	2	
	30	□		MPS1-0760-L30C	229.4	265.4	268.4	305.4	304	1.4	8	2	
35	□		MPS1-0760-L35C	267.4	305.4	307.4	344.4	343	1.4	8	2		
40	●		MPS1-0760-L40C	305.4	341.4	342.4	379.4	378	1.4	8	2		

M

BOHREN

# BOHREN (VOLLHARTMETALL)

## MPS1

4-Fasen & Super Long-VHM-Bohrer

HARTMETALL

M  
BOHREN

DC	Bohrtiefe (mm)	Bohrtiefe (L/D)	DP1021	Bestellnummer	Abmessungen (mm)							Typ
					LU	LCF	LH	OAL	LF	PL	DCONMS	
7.7	3	□	●	MPS1-0770S-DIN	29.9	41.4	42.4	79.4	78	1.4	8	4
	3	●	●	MPS1-0770S-DIN-C	29.9	41.4	42.4	79.4	78	1.4	8	2
	5	□	□	MPS1-0770L-DIN	41.9	53.4	54.4	91.4	90	1.4	8	4
	5	●	●	MPS1-0770L-DIN-C	41.9	53.4	54.4	91.4	90	1.4	8	2
	2	●	●	MPS1-0770-PC	16.6	38.2	38.2	80.2	79	1.2	8	2
	8	●	●	MPS1-0770-L8C	63.2	89.6	92.6	129.6	128	1.6	8	2
	10	□	□	MPS1-0770-L10C	78.4	105.4	108.4	145.4	144	1.4	8	2
	12	●	●	MPS1-0770-L12C	93.8	121.4	124.4	161.4	160	1.4	8	2
	15	●	●	MPS1-0770-L15C	116.9	145.4	148.4	185.4	184	1.4	8	2
	20	□	□	MPS1-0770-L20C	155.4	185.4	188.4	225.4	224	1.4	8	2
	25	●	●	MPS1-0770-L25C	193.9	225.4	228.4	265.4	264	1.4	8	2
	30	□	□	MPS1-0770-L30C	232.4	265.4	268.4	305.4	304	1.4	8	2
35	□	□	MPS1-0770-L35C	270.9	305.4	307.4	344.4	343	1.4	8	2	
40	●	●	MPS1-0770-L40C	309.4	341.4	342.4	379.4	378	1.4	8	2	
7.8	3	□	●	MPS1-0780S-DIN	29.7	41.4	42.4	79.4	78	1.4	8	4
	3	●	●	MPS1-0780S-DIN-C	29.7	41.4	42.4	79.4	78	1.4	8	2
	5	□	□	MPS1-0780L-DIN	41.7	53.4	54.4	91.4	90	1.4	8	4
	5	●	●	MPS1-0780L-DIN-C	41.7	53.4	54.4	91.4	90	1.4	8	2
	2	●	●	MPS1-0780-PC	16.8	38.2	38.2	80.2	79	1.2	8	2
	8	●	●	MPS1-0780-L8C	64.0	89.6	92.6	129.6	128	1.6	8	2
	10	□	□	MPS1-0780-L10C	79.4	105.4	108.4	145.4	144	1.4	8	2
	12	●	●	MPS1-0780-L12C	95.0	121.4	124.4	161.4	160	1.4	8	2
	15	●	●	MPS1-0780-L15C	118.4	145.4	148.4	185.4	184	1.4	8	2
	20	□	□	MPS1-0780-L20C	157.4	185.4	188.4	225.4	224	1.4	8	2
	25	□	□	MPS1-0780-L25C	196.4	225.4	228.4	265.4	264	1.4	8	2
	30	●	●	MPS1-0780-L30C	235.4	265.4	268.4	305.4	304	1.4	8	2
35	□	□	MPS1-0780-L35C	274.4	305.4	307.4	344.4	343	1.4	8	2	
40	●	●	MPS1-0780-L40C	313.4	341.4	342.4	379.4	378	1.4	8	2	
7.9	3	□	●	MPS1-0790S-DIN	29.6	41.4	42.4	79.4	78	1.4	8	4
	3	●	●	MPS1-0790S-DIN-C	29.6	41.4	42.4	79.4	78	1.4	8	2
	5	□	□	MPS1-0790L-DIN	41.6	53.4	54.4	91.4	90	1.4	8	4
	5	●	●	MPS1-0790L-DIN-C	41.6	53.4	54.4	91.4	90	1.4	8	2
	2	●	●	MPS1-0790-PC	17.0	38.2	38.2	80.2	79	1.2	8	2
	8	●	●	MPS1-0790-L8C	64.8	89.6	92.6	129.6	128	1.6	8	2
	10	□	□	MPS1-0790-L10C	80.4	105.4	108.4	145.4	144	1.4	8	2
	12	●	●	MPS1-0790-L12C	96.2	121.4	124.4	161.4	160	1.4	8	2
	15	□	□	MPS1-0790-L15C	119.9	145.4	148.4	185.4	184	1.4	8	2
	20	□	□	MPS1-0790-L20C	159.4	185.4	188.4	225.4	224	1.4	8	2
	25	●	●	MPS1-0790-L25C	198.9	225.4	228.4	265.4	264	1.4	8	2
	30	●	●	MPS1-0790-L30C	238.4	265.4	268.4	305.4	304	1.4	8	2
35	□	□	MPS1-0790-L35C	277.9	305.4	307.4	344.4	343	1.4	8	2	
40	●	●	MPS1-0790-L40C	317.4	341.4	342.4	379.4	378	1.4	8	2	
8.0	3	□	●	MPS1-0800S-DIN	29.5	41.5	42.5	79.5	78	1.5	8	4
	3	●	●	MPS1-0800S-DIN-C	29.5	41.5	42.5	79.5	78	1.5	8	2
	5	□	□	MPS1-0800L-DIN	41.5	53.5	54.5	91.5	90	1.5	8	4
	5	●	●	MPS1-0800L-DIN-C	41.5	53.5	54.5	91.5	90	1.5	8	2
	2	●	●	MPS1-0800-PC	17.3	38.3	38.3	80.3	79	1.3	8	2
	8	●	●	MPS1-0800-L8C	65.7	89.7	92.7	129.7	128	1.7	8	2
	10	●	●	MPS1-0800-L10C	81.5	105.5	108.5	145.5	144	1.5	8	2
	12	●	●	MPS1-0800-L12C	97.5	121.5	124.5	161.5	160	1.5	8	2
	15	●	●	MPS1-0800-L15C	121.5	145.5	148.5	185.5	184	1.5	8	2
	20	●	●	MPS1-0800-L20C	161.5	185.5	188.5	225.5	224	1.5	8	2
	25	●	●	MPS1-0800-L25C	201.5	225.5	228.5	265.5	264	1.5	8	2
	30	●	●	MPS1-0800-L30C	241.5	265.5	268.5	305.5	304	1.5	8	2
35	□	□	MPS1-0800-L35C	281.5	305.5	307.5	344.5	343	1.5	8	2	
40	●	●	MPS1-0800-L40C	321.5	341.5	342.5	379.5	378	1.5	8	2	

DC	Bohrtiefe (mm)	Bohrtiefe (L/D)	DP1021	Bestellnummer	Abmessungen (mm)							Typ
					LU	LCF	LH	OAL	LF	PL	DCONMS	
8.05	3	□	●	MPS1-0805S-DIN	34.4	46.5	47.5	88.5	87	1.5	10	4
	3	●	●	MPS1-0805S-DIN-C	34.4	46.5	47.5	88.5	87	1.5	10	2
	5	□	□	MPS1-0805L-DIN	48.4	60.5	61.5	102.5	101	1.5	10	4
	5	●	●	MPS1-0805L-DIN-C	48.4	60.5	61.5	102.5	101	1.5	10	2
8.1	3	□	●	MPS1-0810S-DIN	34.3	46.5	47.5	88.5	87	1.5	10	4
	3	●	●	MPS1-0810S-DIN-C	34.3	46.5	47.5	88.5	87	1.5	10	2
	5	□	□	MPS1-0810L-DIN	48.3	60.5	61.5	102.5	101	1.5	10	4
	5	●	●	MPS1-0810L-DIN-C	48.3	60.5	61.5	102.5	101	1.5	10	2
	2	●	●	MPS1-0810-PC	17.5	38.3	41.3	85.3	84	1.3	10	2
	8	●	●	MPS1-0810-L8C	66.5	95.7	98.7	139.7	138	1.7	10	2
	10	□	□	MPS1-0810-L10C	82.5	112.5	115.5	156.5	155	1.5	10	2
	12	●	●	MPS1-0810-L12C	98.7	129.5	132.5	173.5	172	1.5	10	2
	15	●	●	MPS1-0810-L15C	123.0	154.5	157.5	198.5	197	1.5	10	2
	20	●	●	MPS1-0810-L20C	163.5	197.5	200.5	241.5	240	1.5	10	2
	25	□	□	MPS1-0810-L25C	204.0	239.5	242.5	283.5	282	1.5	10	2
	30	□	□	MPS1-0810-L30C	244.5	282.5	284.5	325.5	324	1.5	10	2
35	□	□	MPS1-0810-L35C	285.0	324.5	326.5	367.5	366	1.5	10	2	
40	●	●	MPS1-0810-L40C	325.5	366.5	370.5	411.5	410	1.5	10	2	
8.2	3	□	●	MPS1-0820S-DIN	34.2	46.5	47.5	88.5	87	1.5	10	4
	3	●	●	MPS1-0820S-DIN-C	34.2	46.5	47.5	88.5	87	1.5	10	2
	5	□	□	MPS1-0820L-DIN	48.2	60.5	61.5	102.5	101	1.5	10	4
	5	●	●	MPS1-0820L-DIN-C	48.2	60.5	61.5	102.5	101	1.5	10	2
	2	●	●	MPS1-0820-PC	17.7	38.3	41.3	85.3	84	1.3	10	2
	8	●	●	MPS1-0820-L8C	67.3	95.7	98.7	139.7	138	1.7	10	2
	10	□	□	MPS1-0820-L10C	83.5	112.5	115.5	156.5	155	1.5	10	2
	12	●	●	MPS1-0820-L12C	99.9	129.5	132.5	173.5	172	1.5	10	2
	15	●	●	MPS1-0820-L15C	124.5	154.5	157.5	198.5	197	1.5	10	2
	20	●	●	MPS1-0820-L20C	165.5	197.5	200.5	241.5	240	1.5	10	2
	25	□	□	MPS1-0820-L25C	206.5	239.5	242.5	283.5	282	1.5	10	2
	30	□	□	MPS1-0820-L30C	247.5	282.5	284.5	325.5	324	1.5	10	2
35	□	□	MPS1-0820-L35C	288.5	324.5	326.5	367.5	366	1.5	10	2	
40	●	●	MPS1-0820-L40C	329.5	366.5	370.5	411.5	410	1.5	10	2	
8.3	3	□	●	MPS1-0830S-DIN	34.1	46.5	47.5	88.5	87	1.5	10	4
	3	●	●	MPS1-0830S-DIN-C	34.1	46.5	47.5	88.5	87	1.5	10	2
	5	□	□	MPS1-0830L-DIN	48.1	60.5	61.5	102.5	101	1.5	10	4
	5	●	●	MPS1-0830L-DIN-C	48.1	60.5	61.5	102.5	101	1.5	10	2
	2	●	●	MPS1-0830-PC	17.9	38.3	41.3	85.3	84	1.3	10	2
	8	●	●	MPS1-0830-L8C	68.1	95.7	98.7	139.7	138	1.7	10	2
	10	□	□	MPS1-0830-L10C	84.5	112.5	115.5	156.5	155	1.5	10	2
	12	●	●	MPS1-0830-L12C	101.1	129.5	132.5	173.5	172	1.5	10	2
	15	□	□	MPS1-0830-L15C	126.0	154.5	157.5	198.5	197	1.5	10	2
	20	□	□	MPS1-0830-L20C	167.5	197.5	200.5	241.5	240	1.5	10	2
	25	□	□	MPS1-0830-L25C	209.0	239.5	242.5	283.5	282	1.5	10	2
	30	□	□	MPS1-0830-L30C	250.5	282.5	284.5	325.5	324	1.5	10	2
35	□	□	MPS1-0830-L35C	292.0	324.5	326.5	367.5	366	1.5	10	2	
40	●	●	MPS1-0830-L40C	333.5	366.5	370.5	411.5	410	1.5	10	2	

● : Lagerstandard. □ : Herstellung nur auf Anfrage.

DC	Bohrtiefe (mm)	Bohrtiefe (L/D)	DP1021	Bestellnummer	Abmessungen (mm)							Typ
					LU	LCF	LH	OAL	LF	PL	DCONMS	
8.4	3	□		MPS1-0840S-DIN	33.9	46.5	47.5	88.5	87	1.5	10	4
	3	●		MPS1-0840S-DIN-C	33.9	46.5	47.5	88.5	87	1.5	10	2
	5	□		MPS1-0840L-DIN	47.9	60.5	61.5	102.5	101	1.5	10	4
	5	●		MPS1-0840L-DIN-C	47.9	60.5	61.5	102.5	101	1.5	10	2
	2	●		MPS1-0840-PC	18.1	38.3	41.3	85.3	84	1.3	10	2
	8	●		MPS1-0840-L8C	68.9	95.7	98.7	139.7	138	1.7	10	2
	10	□		MPS1-0840-L10C	85.5	112.5	115.5	156.5	155	1.5	10	2
	12	●		MPS1-0840-L12C	102.3	129.5	132.5	173.5	172	1.5	10	2
	15	●		MPS1-0840-L15C	127.5	154.5	157.5	198.5	197	1.5	10	2
	20	□		MPS1-0840-L20C	169.5	197.5	200.5	241.5	240	1.5	10	2
	25	□		MPS1-0840-L25C	211.5	239.5	242.5	283.5	282	1.5	10	2
	30	□		MPS1-0840-L30C	253.5	282.5	284.5	325.5	324	1.5	10	2
35	□		MPS1-0840-L35C	295.5	324.5	326.5	367.5	366	1.5	10	2	
40	●		MPS1-0840-L40C	337.5	366.5	370.5	411.5	410	1.5	10	2	
8.5	3	□		MPS1-0850S-DIN	33.8	46.5	47.5	88.5	87	1.5	10	4
	3	●		MPS1-0850S-DIN-C	33.8	46.5	47.5	88.5	87	1.5	10	2
	5	□		MPS1-0850L-DIN	47.8	60.5	61.5	102.5	101	1.5	10	4
	5	●		MPS1-0850L-DIN-C	47.8	60.5	61.5	102.5	101	1.5	10	2
	2	●		MPS1-0850-PC	18.3	38.3	41.3	85.3	84	1.3	10	2
	8	●		MPS1-0850-L8C	69.8	95.8	98.8	139.8	138	1.8	10	2
	10	□		MPS1-0850-L10C	86.5	112.5	115.5	156.5	155	1.5	10	2
	12	●		MPS1-0850-L12C	103.5	129.5	132.5	173.5	172	1.5	10	2
	15	●		MPS1-0850-L15C	129.0	154.5	157.5	198.5	197	1.5	10	2
	20	●		MPS1-0850-L20C	171.5	197.5	200.5	241.5	240	1.5	10	2
	25	●		MPS1-0850-L25C	214.0	239.5	242.5	283.5	282	1.5	10	2
	30	●		MPS1-0850-L30C	256.5	282.5	284.5	325.5	324	1.5	10	2
35	□		MPS1-0850-L35C	299.0	324.5	326.5	367.5	366	1.5	10	2	
40	●		MPS1-0850-L40C	341.5	366.5	370.5	411.5	410	1.5	10	2	
8.6	3	□		MPS1-0860S-DIN	33.7	46.6	47.6	88.6	87	1.6	10	4
	3	●		MPS1-0860S-DIN-C	33.7	46.6	47.6	88.6	87	1.6	10	2
	5	□		MPS1-0860L-DIN	47.7	60.6	61.6	102.6	101	1.6	10	4
	5	●		MPS1-0860L-DIN-C	47.7	60.6	61.6	102.6	101	1.6	10	2
	2	●		MPS1-0860-PC	18.6	41.4	43.4	85.4	84	1.4	10	2
	8	●		MPS1-0860-L8C	70.6	100.8	103.8	144.8	143	1.8	10	2
	10	□		MPS1-0860-L10C	87.6	118.6	121.6	162.6	161	1.6	10	2
	12	●		MPS1-0860-L12C	104.8	136.6	139.6	180.6	179	1.6	10	2
	15	●		MPS1-0860-L15C	130.6	163.6	166.6	207.6	206	1.6	10	2
	20	□		MPS1-0860-L20C	173.6	208.6	211.6	252.6	251	1.6	10	2
	25	●		MPS1-0860-L25C	216.6	253.6	256.6	297.6	296	1.6	10	2
	30	●		MPS1-0860-L30C	259.6	298.6	300.6	341.6	340	1.6	10	2
35	□		MPS1-0860-L35C	302.6	343.6	345.6	386.6	385	1.6	10	2	
40	●		MPS1-0860-L40C	345.6	391.6	394.6	435.6	434	1.6	10	2	
8.7	3	□		MPS1-0870S-DIN	33.5	46.6	47.6	88.6	87	1.6	10	4
	3	●		MPS1-0870S-DIN-C	33.5	46.6	47.6	88.6	87	1.6	10	2
	5	□		MPS1-0870L-DIN	47.5	60.6	61.6	102.6	101	1.6	10	4
	5	●		MPS1-0870L-DIN-C	47.5	60.6	61.6	102.6	101	1.6	10	2
	2	●		MPS1-0870-PC	18.8	41.4	43.4	85.4	84	1.4	10	2
	8	●		MPS1-0870-L8C	71.4	100.8	103.8	144.8	143	1.8	10	2
	10	□		MPS1-0870-L10C	88.6	118.6	121.6	162.6	161	1.6	10	2
	12	●		MPS1-0870-L12C	106.0	136.6	139.6	180.6	179	1.6	10	2
	15	●		MPS1-0870-L15C	132.1	163.6	166.6	207.6	206	1.6	10	2
	20	□		MPS1-0870-L20C	175.6	208.6	211.6	252.6	251	1.6	10	2
	25	●		MPS1-0870-L25C	219.1	253.6	256.6	297.6	296	1.6	10	2
	30	□		MPS1-0870-L30C	262.6	298.6	300.6	341.6	340	1.6	10	2
35	□		MPS1-0870-L35C	306.1	343.6	345.6	386.6	385	1.6	10	2	
40	●		MPS1-0870-L40C	349.6	391.6	394.6	435.6	434	1.6	10	2	

DC	Bohrtiefe (mm)	Bohrtiefe (L/D)	DP1021	Bestellnummer	Abmessungen (mm)							Typ
					LU	LCF	LH	OAL	LF	PL	DCONMS	
8.8	3	□		MPS1-0880S-DIN	33.4	46.6	47.6	88.6	87	1.6	10	4
	3	●		MPS1-0880S-DIN-C	33.4	46.6	47.6	88.6	87	1.6	10	2
	5	□		MPS1-0880L-DIN	47.4	60.6	61.6	102.6	101	1.6	10	4
	5	●		MPS1-0880L-DIN-C	47.4	60.6	61.6	102.6	101	1.6	10	2
	2	●		MPS1-0880-PC	19.0	41.4	43.4	85.4	84	1.4	10	2
	8	●		MPS1-0880-L8C	72.2	100.8	103.8	144.8	143	1.8	10	2
	10	□		MPS1-0880-L10C	89.6	118.6	121.6	162.6	161	1.6	10	2
	12	●		MPS1-0880-L12C	107.2	136.6	139.6	180.6	179	1.6	10	2
	15	●		MPS1-0880-L15C	133.6	163.6	166.6	207.6	206	1.6	10	2
	20	●		MPS1-0880-L20C	177.6	208.6	211.6	252.6	251	1.6	10	2
	25	●		MPS1-0880-L25C	221.6	253.6	256.6	297.6	296	1.6	10	2
	30	●		MPS1-0880-L30C	265.6	298.6	300.6	341.6	340	1.6	10	2
35	□		MPS1-0880-L35C	309.6	343.6	345.6	386.6	385	1.6	10	2	
40	●		MPS1-0880-L40C	353.6	391.6	394.6	435.6	434	1.6	10	2	
8.9	3	□		MPS1-0890S-DIN	33.3	46.6	47.6	88.6	87	1.6	10	4
	3	●		MPS1-0890S-DIN-C	33.3	46.6	47.6	88.6	87	1.6	10	2
	5	□		MPS1-0890L-DIN	47.3	60.6	61.6	102.6	101	1.6	10	4
	5	●		MPS1-0890L-DIN-C	47.3	60.6	61.6	102.6	101	1.6	10	2
	2	●		MPS1-0890-PC	19.2	41.4	43.4	85.4	84	1.4	10	2
	8	●		MPS1-0890-L8C	73.0	100.8	103.8	144.8	143	1.8	10	2
	10	□		MPS1-0890-L10C	90.6	118.6	121.6	162.6	161	1.6	10	2
	12	●		MPS1-0890-L12C	108.4	136.6	139.6	180.6	179	1.6	10	2
	15	□		MPS1-0890-L15C	135.1	163.6	166.6	207.6	206	1.6	10	2
	20	□		MPS1-0890-L20C	179.6	208.6	211.6	252.6	251	1.6	10	2
	25	□		MPS1-0890-L25C	224.1	253.6	256.6	297.6	296	1.6	10	2
	30	□		MPS1-0890-L30C	268.6	298.6	300.6	341.6	340	1.6	10	2
35	□		MPS1-0890-L35C	313.1	343.6	345.6	386.6	385	1.6	10	2	
40	●		MPS1-0890-L40C	357.6	391.6	394.6	435.6	434	1.6	10	2	
9.0	3	□		MPS1-0900S-DIN	33.1	46.6	47.6	88.6	87	1.6	10	4
	3	●		MPS1-0900S-DIN-C	33.1	46.6	47.6	88.6	87	1.6	10	2
	5	□		MPS1-0900L-DIN	47.1	60.6	61.6	102.6	101	1.6	10	4
	5	●		MPS1-0900L-DIN-C	47.1	60.6	61.6	102.6	101	1.6	10	2
	2	●		MPS1-0900-PC	19.4	41.4	43.4	85.4	84	1.4	10	2
	8	●		MPS1-0900-L8C	73.9	100.9	103.9	144.9	143	1.9	10	2
	10	□		MPS1-0900-L10C	91.6	118.6	121.6	162.6	161	1.6	10	2
	12	●		MPS1-0900-L12C	109.6	136.6	139.6	180.6	179	1.6	10	2
	15	●		MPS1-0900-L15C	136.6	163.6	166.6	207.6	206	1.6	10	2
	20	●		MPS1-0900-L20C	181.6	208.6	211.6	252.6	251	1.6	10	2
	25	●		MPS1-0900-L25C	226.6	253.6	256.6	297.6	296	1.6	10	2
	30	●		MPS1-0900-L30C	271.6	298.6	300.6	341.6	340	1.6	10	2
35	□		MPS1-0900-L35C	316.6	343.6	345.6	386.6	385	1.6	10	2	
40	●		MPS1-0900-L40C	361.6	391.6	394.6	435.6	434	1.6	10	2	
9.1	3	□		MPS1-0910S-DIN	33.0	46.7	47.7	88.7	87	1.7	10	4
	3	●		MPS1-0910S-DIN-C	33.0	46.7	47.7	88.7	87	1.7	10	2
	5	□		MPS1-0910L-DIN	47.0	60.7	61.7	102.7	101	1.7	10	4
	5	●		MPS1-0910L-DIN-C	47.0	60.7	61.7	102.7	101	1.7	10	2
	2	●		MPS1-0910-PC	19.6	41.4	44.4	90.4	89	1.4	10	2
	8	●		MPS1-0910-L8C	74.7	106.9	109.9	150.9	149	1.9	10	2
	10	□		MPS1-0910-L10C	92.7	125.7	128.7	169.7	168	1.7	10	2
	12	●		MPS1-0910-L12C	110.9	144.7	147.7	188.7	187	1.7	10	2
	15	●		MPS1-0910-L15C	138.2	172.7	175.7	216.7	215	1.7	10	2
	20	□		MPS1-0910-L20C	183.7	220.7	223.7	264.7	263	1.7	10	2
	25	□		MPS1-0910-L25C	229.2	267.7	270.7	311.7	310	1.7	10	2
	30	●		MPS1-0910-L30C	274.7	315.7	318.7	359.7	358	1.7	10	2
35	□		MPS1-0910-L35C	320.2	362.7	364.7	405.7	404	1.7	10	2	

M

BOHREN

# BOHREN (VOLLHARTMETALL)

## MPS1

4-Fasen & Super Long-VHM-Bohrer

HARTMETALL

M  
BOHREN

DC	Bohrtiefe (mm)	Bohrtiefe (L/D)	DP1021	Bestellnummer	Abmessungen (mm)							Typ
					LU	LCF	LH	OAL	LF	PL	DCONMS	
9.2	3	□		MPS1-0920S-DIN	32.9	46.7	47.7	88.7	87	1.7	10	4
	3	●		MPS1-0920S-DIN-C	32.9	46.7	47.7	88.7	87	1.7	10	2
	5	□		MPS1-0920L-DIN	46.9	60.7	61.7	102.7	101	1.7	10	4
	5	●		MPS1-0920L-DIN-C	46.9	60.7	61.7	102.7	101	1.7	10	2
	2	●		MPS1-0920-PC	19.9	41.5	44.5	90.5	89	1.5	10	2
	8	●		MPS1-0920-L8C	75.5	106.9	109.9	150.9	149	1.9	10	2
	10	□		MPS1-0920-L10C	93.7	125.7	128.7	169.7	168	1.7	10	2
	12	●		MPS1-0920-L12C	112.1	144.7	147.7	188.7	187	1.7	10	2
	15	●		MPS1-0920-L15C	139.7	172.7	175.7	216.7	215	1.7	10	2
	20	□		MPS1-0920-L20C	185.7	220.7	223.7	264.7	263	1.7	10	2
	25	□		MPS1-0920-L25C	231.7	267.7	270.7	311.7	310	1.7	10	2
	30	□		MPS1-0920-L30C	277.7	315.7	318.7	359.7	358	1.7	10	2
35	□		MPS1-0920-L35C	323.7	362.7	364.7	405.7	404	1.7	10	2	
9.3	3	□		MPS1-0930S-DIN	32.7	46.7	47.7	88.7	87	1.7	10	4
	3	●		MPS1-0930S-DIN-C	32.7	46.7	47.7	88.7	87	1.7	10	2
	5	□		MPS1-0930L-DIN	46.7	60.7	61.7	102.7	101	1.7	10	4
	5	●		MPS1-0930L-DIN-C	46.7	60.7	61.7	102.7	101	1.7	10	2
	2	●		MPS1-0930-PC	20.1	41.5	44.5	90.5	89	1.5	10	2
	8	●		MPS1-0930-L8C	76.3	106.9	109.9	150.9	149	1.9	10	2
	10	□		MPS1-0930-L10C	94.7	125.7	128.7	169.7	168	1.7	10	2
	12	●		MPS1-0930-L12C	113.3	144.7	147.7	188.7	187	1.7	10	2
	15	□		MPS1-0930-L15C	141.2	172.7	175.7	216.7	215	1.7	10	2
	20	□		MPS1-0930-L20C	187.7	220.7	223.7	264.7	263	1.7	10	2
	25	□		MPS1-0930-L25C	234.2	267.7	270.7	311.7	310	1.7	10	2
	30	□		MPS1-0930-L30C	280.7	315.7	318.7	359.7	358	1.7	10	2
35	□		MPS1-0930-L35C	327.2	362.7	364.7	405.7	404	1.7	10	2	
9.4	3	□		MPS1-0940S-DIN	32.6	46.7	47.7	88.7	87	1.7	10	4
	3	●		MPS1-0940S-DIN-C	32.6	46.7	47.7	88.7	87	1.7	10	2
	5	□		MPS1-0940L-DIN	46.6	60.7	61.7	102.7	101	1.7	10	4
	5	●		MPS1-0940L-DIN-C	46.6	60.7	61.7	102.7	101	1.7	10	2
	2	●		MPS1-0940-PC	20.3	41.5	44.5	90.5	89	1.5	10	2
	8	●		MPS1-0940-L8C	77.1	106.9	109.9	150.9	149	1.9	10	2
	10	□		MPS1-0940-L10C	95.7	125.7	128.7	169.7	168	1.7	10	2
	12	●		MPS1-0940-L12C	114.5	144.7	147.7	188.7	187	1.7	10	2
	15	□		MPS1-0940-L15C	142.7	172.7	175.7	216.7	215	1.7	10	2
	20	□		MPS1-0940-L20C	189.7	220.7	223.7	264.7	263	1.7	10	2
	25	□		MPS1-0940-L25C	236.7	267.7	270.7	311.7	310	1.7	10	2
	30	□		MPS1-0940-L30C	283.7	315.7	318.7	359.7	358	1.7	10	2
35	□		MPS1-0940-L35C	330.7	362.7	364.7	405.7	404	1.7	10	2	
9.5	3	□		MPS1-0950S-DIN	32.5	46.7	47.7	88.7	87	1.7	10	4
	3	●		MPS1-0950S-DIN-C	32.5	46.7	47.7	88.7	87	1.7	10	2
	5	□		MPS1-0950L-DIN	46.5	60.7	61.7	102.7	101	1.7	10	4
	5	●		MPS1-0950L-DIN-C	46.5	60.7	61.7	102.7	101	1.7	10	2
	2	●		MPS1-0950-PC	20.5	41.5	44.5	90.5	89	1.5	10	2
	8	●		MPS1-0950-L8C	78.0	107.0	110.0	151.0	149	2.0	10	2
	10	□		MPS1-0950-L10C	96.7	125.7	128.7	169.7	168	1.7	10	2
	12	●		MPS1-0950-L12C	115.7	144.7	147.7	188.7	187	1.7	10	2
	15	●		MPS1-0950-L15C	144.2	172.7	175.7	216.7	215	1.7	10	2
	20	●		MPS1-0950-L20C	191.7	220.7	223.7	264.7	263	1.7	10	2
	25	●		MPS1-0950-L25C	239.2	267.7	270.7	311.7	310	1.7	10	2
	30	●		MPS1-0950-L30C	286.7	315.7	318.7	359.7	358	1.7	10	2
35	□		MPS1-0950-L35C	334.2	362.7	364.7	405.7	404	1.7	10	2	

DC	Bohrtiefe (mm)	Bohrtiefe (L/D)	DP1021	Bestellnummer	Abmessungen (mm)							Typ
					LU	LCF	LH	OAL	LF	PL	DCONMS	
9.6	3	□		MPS1-0960S-DIN	32.3	46.7	47.7	88.7	87	1.7	10	4
	3	●		MPS1-0960S-DIN-C	32.3	46.7	47.7	88.7	87	1.7	10	2
	5	□		MPS1-0960L-DIN	46.3	60.7	61.7	102.7	101	1.7	10	4
	5	●		MPS1-0960L-DIN-C	46.3	60.7	61.7	102.7	101	1.7	10	2
	2	●		MPS1-0960-PC	20.7	44.5	44.5	90.5	89	1.5	10	2
	8	●		MPS1-0960-L8C	78.8	112.0	115.0	156.0	154	2.0	10	2
	10	□		MPS1-0960-L10C	97.7	131.7	134.7	175.7	174	1.7	10	2
	12	●		MPS1-0960-L12C	116.9	151.7	154.7	195.7	194	1.7	10	2
	15	●		MPS1-0960-L15C	145.7	181.7	184.7	225.7	224	1.7	10	2
	20	□		MPS1-0960-L20C	193.7	231.7	234.7	275.7	274	1.7	10	2
	25	□		MPS1-0960-L25C	241.7	281.7	284.7	325.7	324	1.7	10	2
	30	□		MPS1-0960-L30C	289.7	331.7	334.7	375.7	374	1.7	10	2
35	□		MPS1-0960-L35C	337.7	381.7	383.7	424.7	423	1.7	10	2	
9.7	3	□		MPS1-0970S-DIN	32.2	46.8	47.8	88.8	87	1.8	10	4
	3	●		MPS1-0970S-DIN-C	32.2	46.8	47.8	88.8	87	1.8	10	2
	5	□		MPS1-0970L-DIN	46.2	60.8	61.8	102.8	101	1.8	10	4
	5	●		MPS1-0970L-DIN-C	46.2	60.8	61.8	102.8	101	1.8	10	2
	2	●		MPS1-0970-PC	20.9	44.5	44.5	90.5	89	1.5	10	2
	8	●		MPS1-0970-L8C	79.6	112.0	115.0	156.0	154	2.0	10	2
	10	□		MPS1-0970-L10C	98.8	131.8	134.8	175.8	174	1.8	10	2
	12	●		MPS1-0970-L12C	118.2	151.8	154.8	195.8	194	1.8	10	2
	15	●		MPS1-0970-L15C	147.3	181.8	184.8	225.8	224	1.8	10	2
	20	□		MPS1-0970-L20C	195.8	231.8	234.8	275.8	274	1.8	10	2
	25	□		MPS1-0970-L25C	244.3	281.8	284.8	325.8	324	1.8	10	2
	30	□		MPS1-0970-L30C	292.8	331.8	334.8	375.8	374	1.8	10	2
35	□		MPS1-0970-L35C	341.3	381.8	383.8	424.8	423	1.8	10	2	
9.8	3	□		MPS1-0980S-DIN	32.1	46.8	47.8	88.8	87	1.8	10	4
	3	●		MPS1-0980S-DIN-C	32.1	46.8	47.8	88.8	87	1.8	10	2
	5	□		MPS1-0980L-DIN	46.1	60.8	61.8	102.8	101	1.8	10	4
	5	●		MPS1-0980L-DIN-C	46.1	60.8	61.8	102.8	101	1.8	10	2
	2	●		MPS1-0980-PC	21.1	44.5	44.5	90.5	89	1.5	10	2
	8	●		MPS1-0980-L8C	80.4	112.0	115.0	156.0	154	2.0	10	2
	10	□		MPS1-0980-L10C	99.8	131.8	134.8	175.8	174	1.8	10	2
	12	●		MPS1-0980-L12C	119.4	151.8	154.8	195.8	194	1.8	10	2
	15	●		MPS1-0980-L15C	148.8	181.8	184.8	225.8	224	1.8	10	2
	20	●		MPS1-0980-L20C	197.8	231.8	234.8	275.8	274	1.8	10	2
	25	□		MPS1-0980-L25C	246.8	281.8	284.8	325.8	324	1.8	10	2
	30	●		MPS1-0980-L30C	295.8	331.8	334.8	375.8	374	1.8	10	2
35	□		MPS1-0980-L35C	344.8	381.8	383.8	424.8	423	1.8	10	2	
9.9	3	□		MPS1-0990S-DIN	32.0	46.8	47.8	88.8	87	1.8	10	4
	3	●		MPS1-0990S-DIN-C	32.0	46.8	47.8	88.8	87	1.8	10	2
	5	□		MPS1-0990L-DIN	46.0	60.8	61.8	102.8	101	1.8	10	4
	5	●		MPS1-0990L-DIN-C	46.0	60.8	61.8	102.8	101	1.8	10	2
	2	●		MPS1-0990-PC	21.4	44.6	44.6	90.6	89	1.6	10	2
	8	●		MPS1-0990-L8C	81.3	112.1	115.1	156.1	154	2.1	10	2
	10	□		MPS1-0990-L10C	100.8	131.8	134.8	175.8	174	1.8	10	2
	12	●		MPS1-0990-L12C	120.6	151.8	154.8	195.8	194	1.8	10	2
	15	●		MPS1-0990-L15C	150.3	181.8	184.8	225.8	224	1.8	10	2
	20	□		MPS1-0990-L20C	199.8	231.8	234.8	275.8	274	1.8	10	2
	25	□		MPS1-0990-L25C	249.3	281.8	284.8	325.8	324	1.8	10	2
	30	□		MPS1-0990-L30C	298.8	331.8	334.8	375.8	374	1.8	10	2
35	□		MPS1-0990-L35C	348.3	381.8	383.8	424.8	423	1.8	10	2	

● : Lagerstandard. □ : Herstellung nur auf Anfrage.



DC	Bohrtiefe (mm)	Bohrtiefe (L/D)	DP1021	Bestellnummer	Abmessungen (mm)							Typ
					LU	LCF	LH	OAL	LF	PL	DCONMS	
10.0	3	□		MPS1-1000S-DIN	31.8	46.8	47.8	88.8	87	1.8	10	4
	3	●		MPS1-1000S-DIN-C	31.8	46.8	47.8	88.8	87	1.8	10	2
	5	□		MPS1-1000L-DIN	45.8	60.8	61.8	102.8	101	1.8	10	4
	5	●		MPS1-1000L-DIN-C	45.8	60.8	61.8	102.8	101	1.8	10	2
	2	●		MPS1-1000-PC	21.6	44.6	44.6	90.6	89	1.6	10	2
	8	●		MPS1-1000-L8C	82.1	112.1	115.1	156.1	154	2.1	10	2
	10	●		MPS1-1000-L10C	101.8	131.8	134.8	175.8	174	1.8	10	2
	12	●		MPS1-1000-L12C	121.8	151.8	154.8	195.8	194	1.8	10	2
	15	●		MPS1-1000-L15C	151.8	181.8	184.8	225.8	224	1.8	10	2
	20	●		MPS1-1000-L20C	201.8	231.8	234.8	275.8	274	1.8	10	2
	25	●		MPS1-1000-L25C	251.8	281.8	284.8	325.8	324	1.8	10	2
	30	●		MPS1-1000-L30C	301.8	331.8	334.8	375.8	374	1.8	10	2
	35	□		MPS1-1000-L35C	351.8	381.8	383.8	424.8	423	1.8	10	2
	10.05	3	□		MPS1-1005S-DIN	39.8	54.8	55.8	101.8	100	1.8	12
3		●		MPS1-1005S-DIN-C	39.8	54.8	55.8	101.8	100	1.8	12	2
5		□		MPS1-1005L-DIN	55.8	70.8	71.8	117.8	116	1.8	12	4
5		●		MPS1-1005L-DIN-C	55.8	70.8	71.8	117.8	116	1.8	12	2
5		□		MPS1-1010S-DIN	39.7	54.8	55.8	101.8	100	1.8	12	4
10.1	3	●		MPS1-1010S-DIN-C	39.7	54.8	55.8	101.8	100	1.8	12	2
	5	□		MPS1-1010L-DIN	55.7	70.8	71.8	117.8	116	1.8	12	4
	5	●		MPS1-1010L-DIN-C	55.7	70.8	71.8	117.8	116	1.8	12	2
	2	●		MPS1-1010-PC	21.8	44.6	47.6	96.6	95	1.6	12	2
	8	●		MPS1-1010-L8C	82.9	118.1	121.1	167.1	165	2.1	12	2
	10	□		MPS1-1010-L10C	102.8	138.8	141.8	187.8	186	1.8	12	2
	12	●		MPS1-1010-L12C	123.0	159.8	162.8	208.8	207	1.8	12	2
	15	●		MPS1-1010-L15C	153.3	190.8	193.8	239.8	238	1.8	12	2
	20	●		MPS1-1010-L20C	203.8	243.8	246.8	292.8	291	1.8	12	2
	25	□		MPS1-1010-L25C	254.3	295.8	298.8	344.8	343	1.8	12	2
	10.2	3	□		MPS1-1020S-DIN	39.6	54.9	55.9	101.9	100	1.9	12
3		●		MPS1-1020S-DIN-C	39.6	54.9	55.9	101.9	100	1.9	12	2
5		□		MPS1-1020L-DIN	55.6	70.9	71.9	117.9	116	1.9	12	4
5		●		MPS1-1020L-DIN-C	55.6	70.9	71.9	117.9	116	1.9	12	2
2		●		MPS1-1020-PC	22.0	44.6	47.6	96.6	95	1.6	12	2
8		●		MPS1-1020-L8C	83.7	118.1	121.1	167.1	165	2.1	12	2
10		□		MPS1-1020-L10C	103.9	138.9	141.9	187.9	186	1.9	12	2
12		●		MPS1-1020-L12C	124.3	159.9	162.9	208.9	207	1.9	12	2
15		●		MPS1-1020-L15C	154.9	190.9	193.9	239.9	238	1.9	12	2
20		●		MPS1-1020-L20C	205.9	243.9	246.9	292.9	291	1.9	12	2
25		□		MPS1-1020-L25C	256.9	295.9	298.9	344.9	343	1.9	12	2
10.3	3	□		MPS1-1030S-DIN	39.4	54.9	55.9	101.9	100	1.9	12	4
	3	●		MPS1-1030S-DIN-C	39.4	54.9	55.9	101.9	100	1.9	12	2
	5	□		MPS1-1030L-DIN	55.4	70.9	71.9	117.9	116	1.9	12	4
	5	●		MPS1-1030L-DIN-C	55.4	70.9	71.9	117.9	116	1.9	12	2
	2	●		MPS1-1030-PC	22.2	44.6	47.6	96.6	95	1.6	12	2
	8	●		MPS1-1030-L8C	84.5	118.1	121.1	167.1	165	2.1	12	2
	10	□		MPS1-1030-L10C	104.9	138.9	141.9	187.9	186	1.9	12	2
	12	●		MPS1-1030-L12C	125.5	159.9	162.9	208.9	207	1.9	12	2
	15	□		MPS1-1030-L15C	156.4	190.9	193.9	239.9	238	1.9	12	2
	20	□		MPS1-1030-L20C	207.9	243.9	246.9	292.9	291	1.9	12	2
	25	□		MPS1-1030-L25C	259.4	295.9	298.9	344.9	343	1.9	12	2

DC	Bohrtiefe (mm)	Bohrtiefe (L/D)	DP1021	Bestellnummer	Abmessungen (mm)							Typ
					LU	LCF	LH	OAL	LF	PL	DCONMS	
10.4	3	□		MPS1-1040S-DIN	39.3	54.9	55.9	101.9	100	1.9	12	4
	3	●		MPS1-1040S-DIN-C	39.3	54.9	55.9	101.9	100	1.9	12	2
	5	□		MPS1-1040L-DIN	55.3	70.9	71.9	117.9	116	1.9	12	4
	5	●		MPS1-1040L-DIN-C	55.3	70.9	71.9	117.9	116	1.9	12	2
	2	●		MPS1-1040-PC	22.4	44.6	47.6	96.6	95	1.6	12	2
	8	●		MPS1-1040-L8C	85.4	118.2	121.2	167.2	165	2.2	12	2
	10	□		MPS1-1040-L10C	105.9	138.9	141.9	187.9	186	1.9	12	2
	12	●		MPS1-1040-L12C	126.7	159.9	162.9	208.9	207	1.9	12	2
	15	□		MPS1-1040-L15C	157.9	190.9	193.9	239.9	238	1.9	12	2
	20	□		MPS1-1040-L20C	209.9	243.9	246.9	292.9	291	1.9	12	2
	25	□		MPS1-1040-L25C	261.9	295.9	298.9	344.9	343	1.9	12	2
10.5	3	□		MPS1-1050S-DIN	39.2	54.9	55.9	101.9	100	1.9	12	4
	3	●		MPS1-1050S-DIN-C	39.2	54.9	55.9	101.9	100	1.9	12	2
	5	□		MPS1-1050L-DIN	55.2	70.9	71.9	117.9	116	1.9	12	4
	5	●		MPS1-1050L-DIN-C	55.2	70.9	71.9	117.9	116	1.9	12	2
	2	●		MPS1-1050-PC	22.7	44.7	47.7	96.7	95	1.7	12	2
	8	●		MPS1-1050-L8C	86.2	118.2	121.2	167.2	165	2.2	12	2
	10	□		MPS1-1050-L10C	106.9	138.9	141.9	187.9	186	1.9	12	2
	12	●		MPS1-1050-L12C	127.9	159.9	162.9	208.9	207	1.9	12	2
	15	●		MPS1-1050-L15C	159.4	190.9	193.9	239.9	238	1.9	12	2
	20	●		MPS1-1050-L20C	211.9	243.9	246.9	292.9	291	1.9	12	2
	25	●		MPS1-1050-L25C	264.4	295.9	298.9	344.9	343	1.9	12	2
10.6	3	□		MPS1-1060S-DIN	39.0	54.9	55.9	101.9	100	1.9	12	4
	3	●		MPS1-1060S-DIN-C	39.0	54.9	55.9	101.9	100	1.9	12	2
	5	□		MPS1-1060L-DIN	55.0	70.9	71.9	117.9	116	1.9	12	4
	5	●		MPS1-1060L-DIN-C	55.0	70.9	71.9	117.9	116	1.9	12	2
	2	□		MPS1-1060-PC	22.9	48.7	49.7	96.7	95	1.7	12	2
	8	●		MPS1-1060-L8C	87.0	123.2	126.2	172.2	170	2.2	12	2
	10	□		MPS1-1060-L10C	107.9	144.9	147.9	193.9	192	1.9	12	2
	12	□		MPS1-1060-L12C	129.1	166.9	169.9	215.9	214	1.9	12	2
	15	□		MPS1-1060-L15C	160.9	199.9	202.9	248.9	247	1.9	12	2
	20	□		MPS1-1060-L20C	213.9	254.9	257.9	303.9	302	1.9	12	2
	25	□		MPS1-1060-L25C	266.9	309.9	312.9	358.9	357	1.9	12	2
10.7	3	□		MPS1-1070S-DIN	38.9	54.9	55.9	101.9	100	1.9	12	4
	3	●		MPS1-1070S-DIN-C	38.9	54.9	55.9	101.9	100	1.9	12	2
	5	□		MPS1-1070L-DIN	54.9	70.9	71.9	117.9	116	1.9	12	4
	5	●		MPS1-1070L-DIN-C	54.9	70.9	71.9	117.9	116	1.9	12	2
	2	●		MPS1-1070-PC	23.1	48.7	49.7	96.7	95	1.7	12	2
	8	●		MPS1-1070-L8C	87.8	123.2	126.2	172.2	170	2.2	12	2
	10	□		MPS1-1070-L10C	108.9	144.9	147.9	193.9	192	1.9	12	2
	12	●		MPS1-1070-L12C	130.3	166.9	169.9	215.9	214	1.9	12	2
	15	□		MPS1-1070-L15C	162.4	199.9	202.9	248.9	247	1.9	12	2
	20	□		MPS1-1070-L20C	215.9	254.9	257.9	303.9	302	1.9	12	2
	25	□		MPS1-1070-L25C	269.4	309.9	312.9	358.9	357	1.9	12	2
10.8	3	□		MPS1-1080S-DIN	38.8	55.0	56.0	102.0	100	2.0	12	4
	3	●		MPS1-1080S-DIN-C	38.8	55.0	56.0	102.0	100	2.0	12	2
	5	□		MPS1-1080L-DIN	54.8	71.0	72.0	118.0	116	2.0	12	4
	5	●		MPS1-1080L-DIN-C	54.8	71.0	72.0	118.0	116	2.0	12	2
	2	●		MPS1-1080-PC	23.3	48.7	49.7	96.7	95	1.7	12	2
	8	●		MPS1-1080-L8C	88.6	123.2	126.2	172.2	170	2.2	12	2
	10	□		MPS1-1080-L10C	110.0	145.0	148.0	194.0	192	2.0	12	2
	12	●		MPS1-1080-L12C	131.6	167.0	170.0	216.0	214	2.0	12	2
	15	□		MPS1-1080-L15C	164.0	200.0	203.0	249.0	247	2.0	12	2
	20	□		MPS1-1080-L20C	218.0	255.0	258.0	304.0	302	2.0	12	2
	25	□		MPS1-1080-L25C	272.0	310.0	313.0	359.0	357	2.0	12	2

# BOHREN (VOLLHARTMETALL)

## MPS1

4-Fasen & Super Long-VHM-Bohrer

HARTMETALL

M  
BOHREN

DC	Bohrtiefe (mm)	Bohrtiefe (L/D)	DP1021	Bestellnummer	Abmessungen (mm)							Typ
					LU	LCF	LH	OAL	LF	PL	DCONMS	
10.9	3	□	●	MPS1-1090S-DIN	38.6	55.0	56.0	102.0	100	2.0	12	4
	3	●	●	MPS1-1090S-DIN-C	38.6	55.0	56.0	102.0	100	2.0	12	2
	5	□	□	MPS1-1090L-DIN	54.6	71.0	72.0	118.0	116	2.0	12	4
	5	●	●	MPS1-1090L-DIN-C	54.6	71.0	72.0	118.0	116	2.0	12	2
	2	□	□	MPS1-1090-PC	23.5	48.7	49.7	96.7	95	1.7	12	2
	8	●	●	MPS1-1090-L8C	89.5	123.3	126.3	172.3	170	2.3	12	2
	10	□	□	MPS1-1090-L10C	111.0	145.0	148.0	194.0	192	2.0	12	2
	12	□	□	MPS1-1090-L12C	132.8	167.0	170.0	216.0	214	2.0	12	2
	15	□	□	MPS1-1090-L15C	165.5	200.0	203.0	249.0	247	2.0	12	2
	20	□	□	MPS1-1090-L20C	220.0	255.0	258.0	304.0	302	2.0	12	2
25	□	□	MPS1-1090-L25C	274.5	310.0	313.0	359.0	357	2.0	12	2	
11.0	3	□	●	MPS1-1100S-DIN	38.5	55.0	56.0	102.0	100	2.0	12	4
	3	●	●	MPS1-1100S-DIN-C	38.5	55.0	56.0	102.0	100	2.0	12	2
	5	□	□	MPS1-1100L-DIN	54.5	71.0	72.0	118.0	116	2.0	12	4
	5	●	●	MPS1-1100L-DIN-C	54.5	71.0	72.0	118.0	116	2.0	12	2
	2	●	●	MPS1-1100-PC	23.7	48.7	49.7	96.7	95	1.7	12	2
	8	●	●	MPS1-1100-L8C	90.3	123.3	126.3	172.3	170	2.3	12	2
	10	□	□	MPS1-1100-L10C	112.0	145.0	148.0	194.0	192	2.0	12	2
	12	●	●	MPS1-1100-L12C	134.0	167.0	170.0	216.0	214	2.0	12	2
	15	●	●	MPS1-1100-L15C	167.0	200.0	203.0	249.0	247	2.0	12	2
	20	●	●	MPS1-1100-L20C	222.0	255.0	258.0	304.0	302	2.0	12	2
25	●	●	MPS1-1100-L25C	277.0	310.0	313.0	359.0	357	2.0	12	2	
11.1	3	□	●	MPS1-1110S-DIN	38.4	55.0	56.0	102.0	100	2.0	12	4
	3	●	●	MPS1-1110S-DIN-C	38.4	55.0	56.0	102.0	100	2.0	12	2
	5	□	□	MPS1-1110L-DIN	54.4	71.0	72.0	118.0	116	2.0	12	4
	5	●	●	MPS1-1110L-DIN-C	54.4	71.0	72.0	118.0	116	2.0	12	2
	2	●	●	MPS1-1110-PC	23.9	48.7	51.7	96.7	95	1.7	12	2
	8	●	●	MPS1-1110-L8C	91.1	129.3	132.3	178.3	176	2.3	12	2
	10	□	□	MPS1-1110-L10C	113.0	152.0	155.0	201.0	199	2.0	12	2
	12	●	●	MPS1-1110-L12C	135.2	175.0	178.0	224.0	222	2.0	12	2
	15	●	●	MPS1-1110-L15C	168.5	209.0	212.0	258.0	256	2.0	12	2
	20	□	□	MPS1-1110-L20C	224.0	267.0	270.0	316.0	314	2.0	12	2
25	●	●	MPS1-1110-L25C	279.5	324.0	327.0	373.0	371	2.0	12	2	
11.2	3	□	●	MPS1-1120S-DIN	38.2	55.0	56.0	102.0	100	2.0	12	4
	3	●	●	MPS1-1120S-DIN-C	38.2	55.0	56.0	102.0	100	2.0	12	2
	5	□	□	MPS1-1120L-DIN	54.2	71.0	72.0	118.0	116	2.0	12	4
	5	●	●	MPS1-1120L-DIN-C	54.2	71.0	72.0	118.0	116	2.0	12	2
	2	●	●	MPS1-1120-PC	24.2	48.8	51.8	96.8	95	1.8	12	2
	8	●	●	MPS1-1120-L8C	91.9	129.3	132.3	178.3	176	2.3	12	2
	10	□	□	MPS1-1120-L10C	114.0	152.0	155.0	201.0	199	2.0	12	2
	12	□	□	MPS1-1120-L12C	136.4	175.0	178.0	224.0	222	2.0	12	2
	15	●	●	MPS1-1120-L15C	170.0	209.0	212.0	258.0	256	2.0	12	2
	20	□	□	MPS1-1120-L20C	226.0	267.0	270.0	316.0	314	2.0	12	2
25	□	□	MPS1-1120-L25C	282.0	324.0	327.0	373.0	371	2.0	12	2	
11.3	3	□	●	MPS1-1130S-DIN	38.1	55.1	56.1	102.1	100	2.1	12	4
	3	●	●	MPS1-1130S-DIN-C	38.1	55.1	56.1	102.1	100	2.1	12	2
	5	□	□	MPS1-1130L-DIN	54.1	71.1	72.1	118.1	116	2.1	12	4
	5	●	●	MPS1-1130L-DIN-C	54.1	71.1	72.1	118.1	116	2.1	12	2
	2	□	□	MPS1-1130-PC	24.4	48.8	51.8	96.8	95	1.8	12	2
	8	●	●	MPS1-1130-L8C	92.7	129.3	132.3	178.3	176	2.3	12	2
	10	□	□	MPS1-1130-L10C	115.1	152.1	155.1	201.1	199	2.1	12	2
	12	□	□	MPS1-1130-L12C	137.7	175.1	178.1	224.1	222	2.1	12	2
	15	□	□	MPS1-1130-L15C	171.6	209.1	212.1	258.1	256	2.1	12	2
	20	□	□	MPS1-1130-L20C	228.1	267.1	270.1	316.1	314	2.1	12	2
25	□	□	MPS1-1130-L25C	284.6	324.1	327.1	373.1	371	2.1	12	2	

DC	Bohrtiefe (mm)	Bohrtiefe (L/D)	DP1021	Bestellnummer	Abmessungen (mm)							Typ
					LU	LCF	LH	OAL	LF	PL	DCONMS	
11.4	3	□	●	MPS1-1140S-DIN	38.0	55.1	56.1	102.1	100	2.1	12	4
	3	●	●	MPS1-1140S-DIN-C	38.0	55.1	56.1	102.1	100	2.1	12	2
	5	□	□	MPS1-1140L-DIN	54.0	71.1	72.1	118.1	116	2.1	12	4
	5	●	●	MPS1-1140L-DIN-C	54.0	71.1	72.1	118.1	116	2.1	12	2
	2	□	□	MPS1-1140-PC	24.6	48.8	51.8	96.8	95	1.8	12	2
	8	●	●	MPS1-1140-L8C	93.6	129.4	132.4	178.4	176	2.4	12	2
	10	□	□	MPS1-1140-L10C	116.1	152.1	155.1	201.1	199	2.1	12	2
	12	□	□	MPS1-1140-L12C	138.9	175.1	178.1	224.1	222	2.1	12	2
	15	□	□	MPS1-1140-L15C	173.1	209.1	212.1	258.1	256	2.1	12	2
	20	□	□	MPS1-1140-L20C	230.1	267.1	270.1	316.1	314	2.1	12	2
25	□	□	MPS1-1140-L25C	287.1	324.1	327.1	373.1	371	2.1	12	2	
11.5	3	□	●	MPS1-1150S-DIN	37.8	55.1	56.1	102.1	100	2.1	12	4
	3	●	●	MPS1-1150S-DIN-C	37.8	55.1	56.1	102.1	100	2.1	12	2
	5	□	□	MPS1-1150L-DIN	53.8	71.1	72.1	118.1	116	2.1	12	4
	5	●	●	MPS1-1150L-DIN-C	53.8	71.1	72.1	118.1	116	2.1	12	2
	2	●	●	MPS1-1150-PC	24.8	48.8	51.8	96.8	95	1.8	12	2
	8	●	●	MPS1-1150-L8C	94.4	129.4	132.4	178.4	176	2.4	12	2
	10	□	□	MPS1-1150-L10C	117.1	152.1	155.1	201.1	199	2.1	12	2
	12	●	●	MPS1-1150-L12C	140.1	175.1	178.1	224.1	222	2.1	12	2
	15	●	●	MPS1-1150-L15C	174.6	209.1	212.1	258.1	256	2.1	12	2
	20	●	●	MPS1-1150-L20C	232.1	267.1	270.1	316.1	314	2.1	12	2
25	●	●	MPS1-1150-L25C	289.6	324.1	327.1	373.1	371	2.1	12	2	
11.6	3	□	●	MPS1-1160S-DIN	37.7	55.1	56.1	102.1	100	2.1	12	4
	3	●	●	MPS1-1160S-DIN-C	37.7	55.1	56.1	102.1	100	2.1	12	2
	5	□	□	MPS1-1160L-DIN	53.7	71.1	72.1	118.1	116	2.1	12	4
	5	●	●	MPS1-1160L-DIN-C	53.7	71.1	72.1	118.1	116	2.1	12	2
	2	□	□	MPS1-1160-PC	25.0	48.8	48.8	96.8	95	1.8	12	2
	8	●	●	MPS1-1160-L8C	95.2	134.4	137.4	183.4	181	2.4	12	2
	10	□	□	MPS1-1160-L10C	118.1	158.1	161.1	207.1	205	2.1	12	2
	12	□	□	MPS1-1160-L12C	141.3	182.1	185.1	231.1	229	2.1	12	2
	15	□	□	MPS1-1160-L15C	176.1	218.1	221.1	267.1	265	2.1	12	2
	20	□	□	MPS1-1160-L20C	234.1	278.1	281.1	327.1	325	2.1	12	2
25	□	□	MPS1-1160-L25C	292.1	338.1	341.1	387.1	385	2.1	12	2	
11.7	3	□	●	MPS1-1170S-DIN	37.6	55.1	56.1	102.1	100	2.1	12	4
	3	●	●	MPS1-1170S-DIN-C	37.6	55.1	56.1	102.1	100	2.1	12	2
	5	□	□	MPS1-1170L-DIN	53.6	71.1	72.1	118.1	116	2.1	12	4
	5	●	●	MPS1-1170L-DIN-C	53.6	71.1	72.1	118.1	116	2.1	12	2
	2	●	●	MPS1-1170-PC	25.2	48.8	48.8	96.8	95	1.8	12	2
	8	●	●	MPS1-1170-L8C	96.0	134.4	137.4	183.4	181	2.4	12	2
	10	□	□	MPS1-1170-L10C	119.1	158.1	161.1	207.1	205	2.1	12	2
	12	●	●	MPS1-1170-L12C	142.5	182.1	185.1	231.1	229	2.1	12	2
	15	●	●	MPS1-1170-L15C	177.6	218.1	221.1	267.1	265	2.1	12	2
	20	□	□	MPS1-1170-L20C	236.1	278.1	281.1	327.1	325	2.1	12	2
25	□	□	MPS1-1170-L25C	294.6	338.1	341.1	387.1	385	2.1	12	2	
11.8	3	□	●	MPS1-1180S-DIN	37.4	55.1	56.1	102.1	100	2.1	12	4
	3	●	●	MPS1-1180S-DIN-C	37.4	55.1	56.1	102.1	100	2.1	12	2
	5	□	□	MPS1-1180L-DIN	53.4	71.1	72.1	118.1	116	2.1	12	4
	5	●	●	MPS1-1180L-DIN-C	53.4	71.1	72.1	118.1	116	2.1	12	2
	2	●	●	MPS1-1180-PC	25.5	48.9	48.9	96.9	95	1.9	12	2
	8	●	●	MPS1-1180-L8C	96.8	134.4	137.4	183.4	181	2.4	12	2
	10	□	□	MPS1-1180-L10C	120.1	158.1	161.1	207.1	205	2.1	12	2
	12	●	●	MPS1-1180-L12C	143.7	182.1	185.1	231.1	229	2.1	12	2
	15	●	●	MPS1-1180-L15C	179.1	218.1	221.1	267.1	265	2.1	12	2
	20	□	□	MPS1-1180-L20C	238.1	278.1	281.1	327.1	325	2.1	12	2
25	□	□	MPS1-1180-L25									

DC	Bohrtiefe (mm)	DP1021 (L/D)	Bestellnummer	Abmessungen (mm)								Typ
				LU	LCF	LH	OAL	LF	PL	DCONMS		
11.9	3	□	MPS1-1190S-DIN	37.3	55.2	56.2	102.2	100	2.2	12	4	
	3	●	MPS1-1190S-DIN-C	37.3	55.2	56.2	102.2	100	2.2	12	2	
	5	□	MPS1-1190L-DIN	53.3	71.2	72.2	118.2	116	2.2	12	4	
	5	●	MPS1-1190L-DIN-C	53.3	71.2	72.2	118.2	116	2.2	12	2	
	2	□	MPS1-1190-PC	25.7	48.9	48.9	96.9	95	1.9	12	2	
	8	●	MPS1-1190-L8C	97.7	134.5	137.5	183.5	181	2.5	12	2	
	10	□	MPS1-1190-L10C	121.2	158.2	161.2	207.2	205	2.2	12	2	
	12	□	MPS1-1190-L12C	145.0	182.2	185.2	231.2	229	2.2	12	2	
	15	□	MPS1-1190-L15C	180.7	218.2	221.2	267.2	265	2.2	12	2	
	20	□	MPS1-1190-L20C	240.2	278.2	281.2	327.2	325	2.2	12	2	
	25	□	MPS1-1190-L25C	299.7	338.2	341.2	387.2	385	2.2	12	2	
	12.0	3	□	MPS1-1200S-DIN	37.2	55.2	56.2	102.2	100	2.2	12	4
3		●	MPS1-1200S-DIN-C	37.2	55.2	56.2	102.2	100	2.2	12	2	
5		□	MPS1-1200L-DIN	53.2	71.2	72.2	118.2	116	2.2	12	4	
5		●	MPS1-1200L-DIN-C	53.2	71.2	72.2	118.2	116	2.2	12	2	
2		●	MPS1-1200-PC	25.9	48.9	48.9	96.9	95	1.9	12	2	
8		●	MPS1-1200-L8C	98.5	134.5	137.5	183.5	181	2.5	12	2	
10		□	MPS1-1200-L10C	122.2	158.2	161.2	207.2	205	2.2	12	2	
12		●	MPS1-1200-L12C	146.2	182.2	185.2	231.2	229	2.2	12	2	
15		●	MPS1-1200-L15C	182.2	218.2	221.2	267.2	265	2.2	12	2	
20		●	MPS1-1200-L20C	242.2	278.2	281.2	327.2	325	2.2	12	2	
25		●	MPS1-1200-L25C	302.2	338.2	341.2	387.2	385	2.2	12	2	
12.05		3	□	MPS1-1205S-DIN	42.1	60.2	61.2	107.2	105	2.2	14	4
	3	●	MPS1-1205S-DIN-C	42.1	60.2	61.2	107.2	105	2.2	14	2	
	5	□	MPS1-1205L-DIN	59.1	77.2	78.2	124.2	122	2.2	14	4	
	5	●	MPS1-1205L-DIN-C	59.1	77.2	78.2	124.2	122	2.2	14	2	
12.1	3	□	MPS1-1210S-DIN	42.1	60.2	61.2	107.2	105	2.2	14	4	
	3	●	MPS1-1210S-DIN-C	42.1	60.2	61.2	107.2	105	2.2	14	2	
	5	□	MPS1-1210L-DIN	59.1	77.2	78.2	124.2	122	2.2	14	4	
	5	●	MPS1-1210L-DIN-C	59.1	77.2	78.2	124.2	122	2.2	14	2	
	2	●	MPS1-1210-PC	26.1	52.9	55.9	103.9	102	1.9	14	2	
	8	●	MPS1-1210-L8C	99.3	140.5	143.5	189.5	187	2.5	14	2	
	10	□	MPS1-1210-L10C	123.2	165.2	168.2	214.2	212	2.2	14	2	
	12	●	MPS1-1210-L12C	147.4	190.2	193.2	239.2	237	2.2	14	2	
	15	●	MPS1-1210-L15C	183.7	227.2	230.2	276.2	274	2.2	14	2	
	20	□	MPS1-1210-L20C	244.2	290.2	293.2	339.2	337	2.2	14	2	
12.2	3	□	MPS1-1220S-DIN	41.9	60.2	61.2	107.2	105	2.2	14	4	
	3	●	MPS1-1220S-DIN-C	41.9	60.2	61.2	107.2	105	2.2	14	2	
	5	□	MPS1-1220L-DIN	58.9	77.2	78.2	124.2	122	2.2	14	4	
	5	●	MPS1-1220L-DIN-C	58.9	77.2	78.2	124.2	122	2.2	14	2	
	2	●	MPS1-1220-PC	26.3	52.9	55.9	103.9	102	1.9	14	2	
	8	●	MPS1-1220-L8C	100.1	140.5	143.5	189.5	187	2.5	14	2	
	10	□	MPS1-1220-L10C	124.2	165.2	168.2	214.2	212	2.2	14	2	
	12	●	MPS1-1220-L12C	148.6	190.2	193.2	239.2	237	2.2	14	2	
	15	●	MPS1-1220-L15C	185.2	227.2	230.2	276.2	274	2.2	14	2	
	20	□	MPS1-1220-L20C	246.2	290.2	293.2	339.2	337	2.2	14	2	
12.3	3	□	MPS1-1230S-DIN	41.8	60.2	61.2	107.2	105	2.2	14	4	
	3	●	MPS1-1230S-DIN-C	41.8	60.2	61.2	107.2	105	2.2	14	2	
	5	□	MPS1-1230L-DIN	58.8	77.2	78.2	124.2	122	2.2	14	4	
	5	●	MPS1-1230L-DIN-C	58.8	77.2	78.2	124.2	122	2.2	14	2	
	2	□	MPS1-1230-PC	26.5	52.9	55.9	103.9	102	1.9	14	2	
	8	●	MPS1-1230-L8C	100.9	140.5	143.5	189.5	187	2.5	14	2	
	10	□	MPS1-1230-L10C	125.2	165.2	168.2	214.2	212	2.2	14	2	
	12	□	MPS1-1230-L12C	149.8	190.2	193.2	239.2	237	2.2	14	2	
	15	□	MPS1-1230-L15C	186.7	227.2	230.2	276.2	274	2.2	14	2	
	20	□	MPS1-1230-L20C	248.2	290.2	293.2	339.2	337	2.2	14	2	

DC	Bohrtiefe (mm)	DP1021 (L/D)	Bestellnummer	Abmessungen (mm)								Typ
				LU	LCF	LH	OAL	LF	PL	DCONMS		
12.4	3	□	MPS1-1240S-DIN	41.7	60.3	61.3	107.3	105	2.3	14	4	
	3	●	MPS1-1240S-DIN-C	41.7	60.3	61.3	107.3	105	2.3	14	2	
	5	□	MPS1-1240L-DIN	58.7	77.3	78.3	124.3	122	2.3	14	4	
	5	●	MPS1-1240L-DIN-C	58.7	77.3	78.3	124.3	122	2.3	14	2	
	2	□	MPS1-1240-PC	26.8	53.0	56.0	104.0	102	2.0	14	2	
	8	●	MPS1-1240-L8C	101.8	140.6	143.6	189.6	187	2.6	14	2	
	10	□	MPS1-1240-L10C	126.3	165.3	168.3	214.3	212	2.3	14	2	
	12	□	MPS1-1240-L12C	151.1	190.3	193.3	239.3	237	2.3	14	2	
	15	□	MPS1-1240-L15C	188.3	227.3	230.3	276.3	274	2.3	14	2	
	20	□	MPS1-1240-L20C	250.3	290.3	293.3	339.3	337	2.3	14	2	
12.5	3	□	MPS1-1250S-DIN	41.5	60.3	61.3	107.3	105	2.3	14	4	
	3	●	MPS1-1250S-DIN-C	41.5	60.3	61.3	107.3	105	2.3	14	2	
	5	□	MPS1-1250L-DIN	58.5	77.3	78.3	124.3	122	2.3	14	4	
	5	●	MPS1-1250L-DIN-C	58.5	77.3	78.3	124.3	122	2.3	14	2	
	2	●	MPS1-1250-PC	27.0	53.0	56.0	104.0	102	2.0	14	2	
	8	●	MPS1-1250-L8C	102.6	140.6	143.6	189.6	187	2.6	14	2	
	10	□	MPS1-1250-L10C	127.3	165.3	168.3	214.3	212	2.3	14	2	
	12	●	MPS1-1250-L12C	152.3	190.3	193.3	239.3	237	2.3	14	2	
12.6	15	●	MPS1-1250-L15C	189.8	227.3	230.3	276.3	274	2.3	14	2	
	20	□	MPS1-1250-L20C	252.3	290.3	293.3	339.3	337	2.3	14	2	
	3	□	MPS1-1260S-DIN	41.4	60.3	61.3	107.3	105	2.3	14	4	
	3	●	MPS1-1260S-DIN-C	41.4	60.3	61.3	107.3	105	2.3	14	2	
	5	□	MPS1-1260L-DIN	58.4	77.3	78.3	124.3	122	2.3	14	4	
	5	●	MPS1-1260L-DIN-C	58.4	77.3	78.3	124.3	122	2.3	14	2	
	2	□	MPS1-1260-PC	27.2	53.0	55.0	104.0	102	2.0	14	2	
	8	●	MPS1-1260-L8C	103.4	145.6	148.6	194.6	192	2.6	14	2	
12.7	10	□	MPS1-1260-L10C	128.3	171.3	174.3	220.3	218	2.3	14	2	
	12	□	MPS1-1260-L12C	153.5	197.3	200.3	246.3	244	2.3	14	2	
	15	□	MPS1-1260-L15C	191.3	236.3	239.3	285.3	283	2.3	14	2	
	20	□	MPS1-1260-L20C	254.3	301.3	304.3	350.3	348	2.3	14	2	
	3	□	MPS1-1270S-DIN	41.3	60.3	61.3	107.3	105	2.3	14	4	
	3	●	MPS1-1270S-DIN-C	41.3	60.3	61.3	107.3	105	2.3	14	2	
	5	□	MPS1-1270L-DIN	58.3	77.3	78.3	124.3	122	2.3	14	4	
	5	●	MPS1-1270L-DIN-C	58.3	77.3	78.3	124.3	122	2.3	14	2	
12.8	2	●	MPS1-1270-PC	27.4	53.0	55.0	104.0	102	2.0	14	2	
	8	●	MPS1-1270-L8C	104.2	145.6	148.6	194.6	192	2.6	14	2	
	10	□	MPS1-1270-L10C	129.3	171.3	174.3	220.3	218	2.3	14	2	
	12	●	MPS1-1270-L12C	154.7	197.3	200.3	246.3	244	2.3	14	2	
	15	□	MPS1-1270-L15C	192.8	236.3	239.3	285.3	283	2.3	14	2	
	20	□	MPS1-1270-L20C	256.3	301.3	304.3	350.3	348	2.3	14	2	
	3	□	MPS1-1280S-DIN	41.1	60.3	61.3	107.3	105	2.3	14	4	
	3	●	MPS1-1280S-DIN-C	41.1	60.3	61.3	107.3	105	2.3	14	2	
12.9	5	□	MPS1-1280L-DIN	58.1	77.3	78.3	124.3	122	2.3	14	4	
	5	●	MPS1-1280L-DIN-C	58.1	77.3	78.3	124.3	122	2.3	14	2	
	2	●	MPS1-1280-PC	27.6	53.0	55.0	104.0	102	2.0	14	2	
	8	●	MPS1-1280-L8C	105.1	145.7	148.7	194.7	192	2.7	14	2	
	10	□	MPS1-1280-L10C	130.3	171.3	174.3	220.3	218	2.3	14	2	
	12	●	MPS1-1280-L12C	155.9	197.3	200.3	246.3	244	2.3	14	2	
	15	□	MPS1-1280-L15C	194.3	236.3	239.3	285.3	283	2.3	14	2	
	20	□	MPS1-1280-L20C	258.3	301.3	304.3	350.3	348	2.3	14	2	

# BOHREN (VOLLHARTMETALL)

## MPS1

4-Fasen & Super Long-VHM-Bohrer

HARTMETALL

M

BOHREN

DC	Bohrtiefe (mm)	Bohrtiefe (L/D)	DP1021	Bestellnummer	Abmessungen (mm)							Typ
					LU	LCF	LH	OAL	LF	PL	DCONMS	
12.9	3	□		MPS1-1290S-DIN	41.0	60.3	61.3	107.3	105	2.3	14	4
	3	●		MPS1-1290S-DIN-C	41.0	60.3	61.3	107.3	105	2.3	14	2
	5	□		MPS1-1290L-DIN	58.0	77.3	78.3	124.3	122	2.3	14	4
	5	●		MPS1-1290L-DIN-C	58.0	77.3	78.3	124.3	122	2.3	14	2
	2	□		MPS1-1290-PC	27.8	53.0	55.0	104.0	102	2.0	14	2
	8	●		MPS1-1290-L8C	105.9	145.7	148.7	194.7	192	2.7	14	2
	10	□		MPS1-1290-L10C	131.3	171.3	174.3	220.3	218	2.3	14	2
	12	□		MPS1-1290-L12C	157.1	197.3	200.3	246.3	244	2.3	14	2
	15	□		MPS1-1290-L15C	195.8	236.3	239.3	285.3	283	2.3	14	2
	20	□		MPS1-1290-L20C	260.3	301.3	304.3	350.3	348	2.3	14	2
13.0	3	□		MPS1-1300S-DIN	40.9	60.4	61.4	107.4	105	2.4	14	4
	3	●		MPS1-1300S-DIN-C	40.9	60.4	61.4	107.4	105	2.4	14	2
	5	□		MPS1-1300L-DIN	57.9	77.4	78.4	124.4	122	2.4	14	4
	5	●		MPS1-1300L-DIN-C	57.9	77.4	78.4	124.4	122	2.4	14	2
	2	●		MPS1-1300-PC	28.0	53.0	55.0	104.0	102	2.0	14	2
	8	●		MPS1-1300-L8C	106.7	145.7	148.7	194.7	192	2.7	14	2
	10	□		MPS1-1300-L10C	132.4	171.4	174.4	220.4	218	2.4	14	2
	12	●		MPS1-1300-L12C	158.4	197.4	200.4	246.4	244	2.4	14	2
	15	●		MPS1-1300-L15C	197.4	236.4	239.4	285.4	283	2.4	14	2
	20	●		MPS1-1300-L20C	262.4	301.4	304.4	350.4	348	2.4	14	2
13.1	3	□		MPS1-1310S-DIN	40.7	60.4	61.4	107.4	105	2.4	14	4
	3	●		MPS1-1310S-DIN-C	40.7	60.4	61.4	107.4	105	2.4	14	2
	5	□		MPS1-1310L-DIN	57.7	77.4	78.4	124.4	122	2.4	14	4
	5	●		MPS1-1310L-DIN-C	57.7	77.4	78.4	124.4	122	2.4	14	2
	2	□		MPS1-1310-PC	28.3	56.1	59.1	109.1	107	2.1	14	2
	8	●		MPS1-1310-L8C	107.5	151.7	154.7	200.7	198	2.7	14	2
	10	□		MPS1-1310-L10C	133.4	178.4	181.4	227.4	225	2.4	14	2
	12	□		MPS1-1310-L12C	159.6	205.4	208.4	254.4	252	2.4	14	2
	15	□		MPS1-1310-L15C	198.9	245.4	248.4	294.4	292	2.4	14	2
	20	□		MPS1-1310-L20C	264.4	313.4	316.4	362.4	360	2.4	14	2
13.2	3	□		MPS1-1320S-DIN	40.6	60.4	61.4	107.4	105	2.4	14	4
	3	●		MPS1-1320S-DIN-C	40.6	60.4	61.4	107.4	105	2.4	14	2
	5	□		MPS1-1320L-DIN	57.6	77.4	78.4	124.4	122	2.4	14	4
	5	●		MPS1-1320L-DIN-C	57.6	77.4	78.4	124.4	122	2.4	14	2
	2	●		MPS1-1320-PC	28.5	56.1	59.1	109.1	107	2.1	14	2
	8	●		MPS1-1320-L8C	108.3	151.7	154.7	200.7	198	2.7	14	2
	10	□		MPS1-1320-L10C	134.4	178.4	181.4	227.4	225	2.4	14	2
	12	●		MPS1-1320-L12C	160.8	205.4	208.4	254.4	252	2.4	14	2
	15	□		MPS1-1320-L15C	200.4	245.4	248.4	294.4	292	2.4	14	2
	20	□		MPS1-1320-L20C	266.4	313.4	316.4	362.4	360	2.4	14	2
13.3	3	□		MPS1-1330S-DIN	40.5	60.4	61.4	107.4	105	2.4	14	4
	3	●		MPS1-1330S-DIN-C	40.5	60.4	61.4	107.4	105	2.4	14	2
	5	□		MPS1-1330L-DIN	57.5	77.4	78.4	124.4	122	2.4	14	4
	5	●		MPS1-1330L-DIN-C	57.5	77.4	78.4	124.4	122	2.4	14	2
	2	□		MPS1-1330-PC	28.7	56.1	59.1	109.1	107	2.1	14	2
	8	●		MPS1-1330-L8C	109.2	151.8	154.8	200.8	198	2.8	14	2
	10	□		MPS1-1330-L10C	135.4	178.4	181.4	227.4	225	2.4	14	2
	12	□		MPS1-1330-L12C	162.0	205.4	208.4	254.4	252	2.4	14	2
	15	□		MPS1-1330-L15C	201.9	245.4	248.4	294.4	292	2.4	14	2
	20	□		MPS1-1330-L20C	268.4	313.4	316.4	362.4	360	2.4	14	2

DC	Bohrtiefe (mm)	Bohrtiefe (L/D)	DP1021	Bestellnummer	Abmessungen (mm)							Typ
					LU	LCF	LH	OAL	LF	PL	DCONMS	
13.4	3	□		MPS1-1340S-DIN	40.3	60.4	61.4	107.4	105	2.4	14	4
	3	●		MPS1-1340S-DIN-C	40.3	60.4	61.4	107.4	105	2.4	14	2
	5	□		MPS1-1340L-DIN	57.3	77.4	78.4	124.4	122	2.4	14	4
	5	●		MPS1-1340L-DIN-C	57.3	77.4	78.4	124.4	122	2.4	14	2
	2	□		MPS1-1340-PC	28.9	56.1	59.1	109.1	107	2.1	14	2
	8	●		MPS1-1340-L8C	110.0	151.8	154.8	200.8	198	2.8	14	2
	10	□		MPS1-1340-L10C	136.4	178.4	181.4	227.4	225	2.4	14	2
	12	□		MPS1-1340-L12C	163.2	205.4	208.4	254.4	252	2.4	14	2
	15	□		MPS1-1340-L15C	203.4	245.4	248.4	294.4	292	2.4	14	2
	20	□		MPS1-1340-L20C	270.4	313.4	316.4	362.4	360	2.4	14	2
13.5	3	□		MPS1-1350S-DIN	40.2	60.5	61.5	107.5	105	2.5	14	4
	3	●		MPS1-1350S-DIN-C	40.2	60.5	61.5	107.5	105	2.5	14	2
	5	□		MPS1-1350L-DIN	57.2	77.5	78.5	124.5	122	2.5	14	4
	5	●		MPS1-1350L-DIN-C	57.2	77.5	78.5	124.5	122	2.5	14	2
	2	●		MPS1-1350-PC	29.1	56.1	59.1	109.1	107	2.1	14	2
	8	●		MPS1-1350-L8C	110.8	151.8	154.8	200.8	198	2.8	14	2
	10	□		MPS1-1350-L10C	137.5	178.5	181.5	227.5	225	2.5	14	2
	12	●		MPS1-1350-L12C	164.5	205.5	208.5	254.5	252	2.5	14	2
	15	□		MPS1-1350-L15C	205.0	245.5	248.5	294.5	292	2.5	14	2
	20	□		MPS1-1350-L20C	272.5	313.5	316.5	362.5	360	2.5	14	2
13.6	3	□		MPS1-1360S-DIN	40.1	60.5	61.5	107.5	105	2.5	14	4
	3	●		MPS1-1360S-DIN-C	40.1	60.5	61.5	107.5	105	2.5	14	2
	5	□		MPS1-1360L-DIN	57.1	77.5	78.5	124.5	122	2.5	14	4
	5	●		MPS1-1360L-DIN-C	57.1	77.5	78.5	124.5	122	2.5	14	2
	2	□		MPS1-1360-PC	29.3	56.1	56.1	109.1	107	2.1	14	2
	8	●		MPS1-1360-L8C	111.6	156.8	159.8	205.8	203	2.8	14	2
	10	□		MPS1-1360-L10C	138.5	184.5	187.5	233.5	231	2.5	14	2
	12	□		MPS1-1360-L12C	165.7	212.5	215.5	261.5	259	2.5	14	2
	15	□		MPS1-1360-L15C	206.5	254.5	257.5	303.5	301	2.5	14	2
	20	□		MPS1-1360-L20C	274.5	324.5	327.5	373.5	371	2.5	14	2
13.7	3	□		MPS1-1370S-DIN	39.9	60.5	61.5	107.5	105	2.5	14	4
	3	●		MPS1-1370S-DIN-C	39.9	60.5	61.5	107.5	105	2.5	14	2
	5	□		MPS1-1370L-DIN	56.9	77.5	78.5	124.5	122	2.5	14	4
	5	●		MPS1-1370L-DIN-C	56.9	77.5	78.5	124.5	122	2.5	14	2
	2	□		MPS1-1370-PC	29.6	56.2	56.2	109.2	107	2.2	14	2
	8	●		MPS1-1370-L8C	112.4	156.8	159.8	205.8	203	2.8	14	2
	10	□		MPS1-1370-L10C	139.5	184.5	187.5	233.5	231	2.5	14	2
	12	□		MPS1-1370-L12C	166.9	212.5	215.5	261.5	259	2.5	14	2
	15	□		MPS1-1370-L15C	208.0	254.5	257.5	303.5	301	2.5	14	2
	20	□		MPS1-1370-L20C	276.5	324.5	327.5	373.5	371	2.5	14	2
13.8	3	□		MPS1-1380S-DIN	39.8	60.5	61.5	107.5	105	2.5	14	4
	3	●		MPS1-1380S-DIN-C	39.8	60.5	61.5	107.5	105	2.5	14	2
	5	□		MPS1-1380L-DIN	56.8	77.5	78.5	124.5	122	2.5	14	4
	5	●		MPS1-1380L-DIN-C	56.8	77.5	78.5	124.5	122	2.5	14	2
	2	□		MPS1-1380-PC	29.8	56.2	56.2	109.2	107	2.2	14	2
	8	●		MPS1-1380-L8C	113.3	156.9	159.9	205.9	203	2.9	14	2
	10	□		MPS1-1380-L10C	140.5	184.5	187.5	233.5	231	2.5	14	2
	12	□		MPS1-1380-L12C	168.1	212.5	215.5	261.5	259	2.5	14	2
	15	□		MPS1-1380-L15C	209.5	254.5	257.5	303.5	301	2.5	14	2
	20	□		MPS1-1380-L20C	278.5	324.5	327.5	373.5	371	2.5	14	2

● : Lagerstandard. □ : Herstellung nur auf Anfrage.

DC (mm)	Bohrtiefe (L/D)	DP1021	Bestellnummer	Abmessungen (mm)							Typ
				LU	LCF	LH	OAL	LF	PL	DCONMS	
13.9	3	□	MPS1-1390S-DIN	39.7	60.5	61.5	107.5	105	2.5	14	4
	3	●	MPS1-1390S-DIN-C	39.7	60.5	61.5	107.5	105	2.5	14	2
	5	□	MPS1-1390L-DIN	56.7	77.5	78.5	124.5	122	2.5	14	4
	5	●	MPS1-1390L-DIN-C	56.7	77.5	78.5	124.5	122	2.5	14	2
	2	□	MPS1-1390-PC	30.0	56.2	56.2	109.2	107	2.2	14	2
	8	●	MPS1-1390-L8C	114.1	156.9	159.9	205.9	203	2.9	14	2
	10	□	MPS1-1390-L10C	141.5	184.5	187.5	233.5	231	2.5	14	2
	12	□	MPS1-1390-L12C	169.3	212.5	215.5	261.5	259	2.5	14	2
	15	□	MPS1-1390-L15C	211.0	254.5	257.5	303.5	301	2.5	14	2
	20	□	MPS1-1390-L20C	280.5	324.5	327.5	373.5	371	2.5	14	2
14.0	3	□	MPS1-1400S-DIN	39.5	60.5	61.5	107.5	105	2.5	14	4
	3	●	MPS1-1400S-DIN-C	39.5	60.5	61.5	107.5	105	2.5	14	2
	5	□	MPS1-1400L-DIN	56.5	77.5	78.5	124.5	122	2.5	14	4
	5	●	MPS1-1400L-DIN-C	56.5	77.5	78.5	124.5	122	2.5	14	2
	2	●	MPS1-1400-PC	30.2	56.2	56.2	109.2	107	2.2	14	2
	8	●	MPS1-1400-L8C	114.9	156.9	159.9	205.9	203	2.9	14	2
	10	□	MPS1-1400-L10C	142.5	184.5	187.5	233.5	231	2.5	14	2
	12	●	MPS1-1400-L12C	170.5	212.5	215.5	261.5	259	2.5	14	2
	15	□	MPS1-1400-L15C	212.5	254.5	257.5	303.5	301	2.5	14	2
	20	●	MPS1-1400-L20C	282.5	324.5	327.5	373.5	371	2.5	14	2
14.2	3	□	MPS1-1420S-DIN	43.3	64.6	65.6	114.6	112	2.6	16	4
	3	●	MPS1-1420S-DIN-C	43.3	64.6	65.6	114.6	112	2.6	16	2
	5	□	MPS1-1420L-DIN	61.3	82.6	83.6	132.6	130	2.6	16	4
	5	●	MPS1-1420L-DIN-C	61.3	82.6	83.6	132.6	130	2.6	16	2
14.5	3	□	MPS1-1450S-DIN	42.9	64.6	65.6	114.6	112	2.6	16	4
	3	●	MPS1-1450S-DIN-C	42.9	64.6	65.6	114.6	112	2.6	16	2
	5	□	MPS1-1450L-DIN	60.9	82.6	83.6	132.6	130	2.6	16	4
	5	●	MPS1-1450L-DIN-C	60.9	82.6	83.6	132.6	130	2.6	16	2
15.0	3	□	MPS1-1500S-DIN	42.2	64.7	65.7	114.7	112	2.7	16	4
	3	●	MPS1-1500S-DIN-C	42.2	64.7	65.7	114.7	112	2.7	16	2
	5	□	MPS1-1500L-DIN	60.2	82.7	83.7	132.7	130	2.7	16	4
	5	●	MPS1-1500L-DIN-C	60.2	82.7	83.7	132.7	130	2.7	16	2
15.5	3	□	MPS1-1550S-DIN	41.6	64.8	65.8	114.8	112	2.8	16	4
	3	●	MPS1-1550S-DIN-C	41.6	64.8	65.8	114.8	112	2.8	16	2
	5	□	MPS1-1550L-DIN	59.6	82.8	83.8	132.8	130	2.8	16	4
	5	●	MPS1-1550L-DIN-C	59.6	82.8	83.8	132.8	130	2.8	16	2
16.0	3	□	MPS1-1600S-DIN	40.9	64.9	65.9	114.9	112	2.9	16	4
	3	●	MPS1-1600S-DIN-C	40.9	64.9	65.9	114.9	112	2.9	16	2
	5	□	MPS1-1600L-DIN	58.9	82.9	83.9	132.9	130	2.9	16	4
	5	●	MPS1-1600L-DIN-C	58.9	82.9	83.9	132.9	130	2.9	16	2
16.5	3	□	MPS1-1650S-DIN	48.3	73.0	74.0	123.0	120	3.0	18	4
	3	●	MPS1-1650S-DIN-C	48.3	73.0	74.0	123.0	120	3.0	18	2
	5	□	MPS1-1650L-DIN	68.3	93.0	94.0	143.0	140	3.0	18	4
	5	●	MPS1-1650L-DIN-C	68.3	93.0	94.0	143.0	140	3.0	18	2
17.0	3	□	MPS1-1700S-DIN	47.6	73.1	74.1	123.1	120	3.1	18	4
	3	●	MPS1-1700S-DIN-C	47.6	73.1	74.1	123.1	120	3.1	18	2
	5	□	MPS1-1700L-DIN	67.6	93.1	94.1	143.1	140	3.1	18	4
	5	●	MPS1-1700L-DIN-C	67.6	93.1	94.1	143.1	140	3.1	18	2
17.5	3	□	MPS1-1750S-DIN	46.9	73.2	74.2	123.2	120	3.2	18	4
	3	●	MPS1-1750S-DIN-C	46.9	73.2	74.2	123.2	120	3.2	18	2
	5	□	MPS1-1750L-DIN	66.9	93.2	94.2	143.2	140	3.2	18	4
	5	●	MPS1-1750L-DIN-C	66.9	93.2	94.2	143.2	140	3.2	18	2
18.0	3	□	MPS1-1800S-DIN	46.3	73.3	74.3	123.3	120	3.3	18	4
	3	●	MPS1-1800S-DIN-C	46.3	73.3	74.3	123.3	120	3.3	18	2
	5	□	MPS1-1800L-DIN	66.3	93.3	94.3	143.3	140	3.3	18	4
	5	●	MPS1-1800L-DIN-C	66.3	93.3	94.3	143.3	140	3.3	18	2

DC (mm)	Bohrtiefe (L/D)	DP1021	Bestellnummer	Abmessungen (mm)							Typ
				LU	LCF	LH	OAL	LF	PL	DCONMS	
18.5	3	□	MPS1-1850S-DIN	51.6	79.4	80.4	131.4	128	3.4	20	4
	3	●	MPS1-1850S-DIN-C	51.6	79.4	80.4	131.4	128	3.4	20	2
	5	□	MPS1-1850L-DIN	73.6	101.4	102.4	153.4	150	3.4	20	4
	5	●	MPS1-1850L-DIN-C	73.6	101.4	102.4	153.4	150	3.4	20	2
19.0	3	□	MPS1-1900S-DIN	51.0	79.5	80.5	131.5	128	3.5	20	4
	3	●	MPS1-1900S-DIN-C	51.0	79.5	80.5	131.5	128	3.5	20	2
	5	□	MPS1-1900L-DIN	73.0	101.5	102.5	153.5	150	3.5	20	4
	5	●	MPS1-1900L-DIN-C	73.0	101.5	102.5	153.5	150	3.5	20	2
19.5	3	□	MPS1-1950S-DIN	50.3	79.5	80.5	131.5	128	3.5	20	4
	3	●	MPS1-1950S-DIN-C	50.3	79.5	80.5	131.5	128	3.5	20	2
	5	□	MPS1-1950L-DIN	72.3	101.5	102.5	153.5	150	3.5	20	4
5	●	MPS1-1950L-DIN-C	72.3	101.5	102.5	153.5	150	3.5	20	2	
20.0	3	□	MPS1-2000S-DIN	49.6	79.6	80.6	131.6	128	3.6	20	4
	3	●	MPS1-2000S-DIN-C	49.6	79.6	80.6	131.6	128	3.6	20	2
	5	□	MPS1-2000L-DIN	71.6	101.6	102.6	153.6	150	3.6	20	4
	5	●	MPS1-2000L-DIN-C	71.6	101.6	102.6	153.6	150	3.6	20	2

# BOHREN (VOLLHARTMETALL)

## MPS1

4-Fasen & Super Long-VHM-Bohrer

### SCHNITTDATENEMPFEHLUNGEN

#### ● MPS1 (3xDC – 40xDC)

DC	L x DC		P			M	K		
			Allg. Baustahl, C-Stahl, Leg. Stahl			Rostfreier Stahl	Guss		
			≤ 180 HB	180–250 HB	280–350 HB		≤ 350 MPa	≤ 450 MPa	≤ 800 MPa
3	3–8	Vc m/min	100 (60–150)	90 (60–140)	80 (50–110)	40 (20–50)	90 (60–100)	80 (50–90)	60 (40–80)
		f mm/U.	0.15 (0.1–0.2)	0.15 (0.1–0.19)	0.12 (0.1–0.14)	0.08 (0.06–0.12)	0.15 (0.1–0.2)	0.12 (0.08–0.16)	0.09 (0.06–0.12)
	10–25	Vc m/min	90 (40–110)	90 (40–110)	80 (40–90)	40 (20–60)	90 (40–110)	90 (40–110)	—
		f mm/U.	0.17 (0.1–0.24)	0.17 (0.1–0.24)	0.15 (0.09–0.22)	0.07 (0.05–0.09)	0.19 (0.11–0.26)	0.17 (0.1–0.24)	—
	30–40	Vc m/min	75 (40–95)	75 (40–85)	65 (40–75)	30 (20–50)	75 (45–95)	30 (20–50)	—
		f mm/U.	0.14 (0.08–0.19)	0.14 (0.08–0.19)	0.15 (0.07–0.18)	0.06 (0.04–0.07)	0.15 (0.09–0.21)	0.14 (0.08–0.19)	—
4	3–8	Vc m/min	120 (70–170)	100 (70–160)	90 (60–120)	40 (30–50)	100 (70–110)	90 (60–100)	70 (50–90)
		f mm/U.	0.19 (0.12–0.25)	0.18 (0.12–0.24)	0.15 (0.12–0.18)	0.09 (0.07–0.13)	0.21 (0.12–0.3)	0.17 (0.1–0.24)	0.13 (0.08–0.18)
	10–25	Vc m/min	90 (40–110)	90 (40–110)	80 (40–90)	40 (20–60)	90 (40–110)	90 (40–110)	—
		f mm/U.	0.2 (0.12–0.3)	0.2 (0.12–0.3)	0.18 (0.11–0.27)	0.08 (0.06–0.1)	0.22(0.13–0.33)	0.2 (0.12–0.3)	—
	30–40	Vc m/min	75 (40–95)	75 (40–85)	65 (40–75)	30 (20–50)	75 (45–95)	30 (20–50)	—
		f mm/U.	0.16 (0.1–0.24)	0.16 (0.1–0.24)	0.18 (0.09–0.22)	0.06 (0.05–0.08)	0.18 (0.1–0.26)	0.16 (0.1–0.24)	—
5	3–8	Vc m/min	130 (80–190)	110 (80–180)	90 (70–140)	40 (30–50)	110 (80–130)	90 (70–120)	70 (60–100)
		f mm/U.	0.23 (0.15–0.3)	0.22 (0.15–0.29)	0.19 (0.15–0.22)	0.11 (0.08–0.16)	0.25 (0.15–0.35)	0.21 (0.14–0.28)	0.17 (0.12–0.22)
	10–25	Vc m/min	90 (40–110)	90 (40–110)	80 (40–90)	40 (20–60)	90 (40–110)	90 (40–110)	—
		f mm/U.	0.25 (0.15–0.35)	0.25 (0.15–0.35)	0.22 (0.14–0.32)	0.1 (0.07–0.12)	0.28 (0.17–0.39)	0.25 (0.15–0.35)	—
	30–40	Vc m/min	75 (40–95)	75 (40–85)	65 (40–75)	30 (20–50)	75 (45–95)	30 (20–50)	—
		f mm/U.	0.2 (0.12–0.28)	0.2 (0.12–0.28)	0.22 (0.11–0.26)	0.08 (0.06–0.1)	0.22 (0.13–0.31)	0.2 (0.12–0.28)	—
6	3–8	Vc m/min	140 (90–210)	120 (90–190)	100 (80–150)	50 (40–70)	120 (90–140)	100 (80–130)	80 (70–110)
		f mm/U.	0.27 (0.18–0.35)	0.26 (0.18–0.33)	0.22 (0.18–0.25)	0.14 (0.11–0.18)	0.29 (0.18–0.4)	0.25 (0.16–0.34)	0.2 (0.14–0.26)
	10–25	Vc m/min	110 (70–120)	100 (60–110)	90 (40–110)	50 (20–60)	100 (60–110)	100 (60–110)	—
		f mm/U.	0.27 (0.17–0.37)	0.24 (0.15–0.33)	0.24 (0.15–0.33)	0.12 (0.08–0.16)	0.3 (0.19–0.41)	0.27 (0.17–0.37)	—
	30–40	Vc m/min	90 (40–110)	80 (40–90)	75 (40–85)	40 (20–60)	90 (60–110)	40 (30–60)	—
		f mm/U.	0.22 (0.14–0.3)	0.22 (0.14–0.3)	0.24 (0.12–0.26)	0.1 (0.06–0.13)	0.24 (0.15–0.33)	0.22 (0.14–0.3)	—
8	3–8	Vc m/min	160 (100–240)	140 (100–220)	120 (90–170)	50 (40–70)	140 (100–160)	120 (90–150)	100 (80–130)
		f mm/U.	0.3 (0.2–0.4)	0.29 (0.2–0.38)	0.24 (0.2–0.27)	0.15 (0.12–0.2)	0.33 (0.2–0.45)	0.28 (0.18–0.38)	0.23 (0.16–0.3)
	10–25	Vc m/min	110 (70–120)	100 (60–110)	90 (40–110)	50 (20–60)	100 (60–110)	100 (60–110)	—
		f mm/U.	0.3 (0.2–0.4)	0.3 (0.2–0.4)	0.27 (0.18–0.36)	0.14 (0.1–0.17)	0.33 (0.22–0.44)	0.3 (0.2–0.4)	—
	30–40	Vc m/min	90 (40–110)	80 (40–90)	75 (40–85)	40 (20–50)	90 (60–100)	40 (30–60)	—
		f mm/U.	0.24 (0.16–0.32)	0.24 (0.16–0.32)	0.27 (0.14–0.29)	0.11 (0.08–0.14)	0.26 (0.18–0.35)	0.24 (0.16–0.32)	—
10	3–8	Vc m/min	170 (100–250)	150 (100–230)	130 (90–180)	50 (40–70)	150 (100–170)	130 (90–160)	110 (80–140)
		f mm/U.	0.33 (0.2–0.45)	0.32 (0.2–0.43)	0.25 (0.2–0.3)	0.16 (0.12–0.22)	0.35 (0.2–0.5)	0.29 (0.18–0.4)	0.24 (0.16–0.32)
	10–25	Vc m/min	110 (70–120)	100 (60–110)	90 (40–110)	50 (20–60)	100 (60–110)	100 (60–110)	—
		f mm/U.	0.32 (0.22–0.42)	0.32 (0.22–0.42)	0.29 (0.2–0.38)	0.15 (0.12–0.18)	0.35 (0.24–0.46)	0.32 (0.22–0.42)	—
	30–40	Vc m/min	90 (40–110)	80 (40–90)	75 (40–95)	40 (20–50)	90 (60–100)	40 (30–60)	—
		f mm/U.	0.26 (0.18–0.34)	0.26 (0.18–0.34)	0.29 (0.16–0.3)	0.12 (0.1–0.14)	0.28 (0.19–0.37)	0.26 (0.18–0.34)	—
12	3–8	Vc m/min	180 (100–250)	160 (100–230)	140 (90–180)	50 (40–70)	160 (100–170)	140 (90–160)	110 (80–140)
		f mm/U.	0.35 (0.2–0.5)	0.34 (0.2–0.48)	0.27 (0.2–0.34)	0.18 (0.14–0.24)	0.4 (0.2–0.6)	0.31 (0.18–0.44)	0.25 (0.16–0.34)
	10–25	Vc m/min	130 (90–150)	120 (80–140)	100 (60–110)	60 (25–65)	120 (90–140)	120 (90–140)	—
		f mm/U.	0.34 (0.24–0.44)	0.34 (0.24–0.44)	0.3 (0.22–0.4)	0.17 (0.14–0.19)	0.37 (0.26–0.48)	0.34 (0.24–0.44)	—
	30–40	Vc m/min	105 (55–125)	95 (55–105)	80 (40–100)	50 (20–60)	105 (65–115)	50 (40–70)	—
		f mm/U.	0.27 (0.19–0.35)	0.27 (0.19–0.35)	0.3 (0.18–0.32)	0.14 (0.11–0.15)	0.3 (0.21–0.38)	0.27 (0.19–0.35)	—
16	3–8	Vc m/min	180 (100–250)	160 (100–230)	140 (90–180)	50 (40–70)	160 (100–170)	140 (90–160)	110 (80–140)
		f mm/U.	0.38 (0.2–0.55)	0.36 (0.2–0.52)	0.28 (0.2–0.36)	0.19 (0.15–0.26)	0.43 (0.2–0.65)	0.33 (0.18–0.48)	0.27 (0.16–0.38)
	10–25	Vc m/min	130 (90–150)	120 (80–140)	100 (60–110)	60 (25–65)	120 (90–140)	120 (90–140)	—
		f mm/U.	0.36 (0.26–0.46)	0.36 (0.26–0.46)	0.32 (0.23–0.41)	0.17 (0.14–0.19)	0.4 (0.29–0.48)	0.36 (0.26–0.46)	—
20	3–8	Vc m/min	180 (100–250)	160 (100–230)	140 (90–180)	50 (40–70)	160 (100–170)	140 (90–160)	110 (80–140)
		f mm/U.	0.4 (0.2–0.6)	0.39 (0.2–0.57)	0.3 (0.2–0.4)	0.21 (0.16–0.28)	0.45 (0.2–0.7)	0.35 (0.18–0.52)	0.28 (0.16–0.4)

## ■ BEDIENHINWEISE FÜR MPS1-TIEFLOCHBOHRER

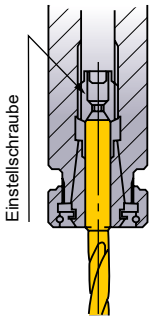
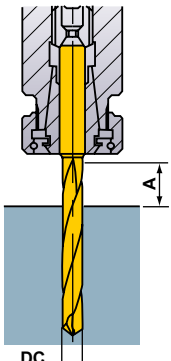
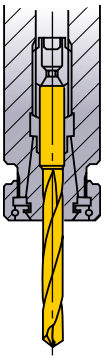
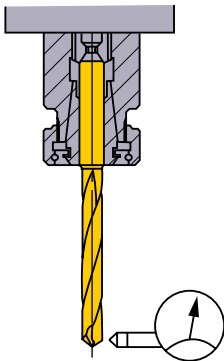
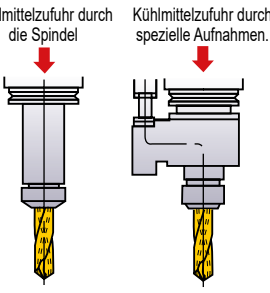
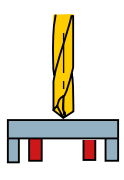
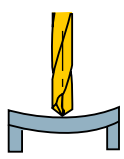
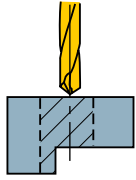
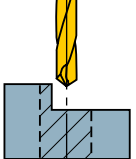
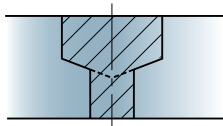
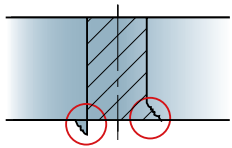
<p><b>Bohreraufnahme</b></p>  <p>Präzisionsspannzangen können verwendet werden.</p>	<p><b>Max. Bohrtiefe</b></p>  <p><math>A \geq DC \times 1.5</math></p>	<p><b>Bohrer-Einstellung</b></p>  <p>Nicht auf den Nuten spannen.</p>	<p><b>Rundlauftoleranz</b></p>  <p>Rundlaufabweichung <math>\leq 0.03\text{mm}</math></p>
<p><b>Interne Kühlmittelzufuhr</b></p>  <p>Kühlmittelzufuhr durch die Spindel      Kühlmittelzufuhr durch spezielle Aufnahmen.</p> <p>Kühlmitteldruck liegt bei etwa: 5–10 bar (<math>&lt; \varnothing 5:2-30</math> bar).</p>	<p><b>Handling mit Kühlmittel</b></p> <ol style="list-style-type: none"> <li>1) Kleine Partikel können die Kühlmittelbohrungen verstopfen. Verwenden Sie daher bitte einen Kühlmittelfilter.</li> <li>2) Stark verschmutztes Kühlmittel reduziert den Spänefluss. Wir empfehlen ein regelmäßiges Wechseln des Kühlmittels. Bitte prüfen Sie eine einwandfreie Kühlmittelzufuhr!</li> </ol>	<p><b>Dünne Werkstücke</b></p>  <p><b>OK</b> Stützen Sie das Werkstück.</p>  <p><b>X</b> Wenn Werkstücke verbiegen...</p>	<p><b>Unterbrochene Bearbeitung</b></p>  <p>Ohne Vorbearbeitung <b>OK</b> ① Reduzieren Sie den Vorschub an der unterbrochenen Stelle.</p>  <p>Benötigt Vorbearbeitung ① Planen Sie die Fläche mit einem Fräser vorab.</p>
<p><b>Stufenbohrungen</b></p>  <ol style="list-style-type: none"> <li>① Geteilt in 2 Prozesse.</li> <li>② Bohren Sie das größere Loch zuerst.</li> </ol> <p>*Auf Anfrage bieten wir auch Stufenbohrer an, die Stufenbohrungen in einem Prozess herstellen können.</p>	<p><b>Gratbildung oder Ausbrüche am Werkstück</b></p>  <ol style="list-style-type: none"> <li>① Reduzieren Sie den Vorschub um ca. 50% beim Austritt.</li> <li>② Schleifen Sie eine 45° Fasse an den Bohrer.</li> <li>③ Tauschen Sie den Bohrer durch einen anderen mit größerem Spitzenwinkel.</li> </ol>		

## BENUTZERHINWEISE FÜR MPS1-TIEFLOCHBOHRER (L/D≥10)

### BOHREN AUF EINER EBENEN FLÄCHE

#### 1. Pilotbohrung setzen

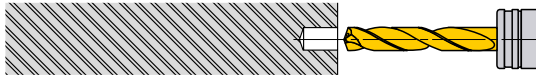

- ① Verwenden Sie den kürzestmöglichen MPS1-Bohrer (PC).
- ② Die Pilotbohrung muss ca. 1DC oder tiefer sein (auf Präzision achten).

#### 2. Einfahren in die Pilotbohrung

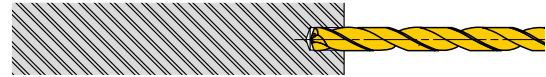

- ① Mit niedriger Drehzahl in die Pilotbohrung einfahren. (Drehzahl 500 min<sup>-1</sup>, Vorschub 0.2 – 0.3mm/U)
- ② Tieflochbohrer 0.5–1mm vor dem Boden der Pilotbohrung stoppen.

#### 3. Tieflochbohren

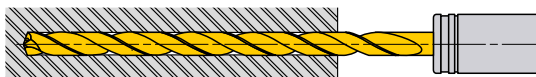

- ① Mit der empfohlenen Drehzahl und Vorschubrate in einem gleichmäßigen Zyklus (kontinuierlicher Vorschub) bis zur gewünschten Bohrungstiefe bohren (ohne zu lüften).

#### 4. Herausfahren des Tieflochbohrers

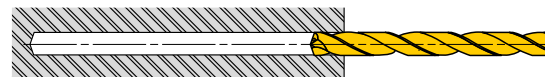

- ① Reduzieren Sie nach Erreichen der Bohrtiefe die Drehzahl. (Drehzahl 500min<sup>-1</sup>)
- ② Bohrer bis zur Tiefe der Pilotbohrung (1DC) bei einem Vorschub von 3000mm/min zurückfahren.
- ③ Fahren Sie den Bohrer anschließend mit einem Vorschub von 0.2–0.3mm/U ganz heraus.

### BOHREN AUF UNEBENEN FLÄCHEN

#### 1. Anspiegeln

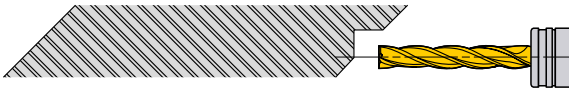

- ① Bearbeiten Sie die unebene Fläche mit einem geeigneten Schaffräser oder Flachbohrer, der zum Anspiegeln geeignet ist. Der Durchmesser der Planfläche muss mindestens so groß wie der Durchmesser des Tieflochbohrers sein (auf Durchmessertoleranzen achten).

#### 2. Pilotbohrung setzen



- ① Verwenden Sie den kürzestmöglichen MPS1-Bohrer (PC).
- ② Die Pilotbohrung muss ca. 1DC oder tiefer sein (auf Präzision achten).

#### 3. Einfahren in die Pilotbohrung



- ① Mit niedriger Drehzahl in die Pilotbohrung einfahren. (Drehzahl 500 min<sup>-1</sup>, Vorschub 0.2 – 0.3mm/U)
- ② Tieflochbohrer 0.5–1mm vor dem Boden der Pilotbohrung stoppen.

#### 4. Tieflochbohren

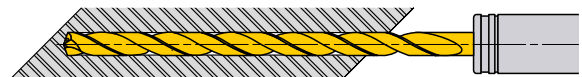

- ① Mit der empfohlenen Drehzahl und Vorschubrate in einem gleichmäßigen Zyklus (kontinuierlicher Vorschub) bis zur gewünschten Bohrungstiefe bohren (ohne zu lüften).

#### 5. Durchbohren

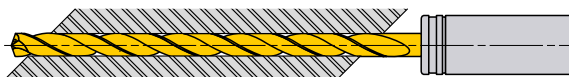

- ① Reduzieren Sie den Vorschub beim Austritt aus der Bohrung, um Beschädigungen an der Schneidkante zu vermeiden.

#### 6. Herausfahren des Bohrers



- ① Reduzieren Sie nach Erreichen der Bohrtiefe die Drehzahl. (Drehzahl 500min<sup>-1</sup>)
- ② Bohrer bis zur Tiefe der Pilotbohrung (1DC) bei einem Vorschub von 3000mm/min zurückfahren.
- ③ Fahren Sie den Bohrer anschließend mit einem Vorschub von 0.2–0.3mm/U ganz heraus.



# MICRO-MGS

- VHM-Einlippenbohrer mit interner Kühlmittelzufuhr.
- Hervorragende Rundlaufgenauigkeit gewährleistet hochpräzises Bohren.



HARTMETALL



Interne Kühlung

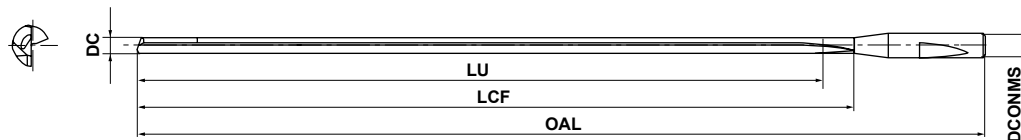

	DC ≤ 3
	0
	-0.005

● MGS Bohrer eignen sich für die Verwendung mit Schrumpfaufnahmen.

DC (mm)	Bohrtiefe (L/D)	HT110	Bestellnummer	Abmessungen (mm)			
				LU	LCF	OAL	DCONMS
0.7	50	★	MGS0070L040B	35.0	40	80	3
	80	★	MGS0070L060B	56.0	60	100	3
0.8	45	★	MGS0080L040B	36.0	40	80	3
	70	★	MGS0080L060B	56.0	60	100	3
0.9	40	★	MGS0090L040B	36.0	40	80	3
	60	★	MGS0090L060B	54.0	60	100	3
1.0	35	★	MGS0100L040B	35.0	40	80	3
	55	★	MGS0100L060B	55.0	60	100	3
	75	★	MGS0100L080B	75.0	80	120	3
1.1	30	★	MGS0110L040B	33.0	40	80	3
	50	★	MGS0110L060B	55.0	60	100	3
	65	★	MGS0110L080B	71.5	80	120	3
1.2	30	★	MGS0120L040B	36.0	40	80	3
	45	★	MGS0120L060B	54.0	60	100	3
	60	★	MGS0120L080B	72.0	80	120	3
1.3	40	★	MGS0130L060B	52.0	60	100	3
	55	★	MGS0130L080B	71.5	80	120	3
	70	★	MGS0130L100B	91.0	100	140	3
1.4	35	★	MGS0140L060B	49.0	60	100	3
	50	★	MGS0140L080B	70.0	80	120	3
	65	★	MGS0140L100B	91.0	100	140	3
1.5	35	★	MGS0150L060B	52.5	60	100	3
	50	★	MGS0150L080B	75.0	80	120	3
	60	★	MGS0150L100B	90.0	100	140	3
1.6	30	★	MGS0160L060B	48.0	60	100	3
	45	★	MGS0160L080B	72.0	80	120	3
	55	★	MGS0160L100B	88.0	100	140	3
1.7	30	★	MGS0170L060B	51.0	60	100	3
	40	★	MGS0170L080B	68.0	80	120	3
	55	★	MGS0170L100B	93.5	100	140	3

DC (mm)	Bohrtiefe (L/D)	HT110	Bestellnummer	Abmessungen (mm)			
				LU	LCF	OAL	DCONMS
1.8	30	★	MGS0180L060B	54.0	60	100	3
	40	★	MGS0180L080B	72.0	80	120	3
	50	★	MGS0180L100B	90.0	100	140	3
1.9	25	★	MGS0190L060B	47.5	60	100	3
	35	★	MGS0190L080B	66.5	80	120	3
	45	★	MGS0190L100B	85.5	100	140	3
2.0	25	★	MGS0200L060B	50.0	60	100	3
	35	★	MGS0200L080B	70.0	80	120	3
	45	★	MGS0200L100B	90.0	100	140	3
2.1	35	★	MGS0210L080B	73.5	80	120	3
	40	★	MGS0210L100B	84.0	100	140	3
2.2	30	★	MGS0220L080B	66.0	80	120	3
	40	★	MGS0220L100B	88.0	100	140	3
2.3	30	★	MGS0230L080B	69.0	80	120	3
	40	★	MGS0230L100B	92.0	100	140	3
2.4	30	★	MGS0240L080B	72.0	80	120	3
	35	★	MGS0240L100B	84.0	100	140	3
2.5	25	★	MGS0250L080B	62.5	80	120	3
	35	★	MGS0250L100B	87.5	100	140	3
2.6	25	★	MGS0260L080B	65.0	80	120	3
	35	★	MGS0260L100B	91.0	100	140	3
2.7	25	★	MGS0270L080B	67.5	80	120	3
	30	★	MGS0270L100B	81.0	100	140	3
2.8	25	★	MGS0280L080B	70.0	80	120	3
	30	★	MGS0280L100B	84.0	100	140	3
2.9	20	★	MGS0290L080B	58.0	80	120	3
	30	★	MGS0290L100B	87.0	100	140	3
3.0	20	★	MGS0300L080B	60.0	80	120	3
	30	★	MGS0300L100B	90.0	100	140	3

Hinweis 1) Bitte setzen Sie sich mit uns in Verbindung, um Informationen zu beschichteten Bohrern zu erhalten.  
(VP, GP und UP besch. Hartmetall).

★ : Lagerstandard in Japan.

SCHNITTBEDINGUNGEN > M076  
TECHNISCHE DATEN > P001

M075

M

BOHREN

## MICRO-MGS

### BOHRBUCHSE

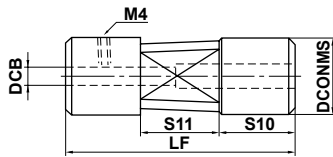

### BEI VERWENDUNG EINER BOHRBUCHSE

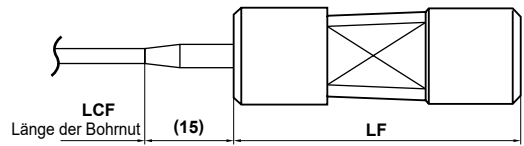

Bestellnummer	Lager	Abmessungen (mm)					Schraube	Schlüssel
		DCONMS	DCB	LF	S10	S11		
<b>MGD38</b>	★	12.7	3.0	38.1	12.6	12.7	HSS04004	HKY20F
<b>MGD70</b>	★	12.7	3.0	70.0	25.0	20.0	HSS04004	HKY20F

### SCHNITTDATENEMPFEHLUNGEN

Material	P				P				
	Allg. Baustahl (≤180HB)				C-Stahl Leg. Stahl (180–280HB)				
Kühlmittel	Nicht wasserlösliche Emulsion				Nicht wasserlösliche Emulsion				
	Bohrer-Durchm. DC (mm)	Schnittgeschw. (m/min)	Drehzahl (min <sup>-1</sup> )	Vorschub (min.–max.) (mm/U.)	Tischvorschub (mm/min)	Schnittgeschw. (m/min)	Drehzahl (min <sup>-1</sup> )	Vorschub (min.–max.) (mm/U.)	Tischvorschub (mm/min)
Ck10									

Material	P				M				
	C-Stahl Leg. Stahl (280–350HB)				Rostfreier Stahl (austenitisch) (≤200HB)				
Kühlmittel	Nicht wasserlösliche Emulsion				Nicht wasserlösliche Emulsion				
	Bohrer-Durchm. DC (mm)	Schnittgeschw. (m/min)	Drehzahl (min <sup>-1</sup> )	Vorschub (min.–max.) (mm/U.)	Tischvorschub (mm/min)	Schnittgeschw. (m/min)	Drehzahl (min <sup>-1</sup> )	Vorschub (min.–max.) (mm/U.)	Tischvorschub (mm/min)
36CrNiMo4									

Material	K				K				
	Grauguss (≤350MPa)				Duktiler Guss (≤450MPa)				
Kühlmittel	Nicht wasserlösliche Emulsion • Wasserlösliche Emulsion				Nicht wasserlösliche Emulsion • Wasserlösliche Emulsion				
	Bohrer-Durchm. DC (mm)	Schnittgeschw. (m/min)	Drehzahl (min <sup>-1</sup> )	Vorschub (min.–max.) (mm/U.)	Tischvorschub (mm/min)	Schnittgeschw. (m/min)	Drehzahl (min <sup>-1</sup> )	Vorschub (min.–max.) (mm/U.)	Tischvorschub (mm/min)
GG30									

Hinweis 1) Zur Verbesserung der Prozesssicherheit und Produktivität wird der Einsatz eines Kühlmittels empfohlen. (Mindestkühlmitteldruck = 1000 PSI)

Hinweis 2) Der Kühlmittelfilter muss feiner als 5 Mikrometer sein.

Eine Feinfiltration ist notwendig, um die Blockierung der Kühlmittleitungen zu vermeiden.

Hinweis 3) Eine Pilotbohrung oder Bohrbuchse ist erforderlich.

★ : Lagerstandard in Japan.

## SCHNITTDATENEMPFEHLUNGEN

Material	N							
	Aluminiumleg. (Si<5%)				Kupfer, Kupfer Leg.			
Kühlmittel	Nicht wasserlösliche Emulsion • Wasserlösliche Emulsion				Nicht wasserlösliche Emulsion • Wasserlösliche Emulsion			
Bohrer Durchm. DC (mm)	Schnittgeschw. (m/min)	Drehzahl (min <sup>-1</sup> )	Vorschub (min. – max.) (mm/U.)	Tischvorschub (mm/min)	Schnittgeschw. (m/min)	Drehzahl (min <sup>-1</sup> )	Vorschub (min. – max.) (mm/U.)	Tischvorschub (mm/min)
<b>0.8</b>	50	19800	0.01 (0.008–0.016)	195	40	15900	0.01 (0.008–0.016)	155
<b>1.0</b>	60	19000	0.015 (0.010–0.020)	285	50	15900	0.015 (0.010–0.020)	235
<b>1.2</b>	70	18500	0.015 (0.012–0.024)	275	60	15900	0.015 (0.012–0.024)	235
<b>1.6</b>	80	15900	0.02 (0.016–0.032)	315	70	13900	0.02 (0.016–0.032)	275
<b>2.0</b>	90	14300	0.03 (0.020–0.040)	425	80	12700	0.03 (0.020–0.040)	380
<b>2.5</b>	100	12700	0.035 (0.025–0.050)	440	90	11400	0.035 (0.025–0.050)	395
<b>3.0</b>	100	10600	0.045 (0.030–0.060)	475	100	10600	0.045 (0.030–0.060)	475

Hinweis 1) Zur Verbesserung der Prozesssicherheit und Produktivität wird der Einsatz eines Kühlmittels empfohlen. (Mindestkühlmittelruck = 70 bar)

Hinweis 2) Der Kühlmittelfilter muss feiner als 5 Mikrometer sein.

Eine Feinfiltration ist notwendig, um die Blockierung der Kühlmittleitungen zu vermeiden.

Hinweis 3) Eine Pilotbohrung oder Führungsbuchse ist erforderlich.

## ANWENDUNGSANLEITUNG

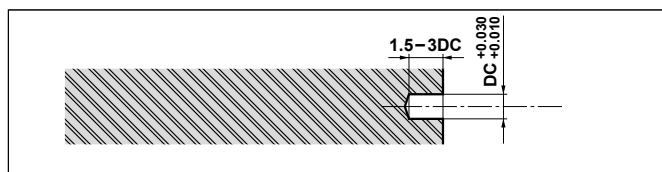

1. Pilotbohren  
(Mitsubishi Materials MVS oder MWS wird empfohlen.)

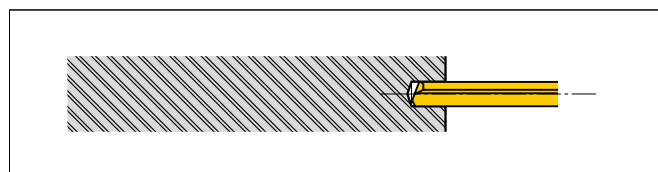

2. Eintritt in die Pilotbohrung im Stillstand oder mit gegenläufiger Drehzahl von < 300 U/Min.

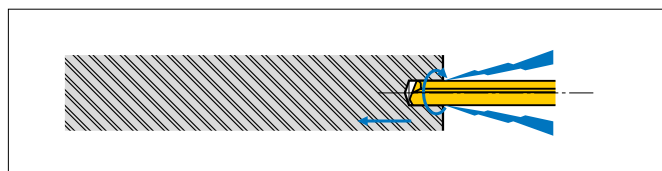

3. Kühlmittelzufuhr einschalten, Schnittgeschwindigkeit und Vorschub auf die empfohlenen Schnittdaten einstellen und mit dem Bohren beginnen.

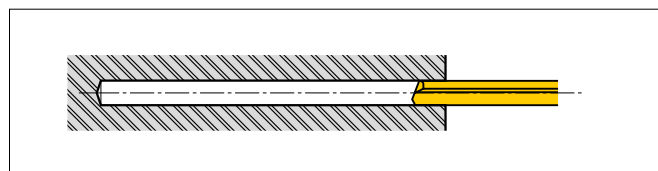

4. Nach dem Bohren die Maschine auf Position 2 zurücksetzen, Kühlmittelzufuhr stoppen und Drehzahl ausschalten.

# BOHREN (VOLLHARTMETALL)

# MMS

- Für das hochpräzise und effiziente Bohren von rostfreien Stahlarten.
- Trigon-Kühlkanalbohrungen beginnen ab einem Durchmesser von 4.60 mm.



P M K N S H

Interne Kühlung



	DC=3	3<DC≤6	6<DC≤10	10<DC≤18	18<DC≤20
DIN-Typ (m7)	+0.012 +0.002	+0.016 +0.004	+0.021 +0.006	+0.025 +0.007	+0.029 +0.008
Andere (h8)	0 -0.014	0 -0.018	-0.022 -0.022	0 -0.027	0 -0.033
		0 -0.008	0 -0.009	0 -0.011	0 -0.013

BOHREN

M

## ● Typ 1 Zylind. Schaft

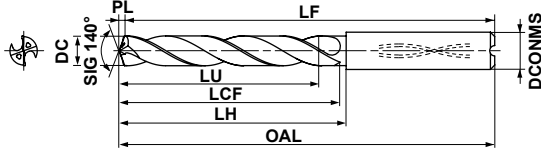

MMS----S/L-DIN-C (L/D 3-5)  
MMS----X3/X5DB (L/D 3-5)

## ● Typ 2 Schaft mit Whistle Notch

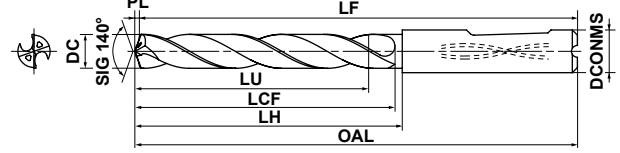

MMS----S/L-DIN (L/D 3-5)

## ● Typ 3 Zylind. Schaft mit konischem Hinterschliff

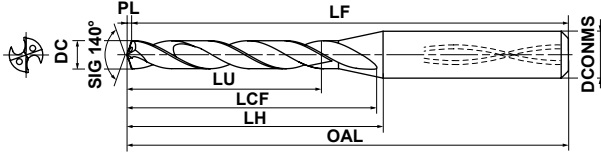

MMS----S/L-DIN-C (L/D 3-5)  
MMS----X3/X5DB (L/D 3-5)

## ● Typ 4 Schaft mit Whistle Notch und konischem Hinterschliff

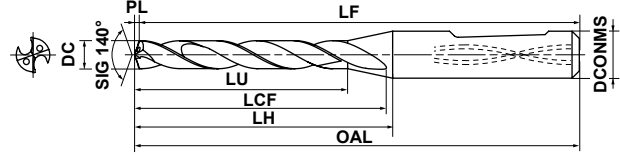

MMS----S/L-DIN (L/D 3-5)

DC (mm)	Bohrtiefe (L/D)	DP7020	Bestellnummer	Abmessungen (mm)						Typ	
				LU	LCF	LH	OAL	LF	PL		DCOMMS
3.0	3	□	MMS0300S-DIN	15.0	19.5	24.5	61.5	61	0.5	6	4
	3	●	MMS0300S-DIN-C	15.0	19.5	24.5	61.5	61	0.5	6	3
	5	□	MMS0300L-DIN	23.0	27.5	28.5	65.5	65	0.5	6	4
	5	●	MMS0300L-DIN-C	23.0	27.5	28.5	65.5	65	0.5	6	3
	3	★	MMS0300X3DB	9.5	21.5	23.5	70.5	70	0.5	6	3
	5	★	MMS0300X5DB	15.5	28.5	31.5	78.5	78	0.5	6	3
3.05	3	□	MMS0305S-DIN	15.0	19.6	24.6	61.6	61	0.6	6	4
	3	●	MMS0305S-DIN-C	15.0	19.6	24.6	61.6	61	0.6	6	3
	5	□	MMS0305L-DIN	23.0	27.6	28.6	65.6	65	0.6	6	4
	5	●	MMS0305L-DIN-C	23.0	27.6	28.6	65.6	65	0.6	6	3
3.1	3	□	MMS0310S-DIN	14.9	19.6	24.6	61.6	61	0.6	6	4
	3	●	MMS0310S-DIN-C	14.9	19.6	24.6	61.6	61	0.6	6	3
	5	□	MMS0310L-DIN	22.9	27.6	28.6	65.6	65	0.6	6	4
	5	●	MMS0310L-DIN-C	22.9	27.6	28.6	65.6	65	0.6	6	3
	3	★	MMS0310X3DB	9.9	21.6	23.6	70.6	70	0.6	6	3
	5	★	MMS0310X5DB	16.1	28.6	31.6	78.6	78	0.6	6	3
3.2	3	□	MMS0320S-DIN	14.8	19.6	24.6	61.6	61	0.6	6	4
	3	●	MMS0320S-DIN-C	14.8	19.6	24.6	61.6	61	0.6	6	3
	5	□	MMS0320L-DIN	22.8	27.6	28.6	65.6	65	0.6	6	4
	5	●	MMS0320L-DIN-C	22.8	27.6	28.6	65.6	65	0.6	6	3
	3	★	MMS0320X3DB	10.2	21.6	23.6	70.6	70	0.6	6	3
	5	★	MMS0320X5DB	16.6	28.6	31.6	78.6	78	0.6	6	3
3.3	3	□	MMS0330S-DIN	14.7	19.6	24.6	61.6	61	0.6	6	4
	3	●	MMS0330S-DIN-C	14.7	19.6	24.6	61.6	61	0.6	6	3
	5	□	MMS0330L-DIN	22.7	27.6	28.6	65.6	65	0.6	6	4
	5	●	MMS0330L-DIN-C	22.7	27.6	28.6	65.6	65	0.6	6	3
	3	★	MMS0330X3DB	10.5	21.6	23.6	70.6	70	0.6	6	3
	5	★	MMS0330X5DB	17.1	28.6	31.6	78.6	78	0.6	6	3
3.4	3	□	MMS0340S-DIN	14.5	19.6	24.6	61.6	61	0.6	6	4
	3	●	MMS0340S-DIN-C	14.5	19.6	24.6	61.6	61	0.6	6	3
	5	□	MMS0340L-DIN	22.5	27.6	28.6	65.6	65	0.6	6	4
	5	●	MMS0340L-DIN-C	22.5	27.6	28.6	65.6	65	0.6	6	3

DC (mm)	Bohrtiefe (L/D)	DP7020	Bestellnummer	Abmessungen (mm)						Typ	
				LU	LCF	LH	OAL	LF	PL		DCOMMS
3.4	3	★	MMS0340X3DB	10.8	21.6	23.6	70.6	70	0.6	6	3
	5	★	MMS0340X5DB	17.6	28.6	31.6	78.6	78	0.6	6	3
3.5	3	□	MMS0350S-DIN	14.4	19.6	24.6	61.6	61	0.6	6	4
	3	●	MMS0350S-DIN-C	14.4	19.6	24.6	61.6	61	0.6	6	3
	5	□	MMS0350L-DIN	22.4	27.6	28.6	65.6	65	0.6	6	4
	5	●	MMS0350L-DIN-C	22.4	27.6	28.6	65.6	65	0.6	6	3
	3	★	MMS0350X3DB	11.1	21.6	23.6	70.6	70	0.6	6	3
	5	★	MMS0350X5DB	18.1	28.6	31.6	78.6	78	0.6	6	3
3.6	3	□	MMS0360S-DIN	14.3	19.7	24.7	61.7	61	0.7	6	4
	3	●	MMS0360S-DIN-C	14.3	19.7	24.7	61.7	61	0.7	6	3
	5	□	MMS0360L-DIN	22.3	27.7	28.7	65.7	65	0.7	6	4
	5	●	MMS0360L-DIN-C	22.3	27.7	28.7	65.7	65	0.7	6	3
	3	★	MMS0360X3DB	11.5	22.7	23.7	70.7	70	0.7	6	3
	5	★	MMS0360X5DB	18.7	30.7	31.7	78.7	78	0.7	6	3
3.7	3	□	MMS0370S-DIN	14.1	19.7	24.7	61.7	61	0.7	6	4
	3	●	MMS0370S-DIN-C	14.1	19.7	24.7	61.7	61	0.7	6	3
	5	□	MMS0370L-DIN	22.1	27.7	28.7	65.7	65	0.7	6	4
	5	●	MMS0370L-DIN-C	22.1	27.7	28.7	65.7	65	0.7	6	3
	3	★	MMS0370X3DB	11.8	22.7	23.7	70.7	70	0.7	6	3
	5	★	MMS0370X5DB	19.2	30.7	31.7	78.7	78	0.7	6	3
3.8	3	□	MMS0380S-DIN	18.0	23.7	28.7	65.7	65	0.7	6	4
	3	●	MMS0380S-DIN-C	18.0	23.7	28.7	65.7	65	0.7	6	3
	5	□	MMS0380L-DIN	30.0	35.7	36.7	73.7	73	0.7	6	4
	5	●	MMS0380L-DIN-C	30.0	35.7	36.7	73.7	73	0.7	6	3
	3	★	MMS0380X3DB	12.1	22.7	23.7	70.7	70	0.7	6	3
	5	★	MMS0380X5DB	19.7	30.7	31.7	78.7	78	0.7	6	3
3.9	3	□	MMS0390S-DIN	17.9	23.7	28.7	65.7	65	0.7	6	4
	3	●	MMS0390S-DIN-C	17.9	23.7	28.7	65.7	65	0.7	6	3
	5	□	MMS0390L-DIN	29.9	35.7	36.7	73.7	73	0.7	6	4
	5	●	MMS0390L-DIN-C	29.9	35.7	36.7	73.7	73	0.7	6	3
	3	★	MMS0390X3DB	12.4	22.7	23.7	70.7	70	0.7	6	3
	5	★	MMS0390X5DB	20.2	30.7	31.7	78.7	78	0.7	6	3

● : Lagerstandard. ★ : Lagerstandard in Japan.

□ : Herstellung nur auf Anfrage

DC	Bohrtiefe (mm)	DP7020 (L/D)	Bestellnummer	Abmessungen (mm)							Typ
				LU	LCF	LH	OAL	LF	PL	DCONMS	
4.0	3	□	MMS0400S-DIN	17.7	23.7	28.7	65.7	65	0.7	6	4
	3	●	MMS0400S-DIN-C	17.7	23.7	28.7	65.7	65	0.7	6	3
	5	□	MMS0400L-DIN	29.7	35.7	36.7	73.7	73	0.7	6	4
	5	●	MMS0400L-DIN-C	29.7	35.7	36.7	73.7	73	0.7	6	3
	3	★	MMS0400X3DB	12.7	22.7	23.7	70.7	70	0.7	6	3
	5	★	MMS0400X5DB	20.7	30.7	31.7	78.7	78	0.7	6	3
4.05	3	□	MMS0405S-DIN	17.7	23.7	28.7	65.7	65	0.7	6	4
	3	●	MMS0405S-DIN-C	17.7	23.7	28.7	65.7	65	0.7	6	3
	5	□	MMS0405L-DIN	29.7	35.7	36.7	73.7	73	0.7	6	4
	5	●	MMS0405L-DIN-C	29.7	35.7	36.7	73.7	73	0.7	6	3
4.1	3	□	MMS0410S-DIN	17.6	23.7	28.7	65.7	65	0.7	6	4
	3	●	MMS0410S-DIN-C	17.6	23.7	28.7	65.7	65	0.7	6	3
	5	□	MMS0410L-DIN	29.6	35.7	36.7	73.7	73	0.7	6	4
	5	●	MMS0410L-DIN-C	29.6	35.7	36.7	73.7	73	0.7	6	3
	3	★	MMS0410X3DB	13.0	24.7	26.7	73.7	73	0.7	6	3
5	★	MMS0410X5DB	21.2	33.7	35.7	82.7	82	0.7	6	3	
4.2	3	□	MMS0420S-DIN	17.5	23.8	28.8	65.8	65	0.8	6	4
	3	●	MMS0420S-DIN-C	17.5	23.8	28.8	65.8	65	0.8	6	3
	5	□	MMS0420L-DIN	29.5	35.8	36.8	73.8	73	0.8	6	4
	5	●	MMS0420L-DIN-C	29.5	35.8	36.8	73.8	73	0.8	6	3
	3	★	MMS0420X3DB	13.4	24.8	26.8	73.8	73	0.8	6	3
5	★	MMS0420X5DB	21.8	33.8	35.8	82.8	82	0.8	6	3	
4.3	3	□	MMS0430S-DIN	17.3	23.8	28.8	65.8	65	0.8	6	4
	3	●	MMS0430S-DIN-C	17.3	23.8	28.8	65.8	65	0.8	6	3
	5	□	MMS0430L-DIN	29.3	35.8	36.8	73.8	73	0.8	6	4
	5	●	MMS0430L-DIN-C	29.3	35.8	36.8	73.8	73	0.8	6	3
	3	★	MMS0430X3DB	13.7	24.8	26.8	73.8	73	0.8	6	3
	5	★	MMS0430X5DB	22.3	33.8	35.8	82.8	82	0.8	6	3
4.4	3	□	MMS0440S-DIN	17.2	23.8	28.8	65.8	65	0.8	6	4
	3	●	MMS0440S-DIN-C	17.2	23.8	28.8	65.8	65	0.8	6	3
	5	□	MMS0440L-DIN	29.2	35.8	36.8	73.8	73	0.8	6	4
	5	●	MMS0440L-DIN-C	29.2	35.8	36.8	73.8	73	0.8	6	3
	3	★	MMS0440X3DB	14.0	24.8	26.8	73.8	73	0.8	6	3
	5	★	MMS0440X5DB	22.8	33.8	35.8	82.8	82	0.8	6	3
4.5	3	□	MMS0450S-DIN	17.1	23.8	28.8	65.8	65	0.8	6	4
	3	●	MMS0450S-DIN-C	17.1	23.8	28.8	65.8	65	0.8	6	3
	5	□	MMS0450L-DIN	29.1	35.8	36.8	73.8	73	0.8	6	4
	5	●	MMS0450L-DIN-C	29.1	35.8	36.8	73.8	73	0.8	6	3
	3	★	MMS0450X3DB	14.3	24.8	26.8	73.8	73	0.8	6	3
	5	★	MMS0450X5DB	23.3	33.8	35.8	82.8	82	0.8	6	3
4.6	3	□	MMS0460S-DIN	16.9	23.8	28.8	65.8	65	0.8	6	2
	3	●	MMS0460S-DIN-C	16.9	23.8	28.8	65.8	65	0.8	6	1
	5	□	MMS0460L-DIN	28.9	35.8	36.8	73.8	73	0.8	6	2
	5	●	MMS0460L-DIN-C	28.9	35.8	36.8	73.8	73	0.8	6	1
	3	★	MMS0460X3DB	14.6	25.8	28.8	75.8	75	0.8	6	1
	5	★	MMS0460X5DB	23.8	35.8	38.8	85.8	85	0.8	6	1
4.65	3	□	MMS0465S-DIN	16.9	23.8	28.8	65.8	65	0.8	6	2
	3	●	MMS0465S-DIN-C	16.9	23.8	28.8	65.8	65	0.8	6	1
	5	□	MMS0465L-DIN	28.9	35.8	36.8	73.8	73	0.8	6	2
	5	●	MMS0465L-DIN-C	28.9	35.8	36.8	73.8	73	0.8	6	1

DC	Bohrtiefe (mm)	DP7020 (L/D)	Bestellnummer	Abmessungen (mm)							Typ
				LU	LCF	LH	OAL	LF	PL	DCONMS	
4.7	3	□	MMS0470S-DIN	16.8	23.9	28.9	65.9	65	0.9	6	2
	3	●	MMS0470S-DIN-C	16.8	23.9	28.9	65.9	65	0.9	6	1
	5	□	MMS0470L-DIN	28.8	35.9	36.9	73.9	73	0.9	6	2
	5	●	MMS0470L-DIN-C	28.8	35.9	36.9	73.9	73	0.9	6	1
	3	★	MMS0470X3DB	15.0	25.9	28.9	75.9	75	0.9	6	1
	5	★	MMS0470X5DB	24.4	35.9	38.9	85.9	85	0.9	6	1
4.8	3	□	MMS0480S-DIN	20.7	27.9	28.9	65.9	65	0.9	6	2
	3	●	MMS0480S-DIN-C	20.7	27.9	28.9	65.9	65	0.9	6	1
	5	□	MMS0480L-DIN	36.7	43.9	44.9	81.9	81	0.9	6	2
	5	●	MMS0480L-DIN-C	36.7	43.9	44.9	81.9	81	0.9	6	1
	3	★	MMS0480X3DB	15.3	25.9	28.9	75.9	75	0.9	6	1
	5	★	MMS0480X5DB	24.9	35.9	38.9	85.9	85	0.9	6	1
4.9	3	□	MMS0490S-DIN	20.5	27.9	28.9	65.9	65	0.9	6	2
	3	●	MMS0490S-DIN-C	20.5	27.9	28.9	65.9	65	0.9	6	1
	5	□	MMS0490L-DIN	36.5	43.9	44.9	81.9	81	0.9	6	2
	5	●	MMS0490L-DIN-C	36.5	43.9	44.9	81.9	81	0.9	6	1
	3	★	MMS0490X3DB	15.6	25.9	28.9	75.9	75	0.9	6	1
	5	★	MMS0490X5DB	25.4	35.9	38.9	85.9	85	0.9	6	1
5.0	3	□	MMS0500S-DIN	20.4	27.9	28.9	65.9	65	0.9	6	2
	3	●	MMS0500S-DIN-C	20.4	27.9	28.9	65.9	65	0.9	6	1
	5	□	MMS0500L-DIN	36.4	43.9	44.9	81.9	81	0.9	6	2
	5	●	MMS0500L-DIN-C	36.4	43.9	44.9	81.9	81	0.9	6	1
	3	★	MMS0500X3DB	15.9	25.9	28.9	75.9	75	0.9	6	1
	5	★	MMS0500X5DB	25.9	35.9	38.9	85.9	85	0.9	6	1
5.05	3	□	MMS0505S-DIN	20.3	27.9	28.9	65.9	65	0.9	6	2
	3	●	MMS0505S-DIN-C	20.3	27.9	28.9	65.9	65	0.9	6	1
	5	□	MMS0505L-DIN	36.3	43.9	44.9	81.9	81	0.9	6	2
	5	●	MMS0505L-DIN-C	36.3	43.9	44.9	81.9	81	0.9	6	1
	3	★	MMS0505X3DB	16.2	28.9	30.9	81.9	81	0.9	6	1
	5	★	MMS0505X5DB	26.4	39.9	42.9	89.9	89	0.9	6	1
5.1	3	□	MMS0510S-DIN	20.3	27.9	28.9	65.9	65	0.9	6	2
	3	●	MMS0510S-DIN-C	20.3	27.9	28.9	65.9	65	0.9	6	1
	5	□	MMS0510L-DIN	36.3	43.9	44.9	81.9	81	0.9	6	2
	5	●	MMS0510L-DIN-C	36.3	43.9	44.9	81.9	81	0.9	6	1
	3	★	MMS0510X3DB	16.2	28.9	30.9	81.9	81	0.9	6	1
	5	★	MMS0510X5DB	26.4	39.9	42.9	89.9	89	0.9	6	1
5.2	3	□	MMS0520S-DIN	20.1	27.9	28.9	65.9	65	0.9	6	2
	3	●	MMS0520S-DIN-C	20.1	27.9	28.9	65.9	65	0.9	6	1
	5	□	MMS0520L-DIN	36.1	43.9	44.9	81.9	81	0.9	6	2
	5	●	MMS0520L-DIN-C	36.1	43.9	44.9	81.9	81	0.9	6	1
	3	★	MMS0520X3DB	16.5	28.9	30.9	81.9	81	0.9	6	1
	5	★	MMS0520X5DB	26.9	39.9	42.9	89.9	89	0.9	6	1
5.3	3	□	MMS0530S-DIN	20.0	28.0	29.0	66.0	65	1.0	6	2
	3	●	MMS0530S-DIN-C	20.0	28.0	29.0	66.0	65	1.0	6	1
	5	□	MMS0530L-DIN	36.0	44.0	45.0	82.0	81	1.0	6	2
	5	●	MMS0530L-DIN-C	36.0	44.0	45.0	82.0	81	1.0	6	1
	3	★	MMS0530X3DB	16.9	29.0	31.0	82.0	81	1.0	6	1
	5	★	MMS0530X5DB	27.5	40.0	43.0	90.0	89	1.0	6	1
5.4	3	□	MMS0540S-DIN	19.9	28.0	29.0	66.0	65	1.0	6	2
	3	●	MMS0540S-DIN-C	19.9	28.0	29.0	66.0	65	1.0	6	1
	5	□	MMS0540L-DIN	35.9	44.0	45.0	82.0	81	1.0	6	2
	5	●	MMS0540L-DIN-C	35.9	44.0	45.0	82.0	81	1.0	6	1
	3	★	MMS0540X3DB	17.2	29.0	31.0	82.0	81	1.0	6	1
	5	★	MMS0540X5DB	28.0	40.0	43.0	90.0	89	1.0	6	1

M

BOHREN

# MMS

M  
BOHREN

DC	Bohrtiefe (mm)	DP7020 (L/D)	Bestellnummer	Abmessungen (mm)							Typ
				LU	LCF	LH	OAL	LF	PL	DCONMS	
5.5	3	□	MMS0550S-DIN	19.8	28.0	29.0	66.0	65	1.0	6	2
	3	●	MMS0550S-DIN-C	19.8	28.0	29.0	66.0	65	1.0	6	1
	5	□	MMS0550L-DIN	35.8	44.0	45.0	82.0	81	1.0	6	2
	5	●	MMS0550L-DIN-C	35.8	44.0	45.0	82.0	81	1.0	6	1
	3	★	MMS0550X3DB	17.5	29.0	31.0	82.0	81	1.0	6	1
	5	★	MMS0550X5DB	28.5	40.0	43.0	90.0	89	1.0	6	1
5.55	3	□	MMS0555S-DIN	19.7	28.0	29.0	66.0	65	1.0	6	2
	3	●	MMS0555S-DIN-C	19.7	28.0	29.0	66.0	65	1.0	6	1
	5	●	MMS0555L-DIN-C	35.7	44.0	45.0	82.0	81	1.0	6	1
5.6	3	□	MMS0560S-DIN	19.6	28.0	29.0	66.0	65	1.0	6	2
	3	●	MMS0560S-DIN-C	19.6	28.0	29.0	66.0	65	1.0	6	1
	5	□	MMS0560L-DIN	35.6	44.0	45.0	82.0	81	1.0	6	2
	5	●	MMS0560L-DIN-C	35.6	44.0	45.0	82.0	81	1.0	6	1
	3	★	MMS0560X3DB	17.8	31.0	31.0	82.0	81	1.0	6	1
	5	★	MMS0560X5DB	29.0	43.0	43.0	90.0	89	1.0	6	1
5.7	3	□	MMS0570S-DIN	19.5	28.0	29.0	66.0	65	1.0	6	2
	3	●	MMS0570S-DIN-C	19.5	28.0	29.0	66.0	65	1.0	6	1
	5	□	MMS0570L-DIN	35.5	44.0	45.0	82.0	81	1.0	6	2
	5	●	MMS0570L-DIN-C	35.5	44.0	45.0	82.0	81	1.0	6	1
	3	★	MMS0570X3DB	18.1	31.0	31.0	82.0	81	1.0	6	1
	5	★	MMS0570X5DB	29.5	43.0	43.0	90.0	89	1.0	6	1
5.8	3	□	MMS0580S-DIN	19.4	28.1	29.1	66.1	65	1.1	6	2
	3	●	MMS0580S-DIN-C	19.4	28.1	29.1	66.1	65	1.1	6	1
	5	□	MMS0580L-DIN	35.4	44.1	45.1	82.1	81	1.1	6	2
	5	●	MMS0580L-DIN-C	35.4	44.1	45.1	82.1	81	1.1	6	1
	3	★	MMS0580X3DB	18.5	31.1	31.1	82.1	81	1.1	6	1
	5	★	MMS0580X5DB	30.1	43.1	43.1	90.1	89	1.1	6	1
5.9	3	□	MMS0590S-DIN	19.2	28.1	29.1	66.1	65	1.1	6	2
	3	□	MMS0590S-DIN-C	19.2	28.1	29.1	66.1	65	1.1	6	1
	5	□	MMS0590L-DIN	35.2	44.1	45.1	82.1	81	1.1	6	2
	5	□	MMS0590L-DIN-C	35.2	44.1	45.1	82.1	81	1.1	6	1
	3	★	MMS0590X3DB	18.8	31.1	31.1	82.1	81	1.1	6	1
	5	★	MMS0590X5DB	30.6	43.1	43.1	90.1	89	1.1	6	1
6.0	3	□	MMS0600S-DIN	19.1	28.1	29.1	66.1	65	1.1	6	2
	3	●	MMS0600S-DIN-C	19.1	28.1	29.1	66.1	65	1.1	6	1
	5	□	MMS0600L-DIN	35.1	44.1	45.1	82.1	81	1.1	6	2
	5	●	MMS0600L-DIN-C	35.1	44.1	45.1	82.1	81	1.1	6	1
	3	★	MMS0600X3DB	19.1	31.1	31.1	82.1	81	1.1	6	1
	5	★	MMS0600X5DB	31.1	43.1	43.1	90.1	89	1.1	6	1
6.05	3	□	MMS0605S-DIN	25.0	34.1	42.1	79.1	78	1.1	8	2
	3	●	MMS0605S-DIN-C	25.0	34.1	42.1	79.1	78	1.1	8	1
	5	□	MMS0605L-DIN	44.0	53.1	54.1	91.1	90	1.1	8	2
	5	●	MMS0605L-DIN-C	44.0	53.1	54.1	91.1	90	1.1	8	1
6.1	3	□	MMS0610S-DIN	25.0	34.1	42.1	79.1	78	1.1	8	2
	3	●	MMS0610S-DIN-C	25.0	34.1	42.1	79.1	78	1.1	8	1
	5	□	MMS0610L-DIN	44.0	53.1	54.1	91.1	90	1.1	8	2
	5	●	MMS0610L-DIN-C	44.0	53.1	54.1	91.1	90	1.1	8	1
	3	★	MMS0610X3DB	19.4	34.1	36.1	87.1	86	1.1	8	1
	5	★	MMS0610X5DB	31.6	47.1	49.1	96.1	95	1.1	8	1

DC	Bohrtiefe (mm)	DP7020 (L/D)	Bestellnummer	Abmessungen (mm)							Typ
				LU	LCF	LH	OAL	LF	PL	DCONMS	
6.2	3	□	MMS0620S-DIN	24.8	34.1	42.1	79.1	78	1.1	8	2
	3	●	MMS0620S-DIN-C	24.8	34.1	42.1	79.1	78	1.1	8	1
	5	□	MMS0620L-DIN	43.8	53.1	54.1	91.1	90	1.1	8	2
	5	●	MMS0620L-DIN-C	43.8	53.1	54.1	91.1	90	1.1	8	1
	3	★	MMS0620X3DB	19.7	34.1	36.1	87.1	86	1.1	8	1
	5	★	MMS0620X5DB	32.1	47.1	49.1	96.1	95	1.1	8	1
6.3	3	□	MMS0630S-DIN	24.7	34.1	42.1	79.1	78	1.1	8	2
	3	□	MMS0630S-DIN-C	24.7	34.1	42.1	79.1	78	1.1	8	1
	5	□	MMS0630L-DIN	43.7	53.1	54.1	91.1	90	1.1	8	2
	5	□	MMS0630L-DIN-C	43.7	53.1	54.1	91.1	90	1.1	8	1
	3	★	MMS0630X3DB	20.0	34.1	36.1	87.1	86	1.1	8	1
	5	★	MMS0630X5DB	32.6	47.1	49.1	96.1	95	1.1	8	1
6.4	3	□	MMS0640S-DIN	24.6	34.2	42.2	79.2	78	1.2	8	2
	3	□	MMS0640S-DIN-C	24.6	34.2	42.2	79.2	78	1.2	8	1
	5	□	MMS0640L-DIN	43.6	53.2	54.2	91.2	90	1.2	8	2
	5	□	MMS0640L-DIN-C	43.6	53.2	54.2	91.2	90	1.2	8	1
	3	★	MMS0640X3DB	20.4	34.2	36.2	87.2	86	1.2	8	1
	5	★	MMS0640X5DB	33.2	47.2	49.2	96.2	95	1.2	8	1
6.5	3	□	MMS0650S-DIN	24.4	34.2	42.2	79.2	78	1.2	8	2
	3	●	MMS0650S-DIN-C	24.4	34.2	42.2	79.2	78	1.2	8	1
	5	□	MMS0650L-DIN	43.4	53.2	54.2	91.2	90	1.2	8	2
	5	●	MMS0650L-DIN-C	43.4	53.2	54.2	91.2	90	1.2	8	1
	3	★	MMS0650X3DB	20.7	34.2	36.2	87.2	86	1.2	8	1
	5	★	MMS0650X5DB	33.7	47.2	49.2	96.2	95	1.2	8	1
6.6	3	□	MMS0660S-DIN	24.3	34.2	42.2	79.2	78	1.2	8	2
	3	●	MMS0660S-DIN-C	24.3	34.2	42.2	79.2	78	1.2	8	1
	5	□	MMS0660L-DIN	43.3	53.2	54.2	91.2	90	1.2	8	2
	5	●	MMS0660L-DIN-C	43.3	53.2	54.2	91.2	90	1.2	8	1
	3	★	MMS0660X3DB	21.0	36.2	38.2	91.2	90	1.2	8	1
	5	★	MMS0660X5DB	34.2	50.2	52.2	99.2	98	1.2	8	1
6.7	3	□	MMS0670S-DIN	24.2	34.2	42.2	79.2	78	1.2	8	2
	3	□	MMS0670S-DIN-C	24.2	34.2	42.2	79.2	78	1.2	8	1
	5	□	MMS0670L-DIN	43.2	53.2	54.2	91.2	90	1.2	8	2
	5	□	MMS0670L-DIN-C	43.2	53.2	54.2	91.2	90	1.2	8	1
	3	★	MMS0670X3DB	21.3	36.2	38.2	91.2	90	1.2	8	1
	5	★	MMS0670X5DB	34.7	50.2	52.2	99.2	98	1.2	8	1
6.8	3	□	MMS0680S-DIN	24.0	34.2	42.2	79.2	78	1.2	8	2
	3	●	MMS0680S-DIN-C	24.0	34.2	42.2	79.2	78	1.2	8	1
	5	□	MMS0680L-DIN	43.0	53.2	54.2	91.2	90	1.2	8	2
	5	●	MMS0680L-DIN-C	43.0	53.2	54.2	91.2	90	1.2	8	1
	3	★	MMS0680X3DB	21.6	36.2	38.2	91.2	90	1.2	8	1
	5	★	MMS0680X5DB	35.2	50.2	52.2	99.2	98	1.2	8	1
6.9	3	□	MMS0690S-DIN	23.9	34.3	42.3	79.3	78	1.3	8	2
	3	●	MMS0690S-DIN-C	23.9	34.3	42.3	79.3	78	1.3	8	1
	5	□	MMS0690L-DIN	42.9	53.3	54.3	91.3	90	1.3	8	2
	5	●	MMS0690L-DIN-C	42.9	53.3	54.3	91.3	90	1.3	8	1
	3	★	MMS0690X3DB	22.0	36.3	38.3	91.3	90	1.3	8	1
	5	★	MMS0690X5DB	35.8	50.3	52.3	99.3	98	1.3	8	1

● : Lagerstandard. ★ : Lagerstandard in Japan.

□ : Herstellung nur auf Anfrage

DC	Bohrtiefe (mm)	Bohrtiefe (L/D)	DP7020	Bestellnummer	Abmessungen (mm)							Typ
					LU	LCF	LH	OAL	LF	PL	DCONMS	
7.0	3	□		MMS0700S-DIN	23.8	34.3	42.3	79.3	78	1.3	8	2
	3	●		MMS0700S-DIN-C	23.8	34.3	42.3	79.3	78	1.3	8	1
	5	□		MMS0700L-DIN	42.8	53.3	54.3	91.3	90	1.3	8	2
	5	●		MMS0700L-DIN-C	42.8	53.3	54.3	91.3	90	1.3	8	1
	3	★		MMS0700X3DB	22.3	36.3	38.3	91.3	90	1.3	8	1
	5	★		MMS0700X5DB	36.3	50.3	52.3	99.3	98	1.3	8	1
7.1	3	□		MMS0710S-DIN	30.6	41.3	42.3	79.3	78	1.3	8	2
	3	□		MMS0710S-DIN-C	30.6	41.3	42.3	79.3	78	1.3	8	1
	5	□		MMS0710L-DIN	42.6	53.3	54.3	91.3	90	1.3	8	2
	5	□		MMS0710L-DIN-C	42.6	53.3	54.3	91.3	90	1.3	8	1
	3	★		MMS0710X3DB	22.6	39.3	40.3	91.3	90	1.3	8	1
	5	★		MMS0710X5DB	36.8	54.3	57.3	104.3	103	1.3	8	1
7.2	3	□		MMS0720S-DIN	30.5	41.3	42.3	79.3	78	1.3	8	2
	3	□		MMS0720S-DIN-C	30.5	41.3	42.3	79.3	78	1.3	8	1
	5	□		MMS0720L-DIN	42.5	53.3	54.3	91.3	90	1.3	8	2
	5	□		MMS0720L-DIN-C	42.5	53.3	54.3	91.3	90	1.3	8	1
	3	★		MMS0720X3DB	22.9	39.3	40.3	91.3	90	1.3	8	1
	5	★		MMS0720X5DB	37.3	54.3	57.3	104.3	103	1.3	8	1
7.3	3	□		MMS0730S-DIN	30.4	41.3	42.3	79.3	78	1.3	8	2
	3	●		MMS0730S-DIN-C	30.4	41.3	42.3	79.3	78	1.3	8	1
	5	□		MMS0730L-DIN	42.4	53.3	54.3	91.3	90	1.3	8	2
	5	●		MMS0730L-DIN-C	42.4	53.3	54.3	91.3	90	1.3	8	1
	3	★		MMS0730X3DB	23.2	39.3	40.3	91.3	90	1.3	8	1
	5	★		MMS0730X5DB	37.8	54.3	57.3	104.3	103	1.3	8	1
7.4	3	□		MMS0740S-DIN	30.2	41.3	42.3	79.3	78	1.3	8	2
	3	●		MMS0740S-DIN-C	30.2	41.3	42.3	79.3	78	1.3	8	1
	5	□		MMS0740L-DIN	42.2	53.3	54.3	91.3	90	1.3	8	2
	5	●		MMS0740L-DIN-C	42.2	53.3	54.3	91.3	90	1.3	8	1
	3	★		MMS0740X3DB	23.5	39.3	40.3	91.3	90	1.3	8	1
	5	★		MMS0740X5DB	38.3	54.3	57.3	104.3	103	1.3	8	1
7.5	3	□		MMS0750S-DIN	30.1	41.4	42.4	79.4	78	1.4	8	2
	3	●		MMS0750S-DIN-C	30.1	41.4	42.4	79.4	78	1.4	8	1
	5	□		MMS0750L-DIN	42.1	53.4	54.4	91.4	90	1.4	8	2
	5	●		MMS0750L-DIN-C	42.1	53.4	54.4	91.4	90	1.4	8	1
	3	★		MMS0750X3DB	23.9	39.4	40.4	91.4	90	1.4	8	1
	5	★		MMS0750X5DB	38.9	54.4	57.4	104.4	103	1.4	8	1
7.6	3	□		MMS0760S-DIN	30.0	41.4	42.4	79.4	78	1.4	8	2
	3	□		MMS0760S-DIN-C	30.0	41.4	42.4	79.4	78	1.4	8	1
	5	□		MMS0760L-DIN	42.0	53.4	54.4	91.4	90	1.4	8	2
	5	□		MMS0760L-DIN-C	42.0	53.4	54.4	91.4	90	1.4	8	1
	3	★		MMS0760X3DB	24.2	41.4	41.4	91.4	90	1.4	8	1
	5	★		MMS0760X5DB	39.4	57.4	57.4	104.4	103	1.4	8	1
7.7	3	□		MMS0770S-DIN	29.9	41.4	42.4	79.4	78	1.4	8	2
	3	□		MMS0770S-DIN-C	29.9	41.4	42.4	79.4	78	1.4	8	1
	5	□		MMS0770L-DIN	41.9	53.4	54.4	91.4	90	1.4	8	2
	5	□		MMS0770L-DIN-C	41.9	53.4	54.4	91.4	90	1.4	8	1
	3	★		MMS0770X3DB	24.5	41.4	41.4	91.4	90	1.4	8	1
	5	★		MMS0770X5DB	39.9	57.4	57.4	104.4	103	1.4	8	1

DC	Bohrtiefe (mm)	Bohrtiefe (L/D)	DP7020	Bestellnummer	Abmessungen (mm)							Typ	
					LU	LCF	LH	OAL	LF	PL	DCONMS		
7.8	3	□		MMS0780S-DIN	29.7	41.4	42.4	79.4	78	1.4	8	2	
	3	●		MMS0780S-DIN-C	29.7	41.4	42.4	79.4	78	1.4	8	1	
	5	□		MMS0780L-DIN	41.7	53.4	54.4	91.4	90	1.4	8	2	
	5	●		MMS0780L-DIN-C	41.7	53.4	54.4	91.4	90	1.4	8	1	
	3	★		MMS0780X3DB	24.8	41.4	41.4	91.4	90	1.4	8	1	
	5	★		MMS0780X5DB	40.4	57.4	57.4	104.4	103	1.4	8	1	
7.9	3	□		MMS0790S-DIN	29.6	41.4	42.4	79.4	78	1.4	8	2	
	3	□		MMS0790S-DIN-C	29.6	41.4	42.4	79.4	78	1.4	8	1	
	5	□		MMS0790L-DIN	41.6	53.4	54.4	91.4	90	1.4	8	2	
	5	□		MMS0790L-DIN-C	41.6	53.4	54.4	91.4	90	1.4	8	1	
	3	★		MMS0790X3DB	25.1	41.4	41.4	91.4	90	1.4	8	1	
	5	★		MMS0790X5DB	40.9	57.4	57.4	104.4	103	1.4	8	1	
8.0	3	□		MMS0800S-DIN	29.5	41.5	42.5	79.5	78	1.5	8	2	
	3	●		MMS0800S-DIN-C	29.5	41.5	42.5	79.5	78	1.5	8	1	
	5	□		MMS0800L-DIN	41.5	53.5	54.5	91.5	90	1.5	8	2	
	5	●		MMS0800L-DIN-C	41.5	53.5	54.5	91.5	90	1.5	8	1	
	3	★		MMS0800X3DB	25.5	41.5	41.5	91.5	90	1.5	8	1	
	5	★		MMS0800X5DB	41.5	57.5	57.5	104.5	103	1.5	8	1	
8.05	3	□		MMS0805S-DIN	34.4	46.5	47.5	88.5	87	1.5	10	2	
	3	●		MMS0805S-DIN-C	34.4	46.5	47.5	88.5	87	1.5	10	1	
	5	□		MMS0805L-DIN	48.4	60.5	61.5	102.5	101	1.5	10	2	
	5	●		MMS0805L-DIN-C	48.4	60.5	61.5	102.5	101	1.5	10	1	
	8.1	3	□		MMS0810S-DIN	34.3	46.5	47.5	88.5	87	1.5	10	2
		3	□		MMS0810S-DIN-C	34.3	46.5	47.5	88.5	87	1.5	10	1
5		□		MMS0810L-DIN	48.3	60.5	61.5	102.5	101	1.5	10	2	
5		□		MMS0810L-DIN-C	48.3	60.5	61.5	102.5	101	1.5	10	1	
3		★		MMS0810X3DB	25.8	44.5	46.5	97.5	96	1.5	10	1	
5		★		MMS0810X5DB	42.0	61.5	63.5	114.5	113	1.5	10	1	
8.2	3	□		MMS0820S-DIN	34.2	46.5	47.5	88.5	87	1.5	10	2	
	3	□		MMS0820S-DIN-C	34.2	46.5	47.5	88.5	87	1.5	10	1	
	5	□		MMS0820L-DIN	48.2	60.5	61.5	102.5	101	1.5	10	2	
	5	□		MMS0820L-DIN-C	48.2	60.5	61.5	102.5	101	1.5	10	1	
	3	★		MMS0820X3DB	26.1	44.5	46.5	97.5	96	1.5	10	1	
	5	★		MMS0820X5DB	42.5	61.5	63.5	114.5	113	1.5	10	1	
8.3	3	□		MMS0830S-DIN	34.1	46.5	47.5	88.5	87	1.5	10	2	
	3	●		MMS0830S-DIN-C	34.1	46.5	47.5	88.5	87	1.5	10	1	
	5	□		MMS0830L-DIN	48.1	60.5	61.5	102.5	101	1.5	10	2	
	5	●		MMS0830L-DIN-C	48.1	60.5	61.5	102.5	101	1.5	10	1	
	3	★		MMS0830X3DB	26.4	44.5	46.5	97.5	96	1.5	10	1	
	5	★		MMS0830X5DB	43.0	61.5	63.5	114.5	113	1.5	10	1	
8.4	3	□		MMS0840S-DIN	33.9	46.5	47.5	88.5	87	1.5	10	2	
	3	□		MMS0840S-DIN-C	33.9	46.5	47.5	88.5	87	1.5	10	1	
	5	□		MMS0840L-DIN	47.9	60.5	61.5	102.5	101	1.5	10	2	
	5	□		MMS0840L-DIN-C	47.9	60.5	61.5	102.5	101	1.5	10	1	
	3	★		MMS0840X3DB	26.7	44.5	46.5	97.5	96	1.5	10	1	
	5	★		MMS0840X5DB	43.5	61.5	63.5	114.5	113	1.5	10	1	
8.5	3	□		MMS0850S-DIN	33.8	46.5	47.5	88.5	87	1.5	10	2	
	3	●		MMS0850S-DIN-C	33.8	46.5	47.5	88.5	87	1.5	10	1	
	5	□		MMS0850L-DIN	47.8	60.5	61.5	102.5	101	1.5	10	2	
	5	●		MMS0850L-DIN-C	47.8	60.5	61.5	102.5	101	1.5	10	1	
	3	★		MMS0850X3DB	27.0	44.5	46.5	97.5	96	1.5	10	1	
	5	★		MMS0850X5DB	44.0	61.5	63.5	114.5	113	1.5	10	1	

M

BOHREN

DC	Bohrtiefe (mm)	DP7020 (L/D)	Bestellnummer	Abmessungen (mm)							Typ
				LU	LCF	LH	OAL	LF	PL	DCONMS	
8.6	3	□	MMS0860S-DIN	33.7	46.6	47.6	88.6	87	1.6	10	2
	3	●	MMS0860S-DIN-C	33.7	46.6	47.6	88.6	87	1.6	10	1
	5	□	MMS0860L-DIN	47.7	60.6	61.6	102.6	101	1.6	10	2
	5	●	MMS0860L-DIN-C	47.7	60.6	61.6	102.6	101	1.6	10	1
	3	★	MMS0860X3DB	27.4	46.6	48.6	102.6	101	1.6	10	1
	5	★	MMS0860X5DB	44.6	64.6	66.6	117.6	116	1.6	10	1
8.7	3	□	MMS0870S-DIN	33.5	46.6	47.6	88.6	87	1.6	10	2
	3	●	MMS0870S-DIN-C	33.5	46.6	47.6	88.6	87	1.6	10	1
	5	□	MMS0870L-DIN	47.5	60.6	61.6	102.6	101	1.6	10	2
	5	●	MMS0870L-DIN-C	47.5	60.6	61.6	102.6	101	1.6	10	1
	3	★	MMS0870X3DB	27.7	46.6	48.6	102.6	101	1.6	10	1
	5	★	MMS0870X5DB	45.1	64.6	66.6	117.6	116	1.6	10	1
8.8	3	□	MMS0880S-DIN	33.4	46.6	47.6	88.6	87	1.6	10	2
	3	●	MMS0880S-DIN-C	33.4	46.6	47.6	88.6	87	1.6	10	1
	5	□	MMS0880L-DIN	47.4	60.6	61.6	102.6	101	1.6	10	2
	5	●	MMS0880L-DIN-C	47.4	60.6	61.6	102.6	101	1.6	10	1
	3	★	MMS0880X3DB	28.0	46.6	48.6	102.6	101	1.6	10	1
	5	★	MMS0880X5DB	45.6	64.6	66.6	117.6	116	1.6	10	1
8.9	3	□	MMS0890S-DIN	33.3	46.6	47.6	88.6	87	1.6	10	2
	3	●	MMS0890S-DIN-C	33.3	46.6	47.6	88.6	87	1.6	10	1
	5	□	MMS0890L-DIN	47.3	60.6	61.6	102.6	101	1.6	10	2
	5	●	MMS0890L-DIN-C	47.3	60.6	61.6	102.6	101	1.6	10	1
	3	★	MMS0890X3DB	28.3	46.6	48.6	102.6	101	1.6	10	1
	5	★	MMS0890X5DB	46.1	64.6	66.6	117.6	116	1.6	10	1
9.0	3	□	MMS0900S-DIN	33.1	46.6	47.6	88.6	87	1.6	10	2
	3	●	MMS0900S-DIN-C	33.1	46.6	47.6	88.6	87	1.6	10	1
	5	□	MMS0900L-DIN	47.1	60.6	61.6	102.6	101	1.6	10	2
	5	●	MMS0900L-DIN-C	47.1	60.6	61.6	102.6	101	1.6	10	1
	3	★	MMS0900X3DB	28.6	46.6	48.6	102.6	101	1.6	10	1
	5	★	MMS0900X5DB	46.6	64.6	66.6	117.6	116	1.6	10	1
9.1	3	□	MMS0910S-DIN	33.0	46.7	47.7	88.7	87	1.7	10	2
	3	●	MMS0910S-DIN-C	33.0	46.7	47.7	88.7	87	1.7	10	1
	5	□	MMS0910L-DIN	47.0	60.7	61.7	102.7	101	1.7	10	2
	5	●	MMS0910L-DIN-C	47.0	60.7	61.7	102.7	101	1.7	10	1
	3	★	MMS0910X3DB	29.0	49.7	51.7	102.7	101	1.7	10	1
	5	★	MMS0910X5DB	47.2	68.7	71.7	122.7	121	1.7	10	1
9.2	3	□	MMS0920S-DIN	32.9	46.7	47.7	88.7	87	1.7	10	2
	3	●	MMS0920S-DIN-C	32.9	46.7	47.7	88.7	87	1.7	10	1
	5	□	MMS0920L-DIN	46.9	60.7	61.7	102.7	101	1.7	10	2
	5	●	MMS0920L-DIN-C	46.9	60.7	61.7	102.7	101	1.7	10	1
	3	★	MMS0920X3DB	29.3	49.7	51.7	102.7	101	1.7	10	1
	5	★	MMS0920X5DB	47.7	68.7	71.7	122.7	121	1.7	10	1
9.3	3	□	MMS0930S-DIN	32.7	46.7	47.7	88.7	87	1.7	10	2
	3	●	MMS0930S-DIN-C	32.7	46.7	47.7	88.7	87	1.7	10	1
	5	□	MMS0930L-DIN	46.7	60.7	61.7	102.7	101	1.7	10	2
	5	●	MMS0930L-DIN-C	46.7	60.7	61.7	102.7	101	1.7	10	1
	3	★	MMS0930X3DB	29.6	49.7	51.7	102.7	101	1.7	10	1
	5	★	MMS0930X5DB	48.2	68.7	71.7	122.7	121	1.7	10	1

DC	Bohrtiefe (mm)	DP7020 (L/D)	Bestellnummer	Abmessungen (mm)							Typ
				LU	LCF	LH	OAL	LF	PL	DCONMS	
9.4	3	□	MMS0940S-DIN	32.6	46.7	47.7	88.7	87	1.7	10	2
	3	●	MMS0940S-DIN-C	32.6	46.7	47.7	88.7	87	1.7	10	1
	5	□	MMS0940L-DIN	46.6	60.7	61.7	102.7	101	1.7	10	2
	5	●	MMS0940L-DIN-C	46.6	60.7	61.7	102.7	101	1.7	10	1
	3	★	MMS0940X3DB	29.9	49.7	51.7	102.7	101	1.7	10	1
	5	★	MMS0940X5DB	48.7	68.7	71.7	122.7	121	1.7	10	1
9.5	3	□	MMS0950S-DIN	32.5	46.7	47.7	88.7	87	1.7	10	2
	3	●	MMS0950S-DIN-C	32.5	46.7	47.7	88.7	87	1.7	10	1
	5	□	MMS0950L-DIN	46.5	60.7	61.7	102.7	101	1.7	10	2
	5	●	MMS0950L-DIN-C	46.5	60.7	61.7	102.7	101	1.7	10	1
	3	★	MMS0950X3DB	30.2	49.7	51.7	102.7	101	1.7	10	1
	5	★	MMS0950X5DB	49.2	68.7	71.7	122.7	121	1.7	10	1
9.6	3	□	MMS0960S-DIN	32.3	46.7	47.7	88.7	87	1.7	10	2
	3	●	MMS0960S-DIN-C	32.3	46.7	47.7	88.7	87	1.7	10	1
	5	□	MMS0960L-DIN	46.3	60.7	61.7	102.7	101	1.7	10	2
	5	●	MMS0960L-DIN-C	46.3	60.7	61.7	102.7	101	1.7	10	1
	3	★	MMS0960X3DB	30.5	51.7	51.7	102.7	101	1.7	10	1
	5	★	MMS0960X5DB	49.7	71.7	71.7	122.7	121	1.7	10	1
9.7	3	□	MMS0970S-DIN	32.2	46.8	47.8	88.8	87	1.8	10	2
	3	●	MMS0970S-DIN-C	32.2	46.8	47.8	88.8	87	1.8	10	1
	5	□	MMS0970L-DIN	46.2	60.8	61.8	102.8	101	1.8	10	2
	5	●	MMS0970L-DIN-C	46.2	60.8	61.8	102.8	101	1.8	10	1
	3	★	MMS0970X3DB	30.9	51.8	51.8	102.8	101	1.8	10	1
	5	★	MMS0970X5DB	50.3	71.8	71.8	122.8	121	1.8	10	1
9.8	3	□	MMS0980S-DIN	32.1	46.8	47.8	88.8	87	1.8	10	2
	3	●	MMS0980S-DIN-C	32.1	46.8	47.8	88.8	87	1.8	10	1
	5	□	MMS0980L-DIN	46.1	60.8	61.8	102.8	101	1.8	10	2
	5	●	MMS0980L-DIN-C	46.1	60.8	61.8	102.8	101	1.8	10	1
	3	★	MMS0980X3DB	31.2	51.8	51.8	102.8	101	1.8	10	1
	5	★	MMS0980X5DB	50.8	71.8	71.8	122.8	121	1.8	10	1
9.9	3	□	MMS0990S-DIN	32.0	46.8	47.8	88.8	87	1.8	10	2
	3	●	MMS0990S-DIN-C	32.0	46.8	47.8	88.8	87	1.8	10	1
	5	□	MMS0990L-DIN	46.0	60.8	61.8	102.8	101	1.8	10	2
	5	●	MMS0990L-DIN-C	46.0	60.8	61.8	102.8	101	1.8	10	1
	3	★	MMS0990X3DB	31.5	51.8	51.8	102.8	101	1.8	10	1
	5	★	MMS0990X5DB	51.3	71.8	71.8	122.8	121	1.8	10	1
10.0	3	□	MMS1000S-DIN	31.8	46.8	47.8	88.8	87	1.8	10	2
	3	●	MMS1000S-DIN-C	31.8	46.8	47.8	88.8	87	1.8	10	1
	5	□	MMS1000L-DIN	45.8	60.8	61.8	102.8	101	1.8	10	2
	5	●	MMS1000L-DIN-C	45.8	60.8	61.8	102.8	101	1.8	10	1
	3	★	MMS1000X3DB	31.8	51.8	51.8	102.8	101	1.8	10	1
	5	★	MMS1000X5DB	51.8	71.8	71.8	122.8	121	1.8	10	1
10.05	3	□	MMS1005S-DIN	39.8	54.8	55.8	101.8	100	1.8	12	2
	3	●	MMS1005S-DIN-C	39.8	54.8	55.8	101.8	100	1.8	12	1
	5	□	MMS1005L-DIN	55.8	70.8	71.8	117.8	116	1.8	12	2
	5	●	MMS1005L-DIN-C	55.8	70.8	71.8	117.8	116	1.8	12	1

● : Lagerstandard. ★ : Lagerstandard in Japan.

□ : Herstellung nur auf Anfrage



DC	Bohrtiefe (mm)	Bohrtiefe (L/D)	DP7020	Bestellnummer	Abmessungen (mm)							Typ
					LU	LCF	LH	OAL	LF	PL	DCONMS	
10.1	3	□		MMS1010S-DIN	39.7	54.8	55.8	101.8	100	1.8	12	2
	3	□		MMS1010S-DIN-C	39.7	54.8	55.8	101.8	100	1.8	12	1
	5	□		MMS1010L-DIN	55.7	70.8	71.8	117.8	116	1.8	12	2
	5	□		MMS1010L-DIN-C	55.7	70.8	71.8	117.8	116	1.8	12	1
	3	★		MMS1010X3DB	32.1	54.8	56.8	112.8	111	1.8	12	1
	5	★		MMS1010X5DB	52.3	75.8	79.8	135.8	134	1.8	12	1
10.2	3	□		MMS1020S-DIN	39.6	54.9	55.9	101.9	100	1.9	12	2
	3	●		MMS1020S-DIN-C	39.6	54.9	55.9	101.9	100	1.9	12	1
	5	□		MMS1020L-DIN	55.6	70.9	71.9	117.9	116	1.9	12	2
	5	●		MMS1020L-DIN-C	55.6	70.9	71.9	117.9	116	1.9	12	1
	3	★		MMS1020X3DB	32.5	54.9	56.9	112.9	111	1.9	12	1
	5	★		MMS1020X5DB	52.9	75.9	79.9	135.9	134	1.9	12	1
10.3	3	□		MMS1030S-DIN	39.4	54.9	55.9	101.9	100	1.9	12	2
	3	●		MMS1030S-DIN-C	39.4	54.9	55.9	101.9	100	1.9	12	1
	5	□		MMS1030L-DIN	55.4	70.9	71.9	117.9	116	1.9	12	2
	5	●		MMS1030L-DIN-C	55.4	70.9	71.9	117.9	116	1.9	12	1
	3	★		MMS1030X3DB	32.8	54.9	56.9	112.9	111	1.9	12	1
	5	★		MMS1030X5DB	53.4	75.9	79.9	135.9	134	1.9	12	1
10.4	3	□		MMS1040S-DIN	39.3	54.9	55.9	101.9	100	1.9	12	2
	3	●		MMS1040S-DIN-C	39.3	54.9	55.9	101.9	100	1.9	12	1
	5	□		MMS1040L-DIN	55.3	70.9	71.9	117.9	116	1.9	12	2
	5	●		MMS1040L-DIN-C	55.3	70.9	71.9	117.9	116	1.9	12	1
	3	★		MMS1040X3DB	33.1	54.9	56.9	112.9	111	1.9	12	1
	5	★		MMS1040X5DB	53.9	75.9	79.9	135.9	134	1.9	12	1
10.5	3	□		MMS1050S-DIN	39.2	54.9	55.9	101.9	100	1.9	12	2
	3	●		MMS1050S-DIN-C	39.2	54.9	55.9	101.9	100	1.9	12	1
	5	□		MMS1050L-DIN	55.2	70.9	71.9	117.9	116	1.9	12	2
	5	●		MMS1050L-DIN-C	55.2	70.9	71.9	117.9	116	1.9	12	1
	3	★		MMS1050X3DB	33.4	54.9	56.9	112.9	111	1.9	12	1
	5	★		MMS1050X5DB	54.4	75.9	79.9	135.9	134	1.9	12	1
10.6	3	□		MMS1060S-DIN	39.0	54.9	55.9	101.9	100	1.9	12	2
	3	□		MMS1060S-DIN-C	39.0	54.9	55.9	101.9	100	1.9	12	1
	5	□		MMS1060L-DIN	55.0	70.9	71.9	117.9	116	1.9	12	2
	5	□		MMS1060L-DIN-C	55.0	70.9	71.9	117.9	116	1.9	12	1
	3	★		MMS1060X3DB	33.7	56.9	57.9	117.9	116	1.9	12	1
	5	★		MMS1060X5DB	54.9	78.9	79.9	135.9	134	1.9	12	1
10.7	3	□		MMS1070S-DIN	38.9	54.9	55.9	101.9	100	1.9	12	2
	3	●		MMS1070S-DIN-C	38.9	54.9	55.9	101.9	100	1.9	12	1
	5	□		MMS1070L-DIN	54.9	70.9	71.9	117.9	116	1.9	12	2
	5	●		MMS1070L-DIN-C	54.9	70.9	71.9	117.9	116	1.9	12	1
	3	★		MMS1070X3DB	34.0	56.9	57.9	117.9	116	1.9	12	1
	5	★		MMS1070X5DB	55.4	78.9	79.9	135.9	134	1.9	12	1
10.8	3	□		MMS1080S-DIN	38.8	55.0	56.0	102.0	100	2.0	12	2
	3	●		MMS1080S-DIN-C	38.8	55.0	56.0	102.0	100	2.0	12	1
	5	□		MMS1080L-DIN	54.8	71.0	72.0	118.0	116	2.0	12	2
	5	●		MMS1080L-DIN-C	54.8	71.0	72.0	118.0	116	2.0	12	1
	3	★		MMS1080X3DB	34.4	57.0	58.0	118.0	116	2.0	12	1
	5	★		MMS1080X5DB	56.0	79.0	80.0	136.0	134	2.0	12	1

DC	Bohrtiefe (mm)	Bohrtiefe (L/D)	DP7020	Bestellnummer	Abmessungen (mm)							Typ
					LU	LCF	LH	OAL	LF	PL	DCONMS	
10.9	3	□		MMS1090S-DIN	38.6	55.0	56.0	102.0	100	2.0	12	2
	3	□		MMS1090S-DIN-C	38.6	55.0	56.0	102.0	100	2.0	12	1
	5	□		MMS1090L-DIN	54.6	71.0	72.0	118.0	116	2.0	12	2
	5	□		MMS1090L-DIN-C	54.6	71.0	72.0	118.0	116	2.0	12	1
	3	★		MMS1090X3DB	34.7	57.0	58.0	118.0	116	2.0	12	1
	5	★		MMS1090X5DB	56.5	79.0	80.0	136.0	134	2.0	12	1
11.0	3	□		MMS1100S-DIN	38.5	55.0	56.0	102.0	100	2.0	12	2
	3	●		MMS1100S-DIN-C	38.5	55.0	56.0	102.0	100	2.0	12	1
	5	□		MMS1100L-DIN	54.5	71.0	72.0	118.0	116	2.0	12	2
	5	●		MMS1100L-DIN-C	54.5	71.0	72.0	118.0	116	2.0	12	1
	3	★		MMS1100X3DB	35.0	57.0	58.0	118.0	116	2.0	12	1
	5	★		MMS1100X5DB	57.0	79.0	80.0	136.0	134	2.0	12	1
11.1	3	□		MMS1110S-DIN	38.4	55.0	56.0	102.0	100	2.0	12	2
	3	□		MMS1110S-DIN-C	38.4	55.0	56.0	102.0	100	2.0	12	1
	5	□		MMS1110L-DIN	54.4	71.0	72.0	118.0	116	2.0	12	2
	5	□		MMS1110L-DIN-C	54.4	71.0	72.0	118.0	116	2.0	12	1
	3	★		MMS1110X3DB	35.3	60.0	62.0	118.0	116	2.0	12	1
	5	★		MMS1110X5DB	57.5	83.0	86.0	142.0	140	2.0	12	1
11.2	3	□		MMS1120S-DIN	38.2	55.0	56.0	102.0	100	2.0	12	2
	3	●		MMS1120S-DIN-C	38.2	55.0	56.0	102.0	100	2.0	12	1
	5	□		MMS1120L-DIN	54.2	71.0	72.0	118.0	116	2.0	12	2
	5	●		MMS1120L-DIN-C	54.2	71.0	72.0	118.0	116	2.0	12	1
	3	★		MMS1120X3DB	35.6	60.0	62.0	118.0	116	2.0	12	1
	5	★		MMS1120X5DB	58.0	83.0	86.0	142.0	140	2.0	12	1
11.3	3	□		MMS1130S-DIN	38.1	55.1	56.1	102.1	100	2.1	12	2
	3	□		MMS1130S-DIN-C	38.1	55.1	56.1	102.1	100	2.1	12	1
	5	□		MMS1130L-DIN	54.1	71.1	72.1	118.1	116	2.1	12	2
	5	□		MMS1130L-DIN-C	54.1	71.1	72.1	118.1	116	2.1	12	1
	3	★		MMS1130X3DB	36.0	60.1	62.1	118.1	116	2.1	12	1
	5	★		MMS1130X5DB	58.6	83.1	86.1	142.1	140	2.1	12	1
11.4	3	□		MMS1140S-DIN	38.0	55.1	56.1	102.1	100	2.1	12	2
	3	●		MMS1140S-DIN-C	38.0	55.1	56.1	102.1	100	2.1	12	1
	5	□		MMS1140L-DIN	54.0	71.1	72.1	118.1	116	2.1	12	2
	5	●		MMS1140L-DIN-C	54.0	71.1	72.1	118.1	116	2.1	12	1
	3	★		MMS1140X3DB	36.3	60.1	62.1	118.1	116	2.1	12	1
	5	★		MMS1140X5DB	59.1	83.1	86.1	142.1	140	2.1	12	1
11.5	3	□		MMS1150S-DIN	37.8	55.1	56.1	102.1	100	2.1	12	2
	3	●		MMS1150S-DIN-C	37.8	55.1	56.1	102.1	100	2.1	12	1
	5	□		MMS1150L-DIN	53.8	71.1	72.1	118.1	116	2.1	12	2
	5	●		MMS1150L-DIN-C	53.8	71.1	72.1	118.1	116	2.1	12	1
	3	★		MMS1150X3DB	36.6	60.1	62.1	118.1	116	2.1	12	1
	5	★		MMS1150X5DB	59.6	83.1	86.1	142.1	140	2.1	12	1
11.6	3	□		MMS1160S-DIN	37.7	55.1	56.1	102.1	100	2.1	12	2
	3	□		MMS1160S-DIN-C	37.7	55.1	56.1	102.1	100	2.1	12	1
	5	□		MMS1160L-DIN	53.7	71.1	72.1	118.1	116	2.1	12	2
	5	□		MMS1160L-DIN-C	53.7	71.1	72.1	118.1	116	2.1	12	1
	3	★		MMS1160X3DB	36.9	62.1	62.1	118.1	116	2.1	12	1
	5	★		MMS1160X5DB	60.1	86.1	86.1	142.1	140	2.1	12	1

M

BOHREN

# BOHREN (VOLLHARTMETALL)

# MMS

HARTMETALL

M  
BOHREN

DC	Bohrtiefe (mm)	DP7020 (L/D)	Bestellnummer	Abmessungen (mm)							Typ
				LU	LCF	LH	OAL	LF	PL	DCONMS	
11.7	3	□	MMS1170S-DIN	37.6	55.1	56.1	102.1	100	2.1	12	2
	3	●	MMS1170S-DIN-C	37.6	55.1	56.1	102.1	100	2.1	12	1
	5	□	MMS1170L-DIN	53.6	71.1	72.1	118.1	116	2.1	12	2
	5	●	MMS1170L-DIN-C	53.6	71.1	72.1	118.1	116	2.1	12	1
	3	★	MMS1170X3DB	37.2	62.1	62.1	118.1	116	2.1	12	1
	5	★	MMS1170X5DB	60.6	86.1	86.1	142.1	140	2.1	12	1
11.8	3	□	MMS1180S-DIN	37.4	55.1	56.1	102.1	100	2.1	12	2
	3	●	MMS1180S-DIN-C	37.4	55.1	56.1	102.1	100	2.1	12	1
	5	□	MMS1180L-DIN	53.4	71.1	72.1	118.1	116	2.1	12	2
	5	●	MMS1180L-DIN-C	53.4	71.1	72.1	118.1	116	2.1	12	1
	3	★	MMS1180X3DB	37.5	62.1	62.1	118.1	116	2.1	12	1
	5	★	MMS1180X5DB	61.1	86.1	86.1	142.1	140	2.1	12	1
11.9	3	□	MMS1190S-DIN	37.3	55.2	56.2	102.2	100	2.2	12	2
	3	□	MMS1190S-DIN-C	37.3	55.2	56.2	102.2	100	2.2	12	1
	5	□	MMS1190L-DIN	53.3	71.2	72.2	118.2	116	2.2	12	2
	5	□	MMS1190L-DIN-C	53.3	71.2	72.2	118.2	116	2.2	12	1
	3	★	MMS1190X3DB	37.9	62.2	62.2	118.2	116	2.2	12	1
	5	★	MMS1190X5DB	61.7	86.2	86.2	142.2	140	2.2	12	1
12.0	3	□	MMS1200S-DIN	37.2	55.2	56.2	102.2	100	2.2	12	2
	3	●	MMS1200S-DIN-C	37.2	55.2	56.2	102.2	100	2.2	12	1
	5	□	MMS1200L-DIN	53.2	71.2	72.2	118.2	116	2.2	12	2
	5	●	MMS1200L-DIN-C	53.2	71.2	72.2	118.2	116	2.2	12	1
	3	★	MMS1200X3DB	38.2	62.2	62.2	118.2	116	2.2	12	1
	5	★	MMS1200X5DB	62.2	86.2	86.2	142.2	140	2.2	12	1
12.05	3	□	MMS1205S-DIN	42.1	60.2	61.2	107.2	105	2.2	14	2
	3	●	MMS1205S-DIN-C	42.1	60.2	61.2	107.2	105	2.2	14	1
	5	□	MMS1205L-DIN	59.1	77.2	78.2	124.2	122	2.2	14	2
	5	●	MMS1205L-DIN-C	59.1	77.2	78.2	124.2	122	2.2	14	1
12.1	3	□	MMS1210S-DIN	42.1	60.2	61.2	107.2	105	2.2	14	2
	3	□	MMS1210S-DIN-C	42.1	60.2	61.2	107.2	105	2.2	14	1
	5	□	MMS1210L-DIN	59.1	77.2	78.2	124.2	122	2.2	14	2
	5	□	MMS1210L-DIN-C	59.1	77.2	78.2	124.2	122	2.2	14	1
	3	★	MMS1210X3DB	38.5	65.2	68.2	124.2	122	2.2	14	1
	5	★	MMS1210X5DB	62.7	90.2	94.2	150.2	148	2.2	14	1
12.2	3	□	MMS1220S-DIN	41.9	60.2	61.2	107.2	105	2.2	14	2
	3	□	MMS1220S-DIN-C	41.9	60.2	61.2	107.2	105	2.2	14	1
	5	□	MMS1220L-DIN	58.9	77.2	78.2	124.2	122	2.2	14	2
	5	□	MMS1220L-DIN-C	58.9	77.2	78.2	124.2	122	2.2	14	1
	3	★	MMS1220X3DB	38.8	65.2	68.2	124.2	122	2.2	14	1
	5	★	MMS1220X5DB	63.2	90.2	94.2	150.2	148	2.2	14	1
12.3	3	□	MMS1230S-DIN	41.8	60.2	61.2	107.2	105	2.2	14	2
	3	□	MMS1230S-DIN-C	41.8	60.2	61.2	107.2	105	2.2	14	1
	5	□	MMS1230L-DIN	58.8	77.2	78.2	124.2	122	2.2	14	2
	5	□	MMS1230L-DIN-C	58.8	77.2	78.2	124.2	122	2.2	14	1
	3	★	MMS1230X3DB	39.1	65.2	68.2	124.2	122	2.2	14	1
	5	★	MMS1230X5DB	63.7	90.2	94.2	150.2	148	2.2	14	1

DC	Bohrtiefe (mm)	DP7020 (L/D)	Bestellnummer	Abmessungen (mm)							Typ
				LU	LCF	LH	OAL	LF	PL	DCONMS	
12.4	3	□	MMS1240S-DIN	41.7	60.3	61.3	107.3	105	2.3	14	2
	3	□	MMS1240S-DIN-C	41.7	60.3	61.3	107.3	105	2.3	14	1
	5	□	MMS1240L-DIN	58.7	77.3	78.3	124.3	122	2.3	14	2
	5	□	MMS1240L-DIN-C	58.7	77.3	78.3	124.3	122	2.3	14	1
	3	★	MMS1240X3DB	39.5	65.3	68.3	124.3	122	2.3	14	1
	5	★	MMS1240X5DB	64.3	90.3	94.3	150.3	148	2.3	14	1
12.5	3	□	MMS1250S-DIN	41.5	60.3	61.3	107.3	105	2.3	14	2
	3	●	MMS1250S-DIN-C	41.5	60.3	61.3	107.3	105	2.3	14	1
	5	□	MMS1250L-DIN	58.5	77.3	78.3	124.3	122	2.3	14	2
	5	●	MMS1250L-DIN-C	58.5	77.3	78.3	124.3	122	2.3	14	1
	3	★	MMS1250X3DB	39.8	65.3	68.3	124.3	122	2.3	14	1
	5	★	MMS1250X5DB	64.8	90.3	94.3	150.3	148	2.3	14	1
12.6	3	□	MMS1260S-DIN	41.4	60.3	61.3	107.3	105	2.3	14	2
	3	●	MMS1260S-DIN-C	41.4	60.3	61.3	107.3	105	2.3	14	1
	5	□	MMS1260L-DIN	58.4	77.3	78.3	124.3	122	2.3	14	2
	5	●	MMS1260L-DIN-C	58.4	77.3	78.3	124.3	122	2.3	14	1
	3	★	MMS1260X3DB	40.1	67.3	68.3	124.3	122	2.3	14	1
	5	★	MMS1260X5DB	65.3	93.3	94.3	150.3	148	2.3	14	1
12.7	3	□	MMS1270S-DIN	41.3	60.3	61.3	107.3	105	2.3	14	2
	3	●	MMS1270S-DIN-C	41.3	60.3	61.3	107.3	105	2.3	14	1
	5	□	MMS1270L-DIN	58.3	77.3	78.3	124.3	122	2.3	14	2
	5	●	MMS1270L-DIN-C	58.3	77.3	78.3	124.3	122	2.3	14	1
	3	★	MMS1270X3DB	40.4	67.3	68.3	124.3	122	2.3	14	1
	5	★	MMS1270X5DB	65.8	93.3	94.3	150.3	148	2.3	14	1
12.8	3	□	MMS1280S-DIN	41.1	60.3	61.3	107.3	105	2.3	14	2
	3	□	MMS1280S-DIN-C	41.1	60.3	61.3	107.3	105	2.3	14	1
	5	□	MMS1280L-DIN	58.1	77.3	78.3	124.3	122	2.3	14	2
	5	□	MMS1280L-DIN-C	58.1	77.3	78.3	124.3	122	2.3	14	1
	3	★	MMS1280X3DB	40.7	67.3	68.3	124.3	122	2.3	14	1
	5	★	MMS1280X5DB	66.3	93.3	94.3	150.3	148	2.3	14	1
12.9	3	□	MMS1290S-DIN	41.0	60.3	61.3	107.3	105	2.3	14	2
	3	□	MMS1290S-DIN-C	41.0	60.3	61.3	107.3	105	2.3	14	1
	5	□	MMS1290L-DIN	58.0	77.3	78.3	124.3	122	2.3	14	2
	5	□	MMS1290L-DIN-C	58.0	77.3	78.3	124.3	122	2.3	14	1
	3	★	MMS1290X3DB	41.0	67.3	68.3	124.3	122	2.3	14	1
	5	★	MMS1290X5DB	66.8	93.3	94.3	150.3	148	2.3	14	1
13.0	3	□	MMS1300S-DIN	40.9	60.4	61.4	107.4	105	2.4	14	2
	3	●	MMS1300S-DIN-C	40.9	60.4	61.4	107.4	105	2.4	14	1
	5	□	MMS1300L-DIN	57.9	77.4	78.4	124.4	122	2.4	14	2
	5	●	MMS1300L-DIN-C	57.9	77.4	78.4	124.4	122	2.4	14	1
	3	★	MMS1300X3DB	41.4	67.4	68.4	124.4	122	2.4	14	1
	5	★	MMS1300X5DB	67.4	93.4	94.4	150.4	148	2.4	14	1
13.1	3	□	MMS1310S-DIN	40.7	60.4	61.4	107.4	105	2.4	14	2
	3	□	MMS1310S-DIN-C	40.7	60.4	61.4	107.4	105	2.4	14	1
	5	□	MMS1310L-DIN	57.7	77.4	78.4	124.4	122	2.4	14	2
	5	□	MMS1310L-DIN-C	57.7	77.4	78.4	124.4	122	2.4	14	1
	3	★	MMS1310X3DB	41.7	70.4	72.4	128.4	126	2.4	14	1
	5	★	MMS1310X5DB	67.9	97.4	100.4	156.4	154	2.4	14	1

● : Lagerstandard. ★ : Lagerstandard in Japan.

□ : Herstellung nur auf Anfrage

DC	Bohrtiefe (mm)	DP7020 (L/D)	Bestellnummer	Abmessungen (mm)							Typ
				LU	LCF	LH	OAL	LF	PL	DCONMS	
13.2	3	□	MMS1320S-DIN	40.6	60.4	61.4	107.4	105	2.4	14	2
	3	□	MMS1320S-DIN-C	40.6	60.4	61.4	107.4	105	2.4	14	1
	5	□	MMS1320L-DIN	57.6	77.4	78.4	124.4	122	2.4	14	2
	5	□	MMS1320L-DIN-C	57.6	77.4	78.4	124.4	122	2.4	14	1
	3	★	MMS1320X3DB	42.0	70.4	72.4	128.4	126	2.4	14	1
	5	★	MMS1320X5DB	68.4	97.4	100.4	156.4	154	2.4	14	1
13.3	3	□	MMS1330S-DIN	40.5	60.4	61.4	107.4	105	2.4	14	2
	3	□	MMS1330S-DIN-C	40.5	60.4	61.4	107.4	105	2.4	14	1
	5	□	MMS1330L-DIN	57.5	77.4	78.4	124.4	122	2.4	14	2
	5	□	MMS1330L-DIN-C	57.5	77.4	78.4	124.4	122	2.4	14	1
	3	★	MMS1330X3DB	42.3	70.4	72.4	128.4	126	2.4	14	1
	5	★	MMS1330X5DB	68.9	97.4	100.4	156.4	154	2.4	14	1
13.4	3	□	MMS1340S-DIN	40.3	60.4	61.4	107.4	105	2.4	14	2
	3	□	MMS1340S-DIN-C	40.3	60.4	61.4	107.4	105	2.4	14	1
	5	□	MMS1340L-DIN	57.3	77.4	78.4	124.4	122	2.4	14	2
	5	□	MMS1340L-DIN-C	57.3	77.4	78.4	124.4	122	2.4	14	1
	3	★	MMS1340X3DB	42.6	70.4	72.4	128.4	126	2.4	14	1
	5	★	MMS1340X5DB	69.4	97.4	100.4	156.4	154	2.4	14	1
13.5	3	□	MMS1350S-DIN	40.2	60.5	61.5	107.5	105	2.5	14	2
	3	●	MMS1350S-DIN-C	40.2	60.5	61.5	107.5	105	2.5	14	1
	5	□	MMS1350L-DIN	57.2	77.5	78.5	124.5	122	2.5	14	2
	5	●	MMS1350L-DIN-C	57.2	77.5	78.5	124.5	122	2.5	14	1
	3	★	MMS1350X3DB	43.0	70.5	72.5	128.5	126	2.5	14	1
	5	★	MMS1350X5DB	70.0	97.5	100.5	156.5	154	2.5	14	1
13.6	3	□	MMS1360S-DIN	40.1	60.5	61.5	107.5	105	2.5	14	2
	3	□	MMS1360S-DIN-C	40.1	60.5	61.5	107.5	105	2.5	14	1
	5	□	MMS1360L-DIN	57.1	77.5	78.5	124.5	122	2.5	14	2
	5	□	MMS1360L-DIN-C	57.1	77.5	78.5	124.5	122	2.5	14	1
	3	★	MMS1360X3DB	43.3	72.5	72.5	128.5	126	2.5	14	1
	5	★	MMS1360X5DB	70.5	100.5	100.5	156.5	154	2.5	14	1
13.7	3	□	MMS1370S-DIN	39.9	60.5	61.5	107.5	105	2.5	14	2
	3	●	MMS1370S-DIN-C	39.9	60.5	61.5	107.5	105	2.5	14	1
	5	□	MMS1370L-DIN	56.9	77.5	78.5	124.5	122	2.5	14	2
	5	●	MMS1370L-DIN-C	56.9	77.5	78.5	124.5	122	2.5	14	1
	3	★	MMS1370X3DB	43.6	72.5	72.5	128.5	126	2.5	14	1
	5	★	MMS1370X5DB	71.0	100.5	100.5	156.5	154	2.5	14	1
13.8	3	□	MMS1380S-DIN	39.8	60.5	61.5	107.5	105	2.5	14	2
	3	□	MMS1380S-DIN-C	39.8	60.5	61.5	107.5	105	2.5	14	1
	5	□	MMS1380L-DIN	56.8	77.5	78.5	124.5	122	2.5	14	2
	5	□	MMS1380L-DIN-C	56.8	77.5	78.5	124.5	122	2.5	14	1
	3	★	MMS1380X3DB	43.9	72.5	72.5	128.5	126	2.5	14	1
	5	★	MMS1380X5DB	71.5	100.5	100.5	156.5	154	2.5	14	1
13.9	3	□	MMS1390S-DIN	39.7	60.5	61.5	107.5	105	2.5	14	2
	3	□	MMS1390S-DIN-C	39.7	60.5	61.5	107.5	105	2.5	14	1
	5	□	MMS1390L-DIN	56.7	77.5	78.5	124.5	122	2.5	14	2
	5	□	MMS1390L-DIN-C	56.7	77.5	78.5	124.5	122	2.5	14	1
	3	★	MMS1390X3DB	44.2	72.5	72.5	128.5	126	2.5	14	1
	5	★	MMS1390X5DB	72.0	100.5	100.5	156.5	154	2.5	14	1

DC	Bohrtiefe (mm)	DP7020 (L/D)	Bestellnummer	Abmessungen (mm)							Typ
				LU	LCF	LH	OAL	LF	PL	DCONMS	
14.0	3	□	MMS1400S-DIN	39.5	60.5	61.5	107.5	105	2.5	14	2
	3	●	MMS1400S-DIN-C	39.5	60.5	61.5	107.5	105	2.5	14	1
	5	□	MMS1400L-DIN	56.5	77.5	78.5	124.5	122	2.5	14	2
	5	●	MMS1400L-DIN-C	56.5	77.5	78.5	124.5	122	2.5	14	1
	3	★	MMS1400X3DB	44.5	72.5	72.5	128.5	126	2.5	14	1
	5	★	MMS1400X5DB	72.5	100.5	100.5	156.5	154	2.5	14	1
14.05	3	□	MMS1405S-DIN	43.5	64.6	65.6	114.6	112	2.6	16	2
	3	□	MMS1405S-DIN-C	43.5	64.6	65.6	114.6	112	2.6	16	1
	5	□	MMS1405L-DIN	61.5	82.6	83.6	132.6	130	2.6	16	2
	5	□	MMS1405L-DIN-C	61.5	82.6	83.6	132.6	130	2.6	16	1
14.1	3	□	MMS1410S-DIN	43.4	64.6	65.6	114.6	112	2.6	16	2
	3	□	MMS1410S-DIN-C	43.4	64.6	65.6	114.6	112	2.6	16	1
	5	□	MMS1410L-DIN	61.4	82.6	83.6	132.6	130	2.6	16	2
	5	□	MMS1410L-DIN-C	61.4	82.6	83.6	132.6	130	2.6	16	1
	3	★	MMS1410X3DB	44.9	75.6	78.6	137.6	135	2.6	16	1
5	★	MMS1410X5DB	73.1	104.6	108.6	167.6	165	2.6	16	1	
14.2	3	□	MMS1420S-DIN	43.3	64.6	65.6	114.6	112	2.6	16	2
	3	□	MMS1420S-DIN-C	43.3	64.6	65.6	114.6	112	2.6	16	1
	5	□	MMS1420L-DIN	61.3	82.6	83.6	132.6	130	2.6	16	2
	5	□	MMS1420L-DIN-C	61.3	82.6	83.6	132.6	130	2.6	16	1
	3	★	MMS1420X3DB	45.2	75.6	78.6	137.6	135	2.6	16	1
5	★	MMS1420X5DB	73.6	104.6	108.6	167.6	165	2.6	16	1	
14.3	3	□	MMS1430S-DIN	43.2	64.6	65.6	114.6	112	2.6	16	2
	3	□	MMS1430S-DIN-C	43.2	64.6	65.6	114.6	112	2.6	16	1
	5	□	MMS1430L-DIN	61.2	82.6	83.6	132.6	130	2.6	16	2
	5	□	MMS1430L-DIN-C	61.2	82.6	83.6	132.6	130	2.6	16	1
	3	★	MMS1430X3DB	45.5	75.6	78.6	137.6	135	2.6	16	1
5	★	MMS1430X5DB	74.1	104.6	108.6	167.6	165	2.6	16	1	
14.4	3	□	MMS1440S-DIN	43.0	64.6	65.6	114.6	112	2.6	16	2
	3	□	MMS1440S-DIN-C	43.0	64.6	65.6	114.6	112	2.6	16	1
	5	□	MMS1440L-DIN	61.0	82.6	83.6	132.6	130	2.6	16	2
	5	□	MMS1440L-DIN-C	61.0	82.6	83.6	132.6	130	2.6	16	1
	3	★	MMS1440X3DB	45.8	75.6	78.6	137.6	135	2.6	16	1
5	★	MMS1440X5DB	74.6	104.6	108.6	167.6	165	2.6	16	1	
14.5	3	□	MMS1450S-DIN	42.9	64.6	65.6	114.6	112	2.6	16	2
	3	□	MMS1450S-DIN-C	42.9	64.6	65.6	114.6	112	2.6	16	1
	5	□	MMS1450L-DIN	60.9	82.6	83.6	132.6	130	2.6	16	2
	5	□	MMS1450L-DIN-C	60.9	82.6	83.6	132.6	130	2.6	16	1
	3	★	MMS1450X3DB	46.1	75.6	78.6	137.6	135	2.6	16	1
5	★	MMS1450X5DB	75.1	104.6	108.6	167.6	165	2.6	16	1	
14.6	3	□	MMS1460S-DIN	42.8	64.7	65.7	114.7	112	2.7	16	2
	3	□	MMS1460S-DIN-C	42.8	64.7	65.7	114.7	112	2.7	16	1
	5	□	MMS1460L-DIN	60.8	82.7	83.7	132.7	130	2.7	16	2
	5	□	MMS1460L-DIN-C	60.8	82.7	83.7	132.7	130	2.7	16	1
	3	★	MMS1460X3DB	46.5	77.7	78.7	137.7	135	2.7	16	1
5	★	MMS1460X5DB	75.7	107.7	108.7	167.7	165	2.7	16	1	
14.7	3	□	MMS1470S-DIN	42.6	64.7	65.7	114.7	112	2.7	16	2
	3	□	MMS1470S-DIN-C	42.6	64.7	65.7	114.7	112	2.7	16	1
	5	□	MMS1470L-DIN	60.6	82.7	83.7	132.7	130	2.7	16	2
	5	□	MMS1470L-DIN-C	60.6	82.7	83.7	132.7	130	2.7	16	1
	3	★	MMS1470X3DB	46.8	77.7	78.7	137.7	135	2.7	16	1
5	★	MMS1470X5DB	76.2	107.7	108.7	167.7	165	2.7	16	1	

M

BOHREN

# MMS

M

BOHREN

DC	Bohrtiefe (mm)	DP7020 (L/D)	Bestellnummer	Abmessungen (mm)							Typ
				LU	LCF	LH	OAL	LF	PL	DCONMS	
14.8	3	<input type="checkbox"/>	MMS1480S-DIN	42.5	64.7	65.7	114.7	112	2.7	16	2
	3	<input type="checkbox"/>	MMS1480S-DIN-C	42.5	64.7	65.7	114.7	112	2.7	16	1
	5	<input type="checkbox"/>	MMS1480L-DIN	60.5	82.7	83.7	132.7	130	2.7	16	2
	5	<input type="checkbox"/>	MMS1480L-DIN-C	60.5	82.7	83.7	132.7	130	2.7	16	1
	3	<input checked="" type="checkbox"/>	MMS1480X3DB	47.1	77.7	78.7	137.7	135	2.7	16	1
	5	<input checked="" type="checkbox"/>	MMS1480X5DB	76.7	107.7	108.7	167.7	165	2.7	16	1
14.9	3	<input type="checkbox"/>	MMS1490S-DIN	42.4	64.7	65.7	114.7	112	2.7	16	2
	3	<input type="checkbox"/>	MMS1490S-DIN-C	42.4	64.7	65.7	114.7	112	2.7	16	1
	5	<input type="checkbox"/>	MMS1490L-DIN	60.4	82.7	83.7	132.7	130	2.7	16	2
	5	<input type="checkbox"/>	MMS1490L-DIN-C	60.4	82.7	83.7	132.7	130	2.7	16	1
	3	<input checked="" type="checkbox"/>	MMS1490X3DB	47.4	77.7	78.7	137.7	135	2.7	16	1
	5	<input checked="" type="checkbox"/>	MMS1490X5DB	77.2	107.7	108.7	167.7	165	2.7	16	1
15.0	3	<input type="checkbox"/>	MMS1500S-DIN	42.2	64.7	65.7	114.7	112	2.7	16	2
	3	<input type="checkbox"/>	MMS1500S-DIN-C	42.2	64.7	65.7	114.7	112	2.7	16	1
	5	<input type="checkbox"/>	MMS1500L-DIN	60.2	82.7	83.7	132.7	130	2.7	16	2
	5	<input type="checkbox"/>	MMS1500L-DIN-C	60.2	82.7	83.7	132.7	130	2.7	16	1
	3	<input checked="" type="checkbox"/>	MMS1500X3DB	47.7	77.7	78.7	137.7	135	2.7	16	1
	5	<input checked="" type="checkbox"/>	MMS1500X5DB	77.7	107.7	108.7	167.7	165	2.7	16	1
15.1	3	<input type="checkbox"/>	MMS1510S-DIN	42.1	64.7	65.7	114.7	112	2.7	16	2
	3	<input type="checkbox"/>	MMS1510S-DIN-C	42.1	64.7	65.7	114.7	112	2.7	16	1
	5	<input type="checkbox"/>	MMS1510L-DIN	60.1	82.7	83.7	132.7	130	2.7	16	2
	5	<input type="checkbox"/>	MMS1510L-DIN-C	60.1	82.7	83.7	132.7	130	2.7	16	1
	3	<input checked="" type="checkbox"/>	MMS1510X3DB	48.0	80.7	82.7	141.7	139	2.7	16	1
	5	<input checked="" type="checkbox"/>	MMS1510X5DB	78.2	111.7	114.7	173.7	171	2.7	16	1
15.2	3	<input type="checkbox"/>	MMS1520S-DIN	42.0	64.8	65.8	114.8	112	2.8	16	2
	3	<input type="checkbox"/>	MMS1520S-DIN-C	42.0	64.8	65.8	114.8	112	2.8	16	1
	5	<input type="checkbox"/>	MMS1520L-DIN	60.0	82.8	83.8	132.8	130	2.8	16	2
	5	<input type="checkbox"/>	MMS1520L-DIN-C	60.0	82.8	83.8	132.8	130	2.8	16	1
	3	<input checked="" type="checkbox"/>	MMS1520X3DB	48.4	80.8	82.8	141.8	139	2.8	16	1
	5	<input checked="" type="checkbox"/>	MMS1520X5DB	78.8	111.8	114.8	173.8	171	2.8	16	1
15.3	3	<input type="checkbox"/>	MMS1530S-DIN	41.8	64.8	65.8	114.8	112	2.8	16	2
	3	<input type="checkbox"/>	MMS1530S-DIN-C	41.8	64.8	65.8	114.8	112	2.8	16	1
	5	<input type="checkbox"/>	MMS1530L-DIN	59.8	82.8	83.8	132.8	130	2.8	16	2
	5	<input type="checkbox"/>	MMS1530L-DIN-C	59.8	82.8	83.8	132.8	130	2.8	16	1
	3	<input checked="" type="checkbox"/>	MMS1530X3DB	48.7	80.8	82.8	141.8	139	2.8	16	1
	5	<input checked="" type="checkbox"/>	MMS1530X5DB	79.3	111.8	114.8	173.8	171	2.8	16	1
15.4	3	<input type="checkbox"/>	MMS1540S-DIN	41.7	64.8	65.8	114.8	112	2.8	16	2
	3	<input type="checkbox"/>	MMS1540S-DIN-C	41.7	64.8	65.8	114.8	112	2.8	16	1
	5	<input type="checkbox"/>	MMS1540L-DIN	59.7	82.8	83.8	132.8	130	2.8	16	2
	5	<input type="checkbox"/>	MMS1540L-DIN-C	59.7	82.8	83.8	132.8	130	2.8	16	1
	3	<input checked="" type="checkbox"/>	MMS1540X3DB	49.0	80.8	82.8	141.8	139	2.8	16	1
	5	<input checked="" type="checkbox"/>	MMS1540X5DB	79.8	111.8	114.8	173.8	171	2.8	16	1
15.5	3	<input type="checkbox"/>	MMS1550S-DIN	41.6	64.8	65.8	114.8	112	2.8	16	2
	3	<input type="checkbox"/>	MMS1550S-DIN-C	41.6	64.8	65.8	114.8	112	2.8	16	1
	5	<input type="checkbox"/>	MMS1550L-DIN	59.6	82.8	83.8	132.8	130	2.8	16	2
	5	<input type="checkbox"/>	MMS1550L-DIN-C	59.6	82.8	83.8	132.8	130	2.8	16	1
	3	<input checked="" type="checkbox"/>	MMS1550X3DB	49.3	80.8	82.8	141.8	139	2.8	16	1
	5	<input checked="" type="checkbox"/>	MMS1550X5DB	80.3	111.8	114.8	173.8	171	2.8	16	1

DC	Bohrtiefe (mm)	DP7020 (L/D)	Bestellnummer	Abmessungen (mm)							Typ
				LU	LCF	LH	OAL	LF	PL	DCONMS	
15.6	3	<input type="checkbox"/>	MMS1560S-DIN	41.4	64.8	65.8	114.8	112	2.8	16	2
	3	<input type="checkbox"/>	MMS1560S-DIN-C	41.4	64.8	65.8	114.8	112	2.8	16	1
	5	<input type="checkbox"/>	MMS1560L-DIN	59.4	82.8	83.8	132.8	130	2.8	16	2
	5	<input type="checkbox"/>	MMS1560L-DIN-C	59.4	82.8	83.8	132.8	130	2.8	16	1
	3	<input checked="" type="checkbox"/>	MMS1560X3DB	49.6	82.8	82.8	141.8	139	2.8	16	1
	5	<input checked="" type="checkbox"/>	MMS1560X5DB	80.8	114.8	114.8	173.8	171	2.8	16	1
15.7	3	<input type="checkbox"/>	MMS1570S-DIN	41.3	64.9	65.9	114.9	112	2.9	16	2
	3	<input type="checkbox"/>	MMS1570S-DIN-C	41.3	64.9	65.9	114.9	112	2.9	16	1
	5	<input type="checkbox"/>	MMS1570L-DIN	59.3	82.9	83.9	132.9	130	2.9	16	2
	5	<input type="checkbox"/>	MMS1570L-DIN-C	59.3	82.9	83.9	132.9	130	2.9	16	1
	3	<input checked="" type="checkbox"/>	MMS1570X3DB	50.0	82.9	82.9	141.9	139	2.9	16	1
	5	<input checked="" type="checkbox"/>	MMS1570X5DB	81.4	114.9	114.9	173.9	171	2.9	16	1
15.8	3	<input type="checkbox"/>	MMS1580S-DIN	41.2	64.9	65.9	114.9	112	2.9	16	2
	3	<input type="checkbox"/>	MMS1580S-DIN-C	41.2	64.9	65.9	114.9	112	2.9	16	1
	5	<input type="checkbox"/>	MMS1580L-DIN	59.2	82.9	83.9	132.9	130	2.9	16	2
	5	<input type="checkbox"/>	MMS1580L-DIN-C	59.2	82.9	83.9	132.9	130	2.9	16	1
	3	<input checked="" type="checkbox"/>	MMS1580X3DB	50.3	82.9	82.9	141.9	139	2.9	16	1
	5	<input checked="" type="checkbox"/>	MMS1580X5DB	81.9	114.9	114.9	173.9	171	2.9	16	1
15.9	3	<input type="checkbox"/>	MMS1590S-DIN	41.0	64.9	65.9	114.9	112	2.9	16	2
	3	<input type="checkbox"/>	MMS1590S-DIN-C	41.0	64.9	65.9	114.9	112	2.9	16	1
	5	<input type="checkbox"/>	MMS1590L-DIN	59.0	82.9	83.9	132.9	130	2.9	16	2
	5	<input type="checkbox"/>	MMS1590L-DIN-C	59.0	82.9	83.9	132.9	130	2.9	16	1
	3	<input checked="" type="checkbox"/>	MMS1590X3DB	50.6	82.9	82.9	141.9	139	2.9	16	1
	5	<input checked="" type="checkbox"/>	MMS1590X5DB	82.4	114.9	114.9	173.9	171	2.9	16	1
16.0	3	<input type="checkbox"/>	MMS1600S-DIN	40.9	64.9	65.9	114.9	112	2.9	16	2
	3	<input type="checkbox"/>	MMS1600S-DIN-C	40.9	64.9	65.9	114.9	112	2.9	16	1
	5	<input type="checkbox"/>	MMS1600L-DIN	58.9	82.9	83.9	132.9	130	2.9	16	2
	5	<input type="checkbox"/>	MMS1600L-DIN-C	58.9	82.9	83.9	132.9	130	2.9	16	1
	3	<input checked="" type="checkbox"/>	MMS1600X3DB	50.9	82.9	82.9	141.9	139	2.9	16	1
	5	<input checked="" type="checkbox"/>	MMS1600X5DB	82.9	114.9	114.9	173.9	171	2.9	16	1
16.1	3	<input type="checkbox"/>	MMS1610S-DIN	48.8	72.9	73.9	122.9	120	2.9	18	2
	3	<input type="checkbox"/>	MMS1610S-DIN-C	48.8	72.9	73.9	122.9	120	2.9	18	1
	5	<input type="checkbox"/>	MMS1610L-DIN	68.8	92.9	93.9	142.9	140	2.9	18	2
	5	<input type="checkbox"/>	MMS1610L-DIN-C	68.8	92.9	93.9	142.9	140	2.9	18	1
	3	<input type="checkbox"/>	MMS1610X3DB	51.2	85.9	88.9	147.9	145	2.9	18	1
	5	<input type="checkbox"/>	MMS1610X5DB	83.4	118.9	122.9	181.9	179	2.9	18	1
16.2	3	<input type="checkbox"/>	MMS1620S-DIN	48.6	72.9	73.9	122.9	120	2.9	18	2
	3	<input type="checkbox"/>	MMS1620S-DIN-C	48.6	72.9	73.9	122.9	120	2.9	18	1
	5	<input type="checkbox"/>	MMS1620L-DIN	68.6	92.9	93.9	142.9	140	2.9	18	2
	5	<input type="checkbox"/>	MMS1620L-DIN-C	68.6	92.9	93.9	142.9	140	2.9	18	1
	3	<input type="checkbox"/>	MMS1620X3DB	51.5	85.9	88.9	147.9	145	2.9	18	1
	5	<input type="checkbox"/>	MMS1620X5DB	83.9	118.9	122.9	181.9	179	2.9	18	1
16.3	3	<input type="checkbox"/>	MMS1630S-DIN	48.5	73.0	74.0	123.0	120	3.0	18	2
	3	<input type="checkbox"/>	MMS1630S-DIN-C	48.5	73.0	74.0	123.0	120	3.0	18	1
	5	<input type="checkbox"/>	MMS1630L-DIN	68.5	93.0	94.0	143.0	140	3.0	18	2
	5	<input type="checkbox"/>	MMS1630L-DIN-C	68.5	93.0	94.0	143.0	140	3.0	18	1
	3	<input type="checkbox"/>	MMS1630X3DB	51.9	86.0	89.0	148.0	145	3.0	18	1
	5	<input type="checkbox"/>	MMS1630X5DB	84.5	119.0	123.0	182.0	179	3.0	18	1

★ : Lagerstandard in Japan. □ : Herstellung nur auf Anfrage

DC	Bohrtiefe (mm)	DP7020 (L/D)	Bestellnummer	Abmessungen (mm)							Typ
				LU	LCF	LH	OAL	LF	PL	DCONMS	
16.4	3	□	MMS1640S-DIN	48.4	73.0	74.0	123.0	120	3.0	18	2
	3	□	MMS1640S-DIN-C	48.4	73.0	74.0	123.0	120	3.0	18	1
	5	□	MMS1640L-DIN	68.4	93.0	94.0	143.0	140	3.0	18	2
	5	□	MMS1640L-DIN-C	68.4	93.0	94.0	143.0	140	3.0	18	1
	3	□	MMS1640X3DB	52.2	86.0	89.0	148.0	145	3.0	18	1
	5	□	MMS1640X5DB	85.0	119.0	123.0	182.0	179	3.0	18	1
16.5	3	□	MMS1650S-DIN	48.3	73.0	74.0	123.0	120	3.0	18	2
	3	□	MMS1650S-DIN-C	48.3	73.0	74.0	123.0	120	3.0	18	1
	5	□	MMS1650L-DIN	68.3	93.0	94.0	143.0	140	3.0	18	2
	5	□	MMS1650L-DIN-C	68.3	93.0	94.0	143.0	140	3.0	18	1
	3	★	MMS1650X3DB	52.5	86.0	89.0	148.0	145	3.0	18	1
	5	★	MMS1650X5DB	85.5	119.0	123.0	182.0	179	3.0	18	1
16.6	3	□	MMS1660S-DIN	48.1	73.0	74.0	123.0	120	3.0	18	2
	3	□	MMS1660S-DIN-C	48.1	73.0	74.0	123.0	120	3.0	18	1
	5	□	MMS1660L-DIN	68.1	93.0	94.0	143.0	140	3.0	18	2
	5	□	MMS1660L-DIN-C	68.1	93.0	94.0	143.0	140	3.0	18	1
	3	□	MMS1660X3DB	52.8	88.0	89.0	148.0	145	3.0	18	1
	5	□	MMS1660X5DB	86.0	122.0	123.0	182.0	179	3.0	18	1
16.7	3	□	MMS1670S-DIN	48.0	73.0	74.0	123.0	120	3.0	18	2
	3	□	MMS1670S-DIN-C	48.0	73.0	74.0	123.0	120	3.0	18	1
	5	□	MMS1670L-DIN	68.0	93.0	94.0	143.0	140	3.0	18	2
	5	□	MMS1670L-DIN-C	68.0	93.0	94.0	143.0	140	3.0	18	1
	3	□	MMS1670X3DB	53.1	88.0	89.0	148.0	145	3.0	18	1
	5	□	MMS1670X5DB	86.5	122.0	123.0	182.0	179	3.0	18	1
16.8	3	□	MMS1680S-DIN	47.9	73.1	74.1	123.1	120	3.1	18	2
	3	□	MMS1680S-DIN-C	47.9	73.1	74.1	123.1	120	3.1	18	1
	5	□	MMS1680L-DIN	67.9	93.1	94.1	143.1	140	3.1	18	2
	5	□	MMS1680L-DIN-C	67.9	93.1	94.1	143.1	140	3.1	18	1
	3	□	MMS1680X3DB	53.5	88.1	89.1	148.1	145	3.1	18	1
	5	□	MMS1680X5DB	87.1	122.1	123.1	182.1	179	3.1	18	1
16.9	3	□	MMS1690S-DIN	47.7	73.1	74.1	123.1	120	3.1	18	2
	3	□	MMS1690S-DIN-C	47.7	73.1	74.1	123.1	120	3.1	18	1
	5	□	MMS1690L-DIN	67.7	93.1	94.1	143.1	140	3.1	18	2
	5	□	MMS1690L-DIN-C	67.7	93.1	94.1	143.1	140	3.1	18	1
	3	□	MMS1690X3DB	53.8	88.1	89.1	148.1	145	3.1	18	1
	5	□	MMS1690X5DB	87.6	122.1	123.1	182.1	179	3.1	18	1
17.0	3	□	MMS1700S-DIN	47.6	73.1	74.1	123.1	120	3.1	18	2
	3	□	MMS1700S-DIN-C	47.6	73.1	74.1	123.1	120	3.1	18	1
	5	□	MMS1700L-DIN	67.6	93.1	94.1	143.1	140	3.1	18	2
	5	□	MMS1700L-DIN-C	67.6	93.1	94.1	143.1	140	3.1	18	1
	3	★	MMS1700X3DB	54.1	88.1	89.1	148.1	145	3.1	18	1
	5	★	MMS1700X5DB	88.1	122.1	123.1	182.1	179	3.1	18	1
17.1	3	□	MMS1710S-DIN	47.5	73.1	74.1	123.1	120	3.1	18	2
	3	□	MMS1710S-DIN-C	47.5	73.1	74.1	123.1	120	3.1	18	1
	5	□	MMS1710L-DIN	67.5	93.1	94.1	143.1	140	3.1	18	2
	5	□	MMS1710L-DIN-C	67.5	93.1	94.1	143.1	140	3.1	18	1
	3	□	MMS1710X3DB	54.4	91.1	93.1	152.1	149	3.1	18	1
	5	□	MMS1710X5DB	88.6	126.1	129.1	188.1	185	3.1	18	1

DC	Bohrtiefe (mm)	DP7020 (L/D)	Bestellnummer	Abmessungen (mm)							Typ
				LU	LCF	LH	OAL	LF	PL	DCONMS	
17.2	3	□	MMS1720S-DIN	47.3	73.1	74.1	123.1	120	3.1	18	2
	3	□	MMS1720S-DIN-C	47.3	73.1	74.1	123.1	120	3.1	18	1
	5	□	MMS1720L-DIN	67.3	93.1	94.1	143.1	140	3.1	18	2
	5	□	MMS1720L-DIN-C	67.3	93.1	94.1	143.1	140	3.1	18	1
	3	□	MMS1720X3DB	54.7	91.1	93.1	152.1	149	3.1	18	1
	5	□	MMS1720X5DB	89.1	126.1	129.1	188.1	185	3.1	18	1
17.3	3	□	MMS1730S-DIN	47.2	73.1	74.1	123.1	120	3.1	18	2
	3	□	MMS1730S-DIN-C	47.2	73.1	74.1	123.1	120	3.1	18	1
	5	□	MMS1730L-DIN	67.2	93.1	94.1	143.1	140	3.1	18	2
	5	□	MMS1730L-DIN-C	67.2	93.1	94.1	143.1	140	3.1	18	1
	3	□	MMS1730X3DB	55.0	91.1	93.1	152.1	149	3.1	18	1
	5	□	MMS1730X5DB	89.6	126.1	129.1	188.1	185	3.1	18	1
17.4	3	□	MMS1740S-DIN	47.1	73.2	74.2	123.2	120	3.2	18	2
	3	□	MMS1740S-DIN-C	47.1	73.2	74.2	123.2	120	3.2	18	1
	5	□	MMS1740L-DIN	67.1	93.2	94.2	143.2	140	3.2	18	2
	5	□	MMS1740L-DIN-C	67.1	93.2	94.2	143.2	140	3.2	18	1
	3	□	MMS1740X3DB	55.4	91.2	93.2	152.2	149	3.2	18	1
	5	□	MMS1740X5DB	90.2	126.2	129.2	188.2	185	3.2	18	1
17.5	3	□	MMS1750S-DIN	46.9	73.2	74.2	123.2	120	3.2	18	2
	3	□	MMS1750S-DIN-C	46.9	73.2	74.2	123.2	120	3.2	18	1
	5	□	MMS1750L-DIN	66.9	93.2	94.2	143.2	140	3.2	18	2
	5	□	MMS1750L-DIN-C	66.9	93.2	94.2	143.2	140	3.2	18	1
	3	★	MMS1750X3DB	55.7	91.2	93.2	152.2	149	3.2	18	1
	5	★	MMS1750X5DB	90.7	126.2	129.2	188.2	185	3.2	18	1
17.6	3	□	MMS1760S-DIN	46.8	73.2	74.2	123.2	120	3.2	18	2
	3	□	MMS1760S-DIN-C	46.8	73.2	74.2	123.2	120	3.2	18	1
	5	□	MMS1760L-DIN	66.8	93.2	94.2	143.2	140	3.2	18	2
	5	□	MMS1760L-DIN-C	66.8	93.2	94.2	143.2	140	3.2	18	1
	3	□	MMS1760X3DB	56.0	93.2	93.2	152.2	149	3.2	18	1
	5	□	MMS1760X5DB	91.2	129.2	129.2	188.2	185	3.2	18	1
17.7	3	□	MMS1770S-DIN	46.7	73.2	74.2	123.2	120	3.2	18	2
	3	□	MMS1770S-DIN-C	46.7	73.2	74.2	123.2	120	3.2	18	1
	5	□	MMS1770L-DIN	66.7	93.2	94.2	143.2	140	3.2	18	2
	5	□	MMS1770L-DIN-C	66.7	93.2	94.2	143.2	140	3.2	18	1
	3	□	MMS1770X3DB	56.3	93.2	93.2	152.2	149	3.2	18	1
	5	□	MMS1770X5DB	91.7	129.2	129.2	188.2	185	3.2	18	1
17.8	3	□	MMS1780S-DIN	46.5	73.2	74.2	123.2	120	3.2	18	2
	3	□	MMS1780S-DIN-C	46.5	73.2	74.2	123.2	120	3.2	18	1
	5	□	MMS1780L-DIN	66.5	93.2	94.2	143.2	140	3.2	18	2
	5	□	MMS1780L-DIN-C	66.5	93.2	94.2	143.2	140	3.2	18	1
	3	□	MMS1780X3DB	56.6	93.2	93.2	152.2	149	3.2	18	1
	5	□	MMS1780X5DB	92.2	129.2	129.2	188.2	185	3.2	18	1
17.9	3	□	MMS1790S-DIN	46.4	73.3	74.3	123.3	120	3.3	18	2
	3	□	MMS1790S-DIN-C	46.4	73.3	74.3	123.3	120	3.3	18	1
	5	□	MMS1790L-DIN	66.4	93.3	94.3	143.3	140	3.3	18	2
	5	□	MMS1790L-DIN-C	66.4	93.3	94.3	143.3	140	3.3	18	1
	3	□	MMS1790X3DB	57.0	93.3	93.3	152.3	149	3.3	18	1
	5	□	MMS1790X5DB	92.8	129.3	129.3	188.3	185	3.3	18	1

M

BOHREN

# MMS

M

BOHREN

DC	Bohrtiefe (mm)	DP7020 (L/D)	Bestellnummer	Abmessungen (mm)							Typ
				LU	LCF	LH	OAL	LF	PL	DCONMS	
18.0	3	<input type="checkbox"/>	MMS1800S-DIN	46.3	73.3	74.3	123.3	120	3.3	18	2
	3	<input type="checkbox"/>	MMS1800S-DIN-C	46.3	73.3	74.3	123.3	120	3.3	18	1
	5	<input type="checkbox"/>	MMS1800L-DIN	66.3	93.3	94.3	143.3	140	3.3	18	2
	5	<input type="checkbox"/>	MMS1800L-DIN-C	66.3	93.3	94.3	143.3	140	3.3	18	1
	3	<input checked="" type="checkbox"/>	MMS1800X3DB	57.3	93.3	93.3	152.3	149	3.3	18	1
	5	<input checked="" type="checkbox"/>	MMS1800X5DB	93.3	129.3	129.3	188.3	185	3.3	18	1
18.1	3	<input type="checkbox"/>	MMS1810S-DIN	52.1	79.3	80.3	131.3	128	3.3	20	2
	3	<input type="checkbox"/>	MMS1810S-DIN-C	52.1	79.3	80.3	131.3	128	3.3	20	1
	5	<input type="checkbox"/>	MMS1810L-DIN	74.1	101.3	102.3	153.3	150	3.3	20	2
	5	<input type="checkbox"/>	MMS1810L-DIN-C	74.1	101.3	102.3	153.3	150	3.3	20	1
	3	<input type="checkbox"/>	MMS1810X3DB	57.6	96.3	99.3	160.3	157	3.3	20	1
	5	<input type="checkbox"/>	MMS1810X5DB	93.8	133.3	137.3	198.3	195	3.3	20	1
18.2	3	<input type="checkbox"/>	MMS1820S-DIN	52.0	79.3	80.3	131.3	128	3.3	20	2
	3	<input type="checkbox"/>	MMS1820S-DIN-C	52.0	79.3	80.3	131.3	128	3.3	20	1
	5	<input type="checkbox"/>	MMS1820L-DIN	74.0	101.3	102.3	153.3	150	3.3	20	2
	5	<input type="checkbox"/>	MMS1820L-DIN-C	74.0	101.3	102.3	153.3	150	3.3	20	1
	3	<input type="checkbox"/>	MMS1820X3DB	57.9	96.3	99.3	160.3	157	3.3	20	1
	5	<input type="checkbox"/>	MMS1820X5DB	94.3	133.3	137.3	198.3	195	3.3	20	1
18.3	3	<input type="checkbox"/>	MMS1830S-DIN	51.9	79.3	80.3	131.3	128	3.3	20	2
	3	<input type="checkbox"/>	MMS1830S-DIN-C	51.9	79.3	80.3	131.3	128	3.3	20	1
	5	<input type="checkbox"/>	MMS1830L-DIN	73.9	101.3	102.3	153.3	150	3.3	20	2
	5	<input type="checkbox"/>	MMS1830L-DIN-C	73.9	101.3	102.3	153.3	150	3.3	20	1
	3	<input type="checkbox"/>	MMS1830X3DB	58.2	96.3	99.3	160.3	157	3.3	20	1
	5	<input type="checkbox"/>	MMS1830X5DB	94.8	133.3	137.3	198.3	195	3.3	20	1
18.4	3	<input type="checkbox"/>	MMS1840S-DIN	51.7	79.3	80.3	131.3	128	3.3	20	2
	3	<input type="checkbox"/>	MMS1840S-DIN-C	51.7	79.3	80.3	131.3	128	3.3	20	1
	5	<input type="checkbox"/>	MMS1840L-DIN	73.7	101.3	102.3	153.3	150	3.3	20	2
	5	<input type="checkbox"/>	MMS1840L-DIN-C	73.7	101.3	102.3	153.3	150	3.3	20	1
	3	<input type="checkbox"/>	MMS1840X3DB	58.5	96.3	99.3	160.3	157	3.3	20	1
	5	<input type="checkbox"/>	MMS1840X5DB	95.3	133.3	137.3	198.3	195	3.3	20	1
18.5	3	<input type="checkbox"/>	MMS1850S-DIN	51.6	79.4	80.4	131.4	128	3.4	20	2
	3	<input type="checkbox"/>	MMS1850S-DIN-C	51.6	79.4	80.4	131.4	128	3.4	20	1
	5	<input type="checkbox"/>	MMS1850L-DIN	73.6	101.4	102.4	153.4	150	3.4	20	2
	5	<input type="checkbox"/>	MMS1850L-DIN-C	73.6	101.4	102.4	153.4	150	3.4	20	1
	3	<input checked="" type="checkbox"/>	MMS1850X3DB	58.9	96.4	99.4	160.4	157	3.4	20	1
	5	<input checked="" type="checkbox"/>	MMS1850X5DB	95.9	133.4	137.4	198.4	195	3.4	20	1
18.6	3	<input type="checkbox"/>	MMS1860S-DIN	51.5	79.4	80.4	131.4	128	3.4	20	2
	3	<input type="checkbox"/>	MMS1860S-DIN-C	51.5	79.4	80.4	131.4	128	3.4	20	1
	5	<input type="checkbox"/>	MMS1860L-DIN	73.5	101.4	102.4	153.4	150	3.4	20	2
	5	<input type="checkbox"/>	MMS1860L-DIN-C	73.5	101.4	102.4	153.4	150	3.4	20	1
	3	<input type="checkbox"/>	MMS1860X3DB	59.2	98.4	99.4	160.4	157	3.4	20	1
	5	<input type="checkbox"/>	MMS1860X5DB	96.4	136.4	137.4	198.4	195	3.4	20	1
18.7	3	<input type="checkbox"/>	MMS1870S-DIN	51.4	79.4	80.4	131.4	128	3.4	20	2
	3	<input type="checkbox"/>	MMS1870S-DIN-C	51.4	79.4	80.4	131.4	128	3.4	20	1
	5	<input type="checkbox"/>	MMS1870L-DIN	73.4	101.4	102.4	153.4	150	3.4	20	2
	5	<input type="checkbox"/>	MMS1870L-DIN-C	73.4	101.4	102.4	153.4	150	3.4	20	1
	3	<input type="checkbox"/>	MMS1870X3DB	59.5	98.4	99.4	160.4	157	3.4	20	1
	5	<input type="checkbox"/>	MMS1870X5DB	96.9	136.4	137.4	198.4	195	3.4	20	1

DC	Bohrtiefe (mm)	DP7020 (L/D)	Bestellnummer	Abmessungen (mm)							Typ
				LU	LCF	LH	OAL	LF	PL	DCONMS	
18.8	3	<input type="checkbox"/>	MMS1880S-DIN	51.2	79.4	80.4	131.4	128	3.4	20	2
	3	<input type="checkbox"/>	MMS1880S-DIN-C	51.2	79.4	80.4	131.4	128	3.4	20	1
	5	<input type="checkbox"/>	MMS1880L-DIN	73.2	101.4	102.4	153.4	150	3.4	20	2
	5	<input type="checkbox"/>	MMS1880L-DIN-C	73.2	101.4	102.4	153.4	150	3.4	20	1
	3	<input type="checkbox"/>	MMS1880X3DB	59.8	98.4	99.4	160.4	157	3.4	20	1
	5	<input type="checkbox"/>	MMS1880X5DB	97.4	136.4	137.4	198.4	195	3.4	20	1
18.9	3	<input type="checkbox"/>	MMS1890S-DIN	51.1	79.4	80.4	131.4	128	3.4	20	2
	3	<input type="checkbox"/>	MMS1890S-DIN-C	51.1	79.4	80.4	131.4	128	3.4	20	1
	5	<input type="checkbox"/>	MMS1890L-DIN	73.1	101.4	102.4	153.4	150	3.4	20	2
	5	<input type="checkbox"/>	MMS1890L-DIN-C	73.1	101.4	102.4	153.4	150	3.4	20	1
	3	<input type="checkbox"/>	MMS1890X3DB	60.1	98.4	99.4	160.4	157	3.4	20	1
	5	<input type="checkbox"/>	MMS1890X5DB	97.9	136.4	137.4	198.4	195	3.4	20	1
19.0	3	<input type="checkbox"/>	MMS1900S-DIN	51.0	79.5	80.5	131.5	128	3.5	20	2
	3	<input type="checkbox"/>	MMS1900S-DIN-C	51.0	79.5	80.5	131.5	128	3.5	20	1
	5	<input type="checkbox"/>	MMS1900L-DIN	73.0	101.5	102.5	153.5	150	3.5	20	2
	5	<input type="checkbox"/>	MMS1900L-DIN-C	73.0	101.5	102.5	153.5	150	3.5	20	1
	3	<input checked="" type="checkbox"/>	MMS1900X3DB	60.5	98.5	99.5	160.5	157	3.5	20	1
	5	<input checked="" type="checkbox"/>	MMS1900X5DB	98.5	136.5	137.5	198.5	195	3.5	20	1
19.1	3	<input type="checkbox"/>	MMS1910S-DIN	50.8	79.5	80.5	131.5	128	3.5	20	2
	3	<input type="checkbox"/>	MMS1910S-DIN-C	50.8	79.5	80.5	131.5	128	3.5	20	1
	5	<input type="checkbox"/>	MMS1910L-DIN	72.8	101.5	102.5	153.5	150	3.5	20	2
	5	<input type="checkbox"/>	MMS1910L-DIN-C	72.8	101.5	102.5	153.5	150	3.5	20	1
	3	<input type="checkbox"/>	MMS1910X3DB	60.8	101.5	103.5	164.5	161	3.5	20	1
	5	<input type="checkbox"/>	MMS1910X5DB	99.0	140.5	143.5	204.5	201	3.5	20	1
19.2	3	<input type="checkbox"/>	MMS1920S-DIN	50.7	79.5	80.5	131.5	128	3.5	20	2
	3	<input type="checkbox"/>	MMS1920S-DIN-C	50.7	79.5	80.5	131.5	128	3.5	20	1
	5	<input type="checkbox"/>	MMS1920L-DIN	72.7	101.5	102.5	153.5	150	3.5	20	2
	5	<input type="checkbox"/>	MMS1920L-DIN-C	72.7	101.5	102.5	153.5	150	3.5	20	1
	3	<input type="checkbox"/>	MMS1920X3DB	61.1	101.5	103.5	164.5	161	3.5	20	1
	5	<input type="checkbox"/>	MMS1920X5DB	99.5	140.5	143.5	204.5	201	3.5	20	1
19.3	3	<input type="checkbox"/>	MMS1930S-DIN	50.6	79.5	80.5	131.5	128	3.5	20	2
	3	<input type="checkbox"/>	MMS1930S-DIN-C	50.6	79.5	80.5	131.5	128	3.5	20	1
	5	<input type="checkbox"/>	MMS1930L-DIN	72.6	101.5	102.5	153.5	150	3.5	20	2
	5	<input type="checkbox"/>	MMS1930L-DIN-C	72.6	101.5	102.5	153.5	150	3.5	20	1
	3	<input type="checkbox"/>	MMS1930X3DB	61.4	101.5	103.5	164.5	161	3.5	20	1
	5	<input type="checkbox"/>	MMS1930X5DB	100.0	140.5	143.5	204.5	201	3.5	20	1
19.4	3	<input type="checkbox"/>	MMS1940S-DIN	50.4	79.5	80.5	131.5	128	3.5	20	2
	3	<input type="checkbox"/>	MMS1940S-DIN-C	50.4	79.5	80.5	131.5	128	3.5	20	1
	5	<input type="checkbox"/>	MMS1940L-DIN	72.4	101.5	102.5	153.5	150	3.5	20	2
	5	<input type="checkbox"/>	MMS1940L-DIN-C	72.4	101.5	102.5	153.5	150	3.5	20	1
	3	<input type="checkbox"/>	MMS1940X3DB	61.7	101.5	103.5	164.5	161	3.5	20	1
	5	<input type="checkbox"/>	MMS1940X5DB	100.5	140.5	143.5	204.5	201	3.5	20	1
19.5	3	<input type="checkbox"/>	MMS1950S-DIN	50.3	79.5	80.5	131.5	128	3.5	20	2
	3	<input type="checkbox"/>	MMS1950S-DIN-C	50.3	79.5	80.5	131.5	128	3.5	20	1
	5	<input type="checkbox"/>	MMS1950L-DIN	72.3	101.5	102.5	153.5	150	3.5	20	2
	5	<input type="checkbox"/>	MMS1950L-DIN-C	72.3	101.5	102.5	153.5	150	3.5	20	1
	3	<input checked="" type="checkbox"/>	MMS1950X3DB	62.0	101.5	103.5	164.5	161	3.5	20	1
	5	<input checked="" type="checkbox"/>	MMS1950X5DB	101.0	140.5	143.5	204.5	201	3.5	20	1

★ : Lagerstandard in Japan. □ : Herstellung nur auf Anfrage

DC	Bohrtiefe (mm)	Bohrtiefe (L/D)	DP7020	Bestellnummer	Abmessungen (mm)							Typ
					LU	LCF	LH	OAL	LF	PL	DCONMS	
19.6	3	□		MMS1960S-DIN	50.2	79.6	80.6	131.6	128	3.6	20	2
	3	□		MMS1960S-DIN-C	50.2	79.6	80.6	131.6	128	3.6	20	1
	5	□		MMS1960L-DIN	72.2	101.6	102.6	153.6	150	3.6	20	2
	5	□		MMS1960L-DIN-C	72.2	101.6	102.6	153.6	150	3.6	20	1
	3	□		MMS1960X3DB	62.4	103.6	103.6	164.6	161	3.6	20	1
	5	□		MMS1960X5DB	101.6	143.6	143.6	204.6	201	3.6	20	1
19.7	3	□		MMS1970S-DIN	50.0	79.6	80.6	131.6	128	3.6	20	2
	3	□		MMS1970S-DIN-C	50.0	79.6	80.6	131.6	128	3.6	20	1
	5	□		MMS1970L-DIN	72.0	101.6	102.6	153.6	150	3.6	20	2
	5	□		MMS1970L-DIN-C	72.0	101.6	102.6	153.6	150	3.6	20	1
	3	□		MMS1970X3DB	62.7	103.6	103.6	164.6	161	3.6	20	1
	5	□		MMS1970X5DB	102.1	143.6	143.6	204.6	201	3.6	20	1
19.8	3	□		MMS1980S-DIN	49.9	79.6	80.6	131.6	128	3.6	20	2
	3	□		MMS1980S-DIN-C	49.9	79.6	80.6	131.6	128	3.6	20	1
	5	□		MMS1980L-DIN	71.9	101.6	102.6	153.6	150	3.6	20	2
	5	□		MMS1980L-DIN-C	71.9	101.6	102.6	153.6	150	3.6	20	1
	3	□		MMS1980X3DB	63.0	103.6	103.6	164.6	161	3.6	20	1
	5	□		MMS1980X5DB	102.6	143.6	143.6	204.6	201	3.6	20	1

DC	Bohrtiefe (mm)	Bohrtiefe (L/D)	DP7020	Bestellnummer	Abmessungen (mm)							Typ
					LU	LCF	LH	OAL	LF	PL	DCONMS	
19.9	3	□		MMS1990S-DIN	49.8	79.6	80.6	131.6	128	3.6	20	2
	3	□		MMS1990S-DIN-C	49.8	79.6	80.6	131.6	128	3.6	20	1
	5	□		MMS1990L-DIN	71.8	101.6	102.6	153.6	150	3.6	20	2
	5	□		MMS1990L-DIN-C	71.8	101.6	102.6	153.6	150	3.6	20	1
	3	□		MMS1990X3DB	63.3	103.6	103.6	164.6	161	3.6	20	1
	5	□		MMS1990X5DB	103.1	143.6	143.6	204.6	201	3.6	20	1
20.0	3	□		MMS2000S-DIN	49.6	79.6	80.6	131.6	128	3.6	20	2
	3	□		MMS2000S-DIN-C	49.6	79.6	80.6	131.6	128	3.6	20	1
	5	□		MMS2000L-DIN	71.6	101.6	102.6	153.6	150	3.6	20	2
	5	□		MMS2000L-DIN-C	71.6	101.6	102.6	153.6	150	3.6	20	1
	3	★		MMS2000X3DB	63.6	103.6	103.6	164.6	161	3.6	20	1
	5	★		MMS2000X5DB	103.6	143.6	143.6	204.6	201	3.6	20	1

## EINSATZHINWEISE

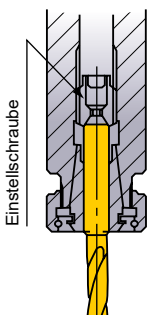
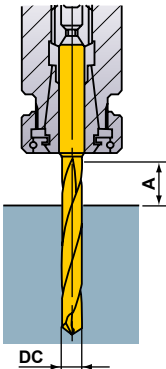
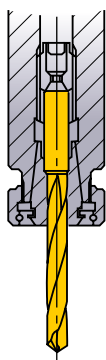
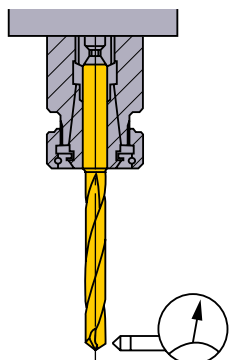
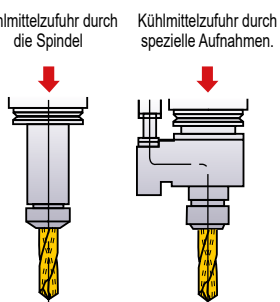
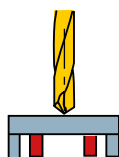
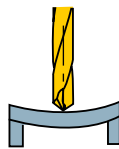
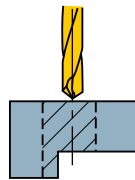
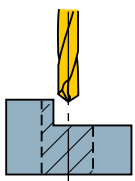
<p><b>Bohrer-Aufnahme</b></p>  <p>Präzisionsspannzangen können verwendet werden.</p>	<p><b>Max. Bohrtiefe</b></p>  <p><math>A \geq DC \times 1.5</math></p>	<p><b>Bohrer-Einstellung</b></p>  <p>Nicht auf den Nuten Spannen.</p>	<p><b>Rundlauftoleranz</b></p>  <p>Rundlaufabweichung <math>\leq 0.03\text{mm}</math></p>
<p><b>Interne Kühlmittelzufuhr</b></p>  <p>Der Kühlmitteldruck beträgt ca. 5 bar—70 bar</p>	<p><b>Handling mit Kühlmittel</b></p> <ol style="list-style-type: none"> <li>1) Schmutz und Staubpartikel in altem Kühlmittel können die Kanäle verstopfen und den Kühlmittelfluss behindern. Es wird empfohlen, das Kühlmittel regelmäßig zu wechseln.</li> <li>2) Feine Metallspäne können die Kühlkanalbohrungen verstopfen. Zur Vorbeugung einen Filter verwenden. Bei Bohrern mit kleinem Durchmesser einen feinen Filter verwenden.</li> </ol>	<p><b>Dünne Werkstücke</b></p>  <p>OK Stützen Sie das Werkstück.</p>  <p>X Wenn Werkstücke verbiegen...</p>	<p><b>Unterbrochene Bearbeitung</b></p>  <p>Ohne Vorbearbeitung OK ① Reduzieren Sie den Vorschub an der unterbrochenen Stelle.</p>  <p>Benötigt Vorbearbeitung ① Planen Sie die Fläche mit einem Fräser vorab.</p>

## SCHNITTDATENEMPFEHLUNGEN

 M  
BOHREN

Bohrer Durchm. DC (mm)	M				M			
	Schnittgeschw. (m/min)	Drehzahl (min <sup>-1</sup> )	Vorschub (min.—max.) (mm/U.)	Tischvorschub (mm/min)	Schnittgeschw. (m/min)	Drehzahl (min <sup>-1</sup> )	Vorschub (min.—max.) (mm/U.)	Tischvorschub (mm/min)
	Rostfreier Stahl (austenitisch) (≤200HB) X5CrNi1810, X5CrNiMo17-12-2				Rostfreier Stahl (austenitisch) (>200HB) X2CrNiN1810, X2CrNiMoN17-12-2			
<b>3.2</b>	80	7900	0.13 (0.08—0.18)	1025	60	5900	0.10 (0.05—0.15)	590
<b>4.0</b>	80	6300	0.15 (0.10—0.20)	945	60	4700	0.12 (0.08—0.18)	560
<b>5.0</b>	80	5000	0.15 (0.10—0.20)	750	60	3800	0.12 (0.08—0.18)	455
<b>6.3</b>	80	4000	0.17 (0.12—0.22)	680	60	3000	0.15 (0.10—0.20)	450
<b>8.0</b>	80	3100	0.19 (0.14—0.24)	585	60	2300	0.17 (0.12—0.22)	390
<b>10.0</b>	60	1900	0.20 (0.15—0.25)	380	50	1500	0.18 (0.13—0.23)	270
<b>12.0</b>	60	1500	0.21 (0.16—0.26)	315	50	1300	0.19 (0.14—0.24)	245
<b>16.0</b>	60	1100	0.22 (0.17—0.27)	240	50	900	0.20 (0.15—0.25)	180
<b>20.0</b>	60	900	0.23 (0.18—0.28)	205	50	700	0.21 (0.16—0.26)	145

Bohrer Durchm. DC (mm)	M				M			
	Schnittgeschw. (m/min)	Drehzahl (min <sup>-1</sup> )	Vorschub (min.—max.) (mm/U.)	Tischvorschub (mm/min)	Schnittgeschw. (m/min)	Drehzahl (min <sup>-1</sup> )	Vorschub (min.—max.) (mm/U.)	Tischvorschub (mm/min)
	Duplex, rostfreier Stahl (≤280HB) X3CrNiMoN27-5-2				Rostfreie Stähle, austenitisch und martensitisch (≤200HB) X10Cr13, X6Cr17			
<b>3.2</b>	50	4900	0.10 (0.05—0.15)	490	80	7900	0.13 (0.08—0.18)	1025
<b>4.0</b>	50	3900	0.12 (0.08—0.18)	465	80	6300	0.15 (0.10—0.20)	945
<b>5.0</b>	50	3100	0.12 (0.08—0.18)	370	80	5000	0.15 (0.10—0.20)	750
<b>6.3</b>	50	2500	0.15 (0.10—0.20)	375	80	4000	0.17 (0.12—0.22)	680
<b>8.0</b>	50	1900	0.17 (0.12—0.22)	320	80	3100	0.19 (0.14—0.24)	585
<b>10.0</b>	40	1200	0.18 (0.13—0.23)	215	60	1900	0.20 (0.15—0.25)	380
<b>12.0</b>	40	1000	0.19 (0.14—0.24)	190	60	1500	0.21 (0.16—0.26)	315
<b>16.0</b>	40	700	0.20 (0.15—0.25)	140	60	1100	0.22 (0.17—0.27)	240
<b>20.0</b>	40	600	0.21 (0.16—0.26)	125	60	900	0.23 (0.18—0.28)	205

Bohrer Durchm. DC (mm)	M				M			
	Schnittgeschw. (m/min)	Drehzahl (min <sup>-1</sup> )	Vorschub (min.—max.) (mm/U.)	Tischvorschub (mm/min)	Schnittgeschw. (m/min)	Drehzahl (min <sup>-1</sup> )	Vorschub (min.—max.) (mm/U.)	Tischvorschub (mm/min)
	Rostfreie Stähle, austenitisch und martensitisch (>200HB) X20CrNi17-2, X30Cr13				Gehärtete rostfreie PH-Stähle (<450HB) X5CrNiCuNb164, X7CrNiAl177, 17-4PH, 17-7PH			
<b>3.2</b>	60	5900	0.10 (0.05—0.15)	590	50	4900	0.10 (0.05—0.15)	490
<b>4.0</b>	60	4700	0.12 (0.08—0.18)	560	50	3900	0.12 (0.08—0.18)	465
<b>5.0</b>	60	3800	0.12 (0.08—0.18)	455	50	3100	0.12 (0.08—0.18)	370
<b>6.3</b>	60	3000	0.15 (0.10—0.20)	450	50	2500	0.15 (0.10—0.20)	375
<b>8.0</b>	60	2300	0.17 (0.12—0.22)	390	50	1900	0.17 (0.12—0.22)	320
<b>10.0</b>	50	1500	0.18 (0.13—0.23)	270	40	1200	0.18 (0.13—0.23)	215
<b>12.0</b>	50	1300	0.19 (0.14—0.24)	245	40	1000	0.19 (0.14—0.24)	190
<b>16.0</b>	50	900	0.20 (0.15—0.25)	180	40	700	0.20 (0.15—0.25)	140
<b>20.0</b>	50	700	0.21 (0.16—0.26)	145	40	600	0.21 (0.16—0.26)	125

Hinweis 1) Für stabiles Bohren empfehlen wir die Zugabe von Kühlmittel unter hohem Druck.

Hinweis 2) Als Kühlmittel empfehlen wir Emulsion.

Hinweis 3) Bei Einsatz von nicht wasserlöslichem Kühlmittel empfehlen wir die Drehzahl um 10–20% zu reduzieren.



## WERKSTOFFVERGLEICHSTABELLE FÜR ROSTFREIE STÄHLE

Material		Deutschland		USA	Japan
		W-no.	DIN	AISI/SAE	JIS
Rostfreie Stähle austenitisch und martensitisch	≤200HB	1.4005	X12CrS3	416	SUS416
		1.4006	X10Cr13	410	SUS410
		1.4016	X6Cr17	430	SUS430
		1.4113	X6CrMo17	434	SUS434
		1.4510	X6CrTi17	430Ti	SUS430LX
		1.4512	X6CrTi12	409	—
	>200HB	1.4021	X20Cr13	420	SUS420J1
		1.4057	X20CrNi17-2	431	SUS431
		1.4028	X30Cr13	420	SUS420J2
		1.4125	X10CrMo17	440C	SUS440C
PH Rostfreier Stahl	<450HB	1.4542	X5CrNiCuNb16 4	630 (17-4PH)	SUS630
		1.4545	—	S15500 (15-5PH)	—
		1.4568	X7CrNiAl17 7	631 (17-7PH)	SUS631
Rostfreier Stahl (austenitisch)	≤200HB	1.4301	X5CrNi18 10	304	SUS304
		1.4303	X5CrNi8-12	305	SUS305
		1.4305	X12CrNiS18-9	303	SUS303
		1.4307	X2CrNi19-11	304L	SUS304L
		1.4401	X5CrNiMo17 12 2	316	SUS316
	>200HB	1.4311	X2CrNiN18 10	304LN	SUS304LN
		1.4404	X2CrNiMo17 12 2	316L	SUS316L
		1.4406	X2CrNiMoN17 12 2	316LN	SUS316LN
		1.4435	X2CrNiMo18 14 3	—	SUS316L
		1.4438	X2CrNiMo18 15 4	317L	SUS317L
		1.4529	X1NiCrMoCuN25 20 7	N08926	—
		1.4541	X6CrNiTi18-10	321	SUS321
		1.4550	X6CrNiNb18-10	347	SUS347
		1.4571	X6CrNiMoTi17 12 2	316Ti	SUS316Ti
Duplexstahl	≤280HB	1.4362	X2CrNiN23 4	—	—
		1.4410	X2CrNiMoN25 7 4	S32750	SCS14A
		1.4460	X3CrNiMoN27 5 2	329	SUS329J1
		1.4462	X2CrNiMoN22 5 3	S31803	SUS329J3L

# BOHREN (VOLLHARTMETALL)

# DSAS



HARTMETALL

- P
- M
- K
- N
- S
- H

Interne Kühlung



Bei Betrachtung der Beschichtung kann die Farbe je nach Blickwinkel unterschiedlich sein. Dies hat keinen Einfluss auf die Leistung des Bohrers.



DC=3	3<DC≤6	6<DC≤10	10<DC≤15
<sup>0</sup> <sub>-0.018</sub>	<sup>0</sup> <sub>-0.018</sub>	<sup>0</sup> <sub>-0.022</sub>	<sup>0</sup> <sub>-0.027</sub>
DCONMS=6	6<DCONMS≤10	10<DCONMS≤16	
<sup>0</sup> <sub>-0.018</sub>	<sup>0</sup> <sub>-0.009</sub>	<sup>0</sup> <sub>-0.011</sub>	

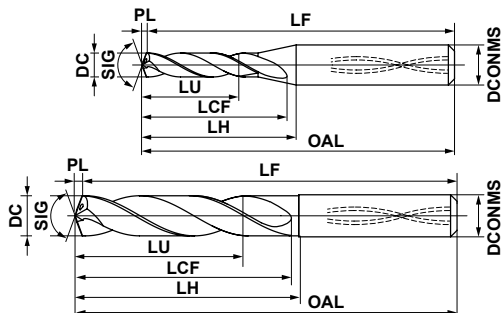

Typ 1

Typ 2

BOHREN

M

DC (mm)	Bohrtiefe (L/D)	DP9020	Bestellnummer	Abmessungen (mm)							Typ
				LU	LCF	LH	OAL	LF	PL	DCONMS	
3.00	3	●	DSAS0300X03S060	9.5	21.5	23.5	70.5	70	0.5	6	1
3.00	5	●	DSAS0300X05S060	15.5	28.5	31.5	78.5	78	0.5	6	1
3.10	3	●	DSAS0310X03S060	9.9	21.6	23.6	70.6	70	0.6	6	1
3.10	5	●	DSAS0310X05S060	16.1	28.6	31.6	78.6	78	0.6	6	1
3.18	3	●	DSAS0318X03S060	10.1	21.6	23.6	70.6	70	0.6	6	1
3.18	5	●	DSAS0318X05S060	16.5	28.6	31.6	78.6	78	0.6	6	1
3.20	3	●	DSAS0320X03S060	10.2	21.6	23.6	70.6	70	0.6	6	1
3.20	5	●	DSAS0320X05S060	16.6	28.6	31.6	78.6	78	0.6	6	1
3.26	3	●	DSAS0326X03S060	10.4	21.6	23.6	70.6	70	0.6	6	1
3.26	5	●	DSAS0326X05S060	16.9	28.6	31.6	78.6	78	0.6	6	1
3.30	3	●	DSAS0330X03S060	10.5	21.6	23.6	70.6	70	0.6	6	1
3.30	5	●	DSAS0330X05S060	17.1	28.6	31.6	78.6	78	0.6	6	1
3.40	3	●	DSAS0340X03S060	10.8	21.6	23.6	70.6	70	0.6	6	1
3.40	5	●	DSAS0340X05S060	17.6	28.6	31.6	78.6	78	0.6	6	1
3.50	3	●	DSAS0350X03S060	11.1	21.6	23.6	70.6	70	0.6	6	1
3.50	5	●	DSAS0350X05S060	18.1	28.6	31.6	78.6	78	0.6	6	1
3.57	3	●	DSAS0357X03S060	11.4	22.7	23.7	70.7	70	0.7	6	1
3.57	5	●	DSAS0357X05S060	18.6	30.7	31.7	78.7	78	0.7	6	1
3.60	3	●	DSAS0360X03S060	11.5	22.7	23.7	70.7	70	0.7	6	1
3.60	5	●	DSAS0360X05S060	18.7	30.7	31.7	78.7	78	0.7	6	1
3.70	3	●	DSAS0370X03S060	11.8	22.7	23.7	70.7	70	0.7	6	1
3.70	5	●	DSAS0370X05S060	19.2	30.7	31.7	78.7	78	0.7	6	1
3.80	3	●	DSAS0380X03S060	12.1	22.7	23.7	70.7	70	0.7	6	1
3.80	5	●	DSAS0380X05S060	19.7	30.7	31.7	78.7	78	0.7	6	1
3.90	3	●	DSAS0390X03S060	12.4	22.7	23.7	70.7	70	0.7	6	1
3.90	5	●	DSAS0390X05S060	20.2	30.7	31.7	78.7	78	0.7	6	1
3.97	3	●	DSAS0397X03S060	12.6	22.7	23.7	70.7	70	0.7	6	1
3.97	5	●	DSAS0397X05S060	20.5	30.7	31.7	78.7	78	0.7	6	1
4.00	3	●	DSAS0400X03S060	12.7	22.7	23.7	70.7	70	0.7	6	1
4.00	5	●	DSAS0400X05S060	20.7	30.7	31.7	78.7	78	0.7	6	1
4.10	3	●	DSAS0410X03S060	13.0	24.7	26.7	73.7	73	0.7	6	1
4.10	5	●	DSAS0410X05S060	21.2	33.7	35.7	82.7	82	0.7	6	1
4.20	3	●	DSAS0420X03S060	13.4	24.8	26.8	73.8	73	0.8	6	1
4.20	5	●	DSAS0420X05S060	21.8	33.8	35.8	82.8	82	0.8	6	1
4.30	3	●	DSAS0430X03S060	13.7	24.8	26.8	73.8	73	0.8	6	1
4.30	5	●	DSAS0430X05S060	22.3	33.8	35.8	82.8	82	0.8	6	1
4.37	3	●	DSAS0437X03S060	13.9	24.8	26.8	73.8	73	0.8	6	1
4.37	5	●	DSAS0437X05S060	22.6	33.8	35.8	82.8	82	0.8	6	1
4.40	3	●	DSAS0440X03S060	14.0	24.8	26.8	73.8	73	0.8	6	1
4.40	5	●	DSAS0440X05S060	22.8	33.8	35.8	82.8	82	0.8	6	1

Hinweis 1) Die Kühlkanall Bohrungen bei Bohrern mit Schneidendurchmesser Ø5 mm oder weniger sind rund.

● : Lagerstandard.

DC (mm)	Bohrtiefe (L/D)	DP9020	Bestellnummer	Abmessungen (mm)							Typ
				LU	LCF	LH	OAL	LF	PL	DCONMS	
4.50	3	●	DSAS0450X03S060	14.3	24.8	26.8	73.8	73	0.8	6	1
4.50	5	●	DSAS0450X05S060	23.3	33.8	35.8	82.8	82	0.8	6	1
4.60	3	●	DSAS0460X03S060	14.6	25.8	28.8	75.8	75	0.8	6	1
4.60	5	●	DSAS0460X05S060	23.8	35.8	38.8	85.8	85	0.8	6	1
4.70	3	●	DSAS0470X03S060	15.0	25.9	28.9	75.9	75	0.9	6	1
4.70	5	●	DSAS0470X05S060	24.4	35.9	38.9	85.9	85	0.9	6	1
4.76	3	●	DSAS0476X03S060	15.2	25.9	28.9	75.9	75	0.9	6	1
4.76	5	●	DSAS0476X05S060	24.7	35.9	38.9	85.9	85	0.9	6	1
4.80	3	●	DSAS0480X03S060	15.3	25.9	28.9	75.9	75	0.9	6	1
4.80	5	●	DSAS0480X05S060	24.9	35.9	38.9	85.9	85	0.9	6	1
4.86	3	●	DSAS0486X03S060	15.5	25.9	28.9	75.9	75	0.9	6	1
4.86	5	●	DSAS0486X05S060	25.2	35.9	38.9	85.9	85	0.9	6	1
4.90	3	●	DSAS0490X03S060	15.6	25.9	28.9	75.9	75	0.9	6	1
4.90	5	●	DSAS0490X05S060	25.4	35.9	38.9	85.9	85	0.9	6	1
5.00	3	●	DSAS0500X03S060	15.9	28.9	29.9	81.9	81	0.9	6	2
5.00	5	●	DSAS0500X05S060	25.9	39.9	42.9	89.9	89	0.9	6	2
5.10	3	●	DSAS0510X03S060	16.2	28.9	29.9	81.9	81	0.9	6	2
5.10	5	●	DSAS0510X05S060	26.4	39.9	42.9	89.9	89	0.9	6	2
5.16	3	●	DSAS0516X03S060	16.5	29.0	30.0	82.0	81	1.0	6	2
5.16	5	●	DSAS0516X05S060	26.8	40.0	43.0	90.0	89	1.0	6	2
5.20	3	●	DSAS0520X03S060	16.6	29.0	30.0	82.0	81	1.0	6	2
5.20	5	●	DSAS0520X05S060	27.0	40.0	43.0	90.0	89	1.0	6	2
5.30	3	●	DSAS0530X03S060	16.9	29.0	30.0	82.0	81	1.0	6	2
5.30	5	●	DSAS0530X05S060	27.5	40.0	43.0	90.0	89	1.0	6	2
5.40	3	●	DSAS0540X03S060	17.2	29.0	30.0	82.0	81	1.0	6	2
5.40	5	●	DSAS0540X05S060	28.0	40.0	43.0	90.0	89	1.0	6	2
5.50	3	●	DSAS0550X03S060	17.5	29.0	30.0	82.0	81	1.0	6	2
5.50	5	●	DSAS0550X05S060	28.5	40.0	43.0	90.0	89	1.0	6	2
5.56	3	●	DSAS0556X03S060	17.8	31.1	31.1	82.1	81	1.1	6	2
5.56	5	●	DSAS0556X05S060	28.9	43.1	43.1	90.1	89	1.1	6	2
5.60	3	●	DSAS0560X03S060	17.9	31.1	31.1	82.1	81	1.1	6	2
5.60	5	●	DSAS0560X05S060	29.1	43.1	43.1	90.1	89	1.1	6	2
5.70	3	●	DSAS0570X03S060	18.2	31.1	31.1	82.1	81	1.1	6	2
5.70	5	●	DSAS0570X05S060	29.6	43.1	43.1	90.1	89	1.1	6	2
5.80	3	●	DSAS0580X03S060	18.5	31.1	31.1	82.1	81	1.1	6	2
5.80	5	●	DSAS0580X05S060	30.1	43.1	43.1	90.1	89	1.1	6	2
5.90	3	●	DSAS0590X03S060	18.8	31.1	31.1	82.1	81	1.1	6	2
5.90	5	●	DSAS0590X05S060	30.6	43.1	43.1	90.1	89	1.1	6	2
5.95	3	●	DSAS0595X03S060	19.0	31.1	31.1	82.1	81	1.1	6	2
5.95	5	●	DSAS0595X05S060	30.9	43.1	43.1	90.1	89	1.1	6	2
6.00	3	●	DSAS0600X03S060	19.1	31.1	31.1	82.1	81	1.1	6	2
6.00	5	●	DSAS0600X05S060	31.1	43.1	43.1	90.1	89	1.1	6	2
6.10	3	●	DSAS0610X03S080	19.5	34.2	37.2	87.2	86	1.2	8	2
6.10	5	●	DSAS0610X05S080	31.7	47.2	49.2	96.2	95	1.2	8	2
6.20	3	●	DSAS0620X03S080	19.8	34.2	37.2	87.2	86	1.2	8	2
6.20	5	●	DSAS0620X05S080	32.2	47.2	49.2	96.2	95	1.2	8	2
6.30	3	●	DSAS0630X03S080	20.1	34.2	37.2	87.2	86	1.2	8	2
6.30	5	●	DSAS0630X05S080	32.7	47.2	49.2	96.2	95	1.2	8	2
6.35	3	●	DSAS0635X03S080	20.3	34.2	37.2	87.2	86	1.2	8	2
6.35	5	●	DSAS0635X05S080	33.0	47.2	49.2	96.2	95	1.2	8	2
6.40	3	●	DSAS0640X03S080	20.4	34.2	37.2	87.2	86	1.2	8	2
6.40	5	●	DSAS0640X05S080	33.2	47.2	49.2	96.2	95	1.2	8	2
6.50	3	●	DSAS0650X03S080	20.7	34.2	37.2	87.2	86	1.2	8	2
6.50	5	●	DSAS0650X05S080	33.7	47.2	49.2	96.2	95	1.2	8	2
6.60	3	●	DSAS0660X03S080	21.1	36.3	38.3	91.3	90	1.3	8	2
6.60	5	●	DSAS0660X05S080	34.3	50.3	52.3	99.3	98	1.3	8	2
6.70	3	●	DSAS0670X03S080	21.4	36.3	38.3	91.3	90	1.3	8	2
6.70	5	●	DSAS0670X05S080	34.8	50.3	52.3	99.3	98	1.3	8	2

M

BOHREN

# BOHREN (VOLLHARTMETALL)

# DSAS

HARTMETALL

M

BOHREN

DC (mm)	Bohrtiefe (L/D)	DP9020	Bestellnummer	Abmessungen (mm)							Typ
				LU	LCF	LH	OAL	LF	PL	DCONMS	
6.75	3	●	DSAS0675X03S080	21.5	36.3	38.3	91.3	90	1.3	8	2
6.75	5	●	DSAS0675X05S080	35.0	50.3	52.3	99.3	98	1.3	8	2
6.80	3	●	DSAS0680X03S080	21.7	36.3	38.3	91.3	90	1.3	8	2
6.80	5	●	DSAS0680X05S080	35.3	50.3	52.3	99.3	98	1.3	8	2
6.90	3	●	DSAS0690X03S080	22.0	36.3	38.3	91.3	90	1.3	8	2
6.90	5	●	DSAS0690X05S080	35.8	50.3	52.3	99.3	98	1.3	8	2
6.95	3	●	DSAS0695X03S080	22.2	36.3	38.3	91.3	90	1.3	8	2
6.95	5	●	DSAS0695X05S080	36.1	50.3	52.3	99.3	98	1.3	8	2
7.00	3	●	DSAS0700X03S080	22.3	36.3	38.3	91.3	90	1.3	8	2
7.00	5	●	DSAS0700X05S080	36.3	50.3	52.3	99.3	98	1.3	8	2
7.10	3	●	DSAS0710X03S080	22.7	39.4	40.4	91.4	90	1.4	8	2
7.10	5	●	DSAS0710X05S080	36.9	54.4	57.4	104.4	103	1.4	8	2
7.14	3	●	DSAS0714X03S080	22.8	39.4	40.4	91.4	90	1.4	8	2
7.14	5	●	DSAS0714X05S080	37.1	54.4	57.4	104.4	103	1.4	8	2
7.20	3	●	DSAS0720X03S080	23.0	39.4	40.4	91.4	90	1.4	8	2
7.20	5	●	DSAS0720X05S080	37.4	54.4	57.4	104.4	103	1.4	8	2
7.30	3	●	DSAS0730X03S080	23.3	39.4	40.4	91.4	90	1.4	8	2
7.30	5	●	DSAS0730X05S080	37.9	54.4	57.4	104.4	103	1.4	8	2
7.40	3	●	DSAS0740X03S080	23.6	39.4	40.4	91.4	90	1.4	8	2
7.40	5	●	DSAS0740X05S080	38.4	54.4	57.4	104.4	103	1.4	8	2
7.50	3	●	DSAS0750X03S080	23.9	39.4	40.4	91.4	90	1.4	8	2
7.50	5	●	DSAS0750X05S080	38.9	54.4	57.4	104.4	103	1.4	8	2
7.54	3	●	DSAS0754X03S080	24.1	41.5	41.5	91.5	90	1.5	8	2
7.54	5	●	DSAS0754X05S080	39.2	57.5	57.5	104.5	103	1.5	8	2
7.60	3	●	DSAS0760X03S080	24.3	41.5	41.5	91.5	90	1.5	8	2
7.60	5	●	DSAS0760X05S080	39.5	57.5	57.5	104.5	103	1.5	8	2
7.70	3	●	DSAS0770X03S080	24.6	41.5	41.5	91.5	90	1.5	8	2
7.70	5	●	DSAS0770X05S080	40.0	57.5	57.5	104.5	103	1.5	8	2
7.80	3	●	DSAS0780X03S080	24.9	41.5	41.5	91.5	90	1.5	8	2
7.80	5	●	DSAS0780X05S080	40.5	57.5	57.5	104.5	103	1.5	8	2
7.90	3	●	DSAS0790X03S080	25.2	41.5	41.5	91.5	90	1.5	8	2
7.90	5	●	DSAS0790X05S080	41.0	57.5	57.5	104.5	103	1.5	8	2
7.94	3	●	DSAS0794X03S080	25.3	41.5	41.5	91.5	90	1.5	8	2
7.94	5	●	DSAS0794X05S080	41.2	57.5	57.5	104.5	103	1.5	8	2
8.00	3	●	DSAS0800X03S080	25.5	41.5	41.5	91.5	90	1.5	8	2
8.00	5	●	DSAS0800X05S080	41.5	57.5	57.5	104.5	103	1.5	8	2
8.10	3	●	DSAS0810X03S100	25.8	44.5	47.5	97.5	96	1.5	10	2
8.10	5	●	DSAS0810X05S100	42.0	61.5	63.5	114.5	113	1.5	10	2
8.20	3	●	DSAS0820X03S100	26.1	44.5	47.5	97.5	96	1.5	10	2
8.20	5	●	DSAS0820X05S100	42.5	61.5	63.5	114.5	113	1.5	10	2
8.30	3	●	DSAS0830X03S100	26.4	44.5	47.5	97.5	96	1.5	10	2
8.30	5	●	DSAS0830X05S100	43.0	61.5	63.5	114.5	113	1.5	10	2
8.33	3	●	DSAS0833X03S100	26.5	44.5	47.5	97.5	96	1.5	10	2
8.33	5	●	DSAS0833X05S100	43.2	61.5	63.5	114.5	113	1.5	10	2
8.40	3	●	DSAS0840X03S100	26.7	44.5	47.5	97.5	96	1.5	10	2
8.40	5	●	DSAS0840X05S100	43.5	61.5	63.5	114.5	113	1.5	10	2
8.50	3	●	DSAS0850X03S100	27.0	44.5	47.5	97.5	96	1.5	10	2
8.50	5	●	DSAS0850X05S100	44.0	61.5	63.5	114.5	113	1.5	10	2
8.60	3	●	DSAS0860X03S100	27.4	46.6	48.6	102.6	101	1.6	10	2
8.60	5	●	DSAS0860X05S100	44.6	64.6	66.6	117.6	116	1.6	10	2
8.70	3	●	DSAS0870X03S100	27.7	46.6	48.6	102.6	101	1.6	10	2
8.70	5	●	DSAS0870X05S100	45.1	64.6	66.6	117.6	116	1.6	10	2
8.73	3	●	DSAS0873X03S100	27.8	46.6	48.6	102.6	101	1.6	10	2
8.73	5	●	DSAS0873X05S100	45.3	64.6	66.6	117.6	116	1.6	10	2
8.80	3	●	DSAS0880X03S100	28.0	46.6	48.6	102.6	101	1.6	10	2
8.80	5	●	DSAS0880X05S100	45.6	64.6	66.6	117.6	116	1.6	10	2
8.90	3	●	DSAS0890X03S100	28.3	46.6	48.6	102.6	101	1.6	10	2
8.90	5	●	DSAS0890X05S100	46.1	64.6	66.6	117.6	116	1.6	10	2

● : Lagerstandard.

DC (mm)	Bohrtiefe (L/D)	DP9020	Bestellnummer	Abmessungen (mm)							Typ
				LU	LCF	LH	OAL	LF	PL	DCONMS	
9.00	3	●	DSAS0900X03S100	28.6	46.6	48.6	102.6	101	1.6	10	2
9.00	5	●	DSAS0900X05S100	46.6	64.6	66.6	117.6	116	1.6	10	2
9.10	3	●	DSAS0910X03S100	29.1	49.8	50.8	102.8	101	1.8	10	2
9.10	5	●	DSAS0910X05S100	47.3	68.8	71.8	122.8	121	1.8	10	2
9.20	3	●	DSAS0920X03S100	29.4	49.8	50.8	102.8	101	1.8	10	2
9.20	5	●	DSAS0920X05S100	47.8	68.8	71.8	122.8	121	1.8	10	2
9.30	3	●	DSAS0930X03S100	29.7	49.8	50.8	102.8	101	1.8	10	2
9.30	5	●	DSAS0930X05S100	48.3	68.8	71.8	122.8	121	1.8	10	2
9.40	3	●	DSAS0940X03S100	30.0	49.8	50.8	102.8	101	1.8	10	2
9.40	5	●	DSAS0940X05S100	48.8	68.8	71.8	122.8	121	1.8	10	2
9.50	3	●	DSAS0950X03S100	30.3	49.8	50.8	102.8	101	1.8	10	2
9.50	5	●	DSAS0950X05S100	49.3	68.8	71.8	122.8	121	1.8	10	2
9.53	3	●	DSAS0953X03S100	30.4	49.8	50.8	102.8	101	1.8	10	2
9.53	5	●	DSAS0953X05S100	49.4	68.8	71.8	122.8	121	1.8	10	2
9.60	3	●	DSAS0960X03S100	30.6	49.8	50.8	102.8	101	1.8	10	2
9.60	5	●	DSAS0960X05S100	49.8	68.8	71.8	122.8	121	1.8	10	2
9.70	3	●	DSAS0970X03S100	30.9	49.8	50.8	102.8	101	1.8	10	2
9.70	5	●	DSAS0970X05S100	50.3	68.8	71.8	122.8	121	1.8	10	2
9.80	3	●	DSAS0980X03S100	31.2	51.8	51.8	102.8	101	1.8	10	2
9.80	5	●	DSAS0980X05S100	50.8	71.8	71.8	122.8	121	1.8	10	2
9.90	3	●	DSAS0990X03S100	31.5	51.9	51.8	102.8	101	1.8	10	2
9.90	5	●	DSAS0990X05S100	51.3	71.8	71.8	122.8	121	1.8	10	2
9.92	3	●	DSAS0992X03S100	31.6	51.8	51.8	102.8	101	1.8	10	2
9.92	5	●	DSAS0992X05S100	51.4	71.8	71.8	122.8	121	1.8	10	2
10.00	3	●	DSAS1000X03S100	31.8	51.8	51.8	102.8	101	1.8	10	2
10.00	5	●	DSAS1000X05S100	51.8	71.8	71.8	122.8	121	1.8	10	2
10.10	3	●	DSAS1010X03S120	32.2	54.9	57.9	112.9	111	1.9	12	2
10.10	5	●	DSAS1010X05S120	52.4	75.9	79.9	135.9	134	1.9	12	2
10.20	3	●	DSAS1020X03S120	32.5	54.9	57.9	112.9	111	1.9	12	2
10.20	5	●	DSAS1020X05S120	52.9	75.9	79.9	135.9	134	1.9	12	2
10.30	3	●	DSAS1030X03S120	32.8	54.9	57.9	112.9	111	1.9	12	2
10.30	5	●	DSAS1030X05S120	53.4	75.9	79.9	135.9	134	1.9	12	2
10.32	3	●	DSAS1032X03S120	32.9	54.9	57.9	112.9	111	1.9	12	2
10.32	5	●	DSAS1032X05S120	53.5	75.9	79.9	135.9	134	1.9	12	2
10.40	3	●	DSAS1040X03S120	33.1	54.9	57.9	112.9	111	1.9	12	2
10.40	5	●	DSAS1040X05S120	53.9	75.9	79.9	135.9	134	1.9	12	2
10.50	3	●	DSAS1050X03S120	33.4	54.9	57.9	112.9	111	1.9	12	2
10.50	5	●	DSAS1050X05S120	54.4	75.9	79.9	135.9	134	1.9	12	2
10.60	3	●	DSAS1060X03S120	33.7	54.9	57.9	112.9	111	1.9	12	2
10.60	5	●	DSAS1060X05S120	54.9	75.9	79.9	135.9	134	1.9	12	2
10.70	3	●	DSAS1070X03S120	34.0	54.9	57.9	112.9	111	1.9	12	2
10.70	5	●	DSAS1070X05S120	55.4	75.9	79.9	135.9	134	1.9	12	2
10.72	3	●	DSAS1072X03S120	34.1	57.0	59.0	118.0	116	2.0	12	2
10.72	5	●	DSAS1072X05S120	55.6	79.0	80.0	142.0	140	2.0	12	2
10.80	3	●	DSAS1080X03S120	34.4	57.0	59.0	118.0	116	2.0	12	2
10.80	5	●	DSAS1080X05S120	56.0	79.0	80.0	142.0	140	2.0	12	2
10.90	3	●	DSAS1090X03S120	34.7	57.0	59.0	118.0	116	2.0	12	2
10.90	5	●	DSAS1090X05S120	56.5	79.0	80.0	142.0	140	2.0	12	2
11.00	3	●	DSAS1100X03S120	35.0	57.0	59.0	118.0	116	2.0	12	2
11.00	5	●	DSAS1100X05S120	57.0	79.0	80.0	142.0	140	2.0	12	2
11.10	3	●	DSAS1110X03S120	35.4	60.1	61.1	118.1	116	2.1	12	2
11.10	5	●	DSAS1110X05S120	57.6	83.1	86.1	142.1	140	2.1	12	2
11.11	3	●	DSAS1111X03S120	35.4	60.1	61.1	118.1	116	2.1	12	2
11.11	5	●	DSAS1111X05S120	57.7	83.1	86.1	142.1	140	2.1	12	2
11.20	3	●	DSAS1120X03S120	35.7	60.1	61.1	118.1	116	2.1	12	2
11.20	5	●	DSAS1120X05S120	58.1	83.1	86.1	142.1	140	2.1	12	2
11.30	3	●	DSAS1130X03S120	36.0	60.1	61.1	118.1	116	2.1	12	2
11.30	5	●	DSAS1130X05S120	58.6	83.1	86.1	142.1	140	2.1	12	2

M

BOHREN

# BOHREN (VOLLHARTMETALL)

HARTMETALL

# DSAS

M  
BOHREN

DC (mm)	Bohrtiefe (L/D)	DP9020	Bestellnummer	Abmessungen (mm)							Typ
				LU	LCF	LH	OAL	LF	PL	DCONMS	
11.40	3	●	DSAS1140X03S120	36.3	60.1	61.1	118.1	116	2.1	12	2
11.40	5	●	DSAS1140X05S120	59.1	83.1	86.1	142.1	140	2.1	12	2
11.50	3	●	DSAS1150X03S120	36.6	60.1	61.1	118.1	116	2.1	12	2
11.50	5	●	DSAS1150X05S120	59.6	83.1	86.1	142.1	140	2.1	12	2
11.51	3	●	DSAS1151X03S120	36.7	62.2	62.2	118.2	116	2.2	12	2
11.51	5	●	DSAS1151X05S120	59.7	86.2	86.2	142.2	140	2.2	12	2
11.60	3	●	DSAS1160X03S120	37.0	62.2	62.2	118.2	116	2.2	12	2
11.60	5	●	DSAS1160X05S120	60.2	86.2	86.2	142.2	140	2.2	12	2
11.70	3	●	DSAS1170X03S120	37.3	62.2	62.2	118.2	116	2.2	12	2
11.70	5	●	DSAS1170X05S120	60.7	86.2	86.2	142.2	140	2.2	12	2
11.80	3	●	DSAS1180X03S120	37.6	62.2	62.2	118.2	116	2.2	12	2
11.80	5	●	DSAS1180X05S120	61.2	86.2	86.2	142.2	140	2.2	12	2
11.90	3	●	DSAS1190X03S120	37.9	62.2	62.2	118.2	116	2.2	12	2
11.90	5	●	DSAS1190X05S120	61.7	86.2	86.2	142.2	140	2.2	12	2
12.00	3	●	DSAS1200X03S120	38.2	62.2	62.2	118.2	116	2.2	12	2
12.00	5	●	DSAS1200X05S120	62.2	86.2	86.2	142.2	140	2.2	12	2

● : Lagerstandard.

## SCHNITTDATENEMPFEHLUNGEN

Material		S			
		Hitzebeständige Legierung		Titanlegierung	
		Inconel®718 usw.		Ti-6Al-4V usw.	
Bohrer Durchm. DC (mm)	L/D	Drehzahl (min <sup>-1</sup> )	Vorschub (min.—max.) (mm/U.)	Drehzahl (min <sup>-1</sup> )	Vorschub (min.—max.) (mm/U.)
<b>3</b>	≤ 5	1000	0.06 (0.04—0.10)	4200	0.08 (0.06—0.12)
<b>4</b>	≤ 5	790	0.06 (0.04—0.10)	3100	0.10 (0.08—0.16)
<b>5</b>	≤ 5	760	0.08 (0.06—0.12)	2500	0.12 (0.08—0.20)
<b>6</b>	≤ 5	790	0.10 (0.08—0.15)	2100	0.14 (0.10—0.20)
<b>8</b>	≤ 5	590	0.10 (0.08—0.15)	1600	0.18 (0.15—0.25)
<b>10</b>	≤ 5	570	0.10 (0.08—0.15)	1300	0.22 (0.18—0.28)
<b>12</b>	≤ 5	530	0.12 (0.08—0.15)	1100	0.24 (0.20—0.30)

Hinweis 1) Für prozesssicheres Bohren wird die Zugabe von Kühlmittel unter hohem Druck empfohlen.

Hinweis 2) Es wird ein wasserlösliches Kühlmittel nämlich „Emulsion“ empfohlen.

Hinweis 3) Wenn nicht wasserlösliches Kühlmittel verwendet wird, bitte die Schnittgeschwindigkeit um 10-20 % verringern.

Hinweis 4) Beim Einsatz von externer Kühlmittelzufuhr sollte beim Tieflochbohren das Entlüften durchgeführt werden, um den Spanbruch zu fördern.

M

BOHREN

# BOHREN (VOLLHARTMETALL)

# MNS



- P M K **N** S H

Interne Kühlung



	DC=3	3<DC≤6	6<DC≤10	10<DC≤18	18<DC≤20
DIN-Typ	+0.016 +0.004	+0.016 +0.004	+0.021 +0.006	+0.025 +0.007	+0.029 +0.008
Andere	0 -0.014	0 -0.018	0 -0.022	0 -0.027	0 -0.031
h6	-0.006	-0.008	-0.009	-0.011	-0.013

- Bohrer mit einem Durchmesser von 4.5 mm oder weniger sind mit 2 Kühlmittelbohrungen versehen.
- Bohrer mit einem Durchmesser von 4.6 mm oder größer sind mit 4 Kühlmittelbohrungen versehen.

● Typ 1 MNS---DIN-C, MNS-C, MNS---LB, MNS---DB (Zylind. Schaft)

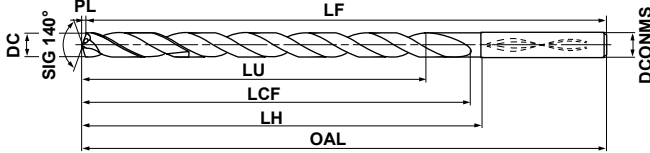

● Typ 2 MNS---S/L-DIN (Schaft mit Whistle Notch)

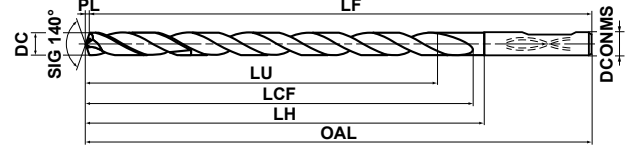

● Typ 3 MNS---DIN-C, MNS-C, MNS---LB, MNS---DB (Zylind. Schaft)

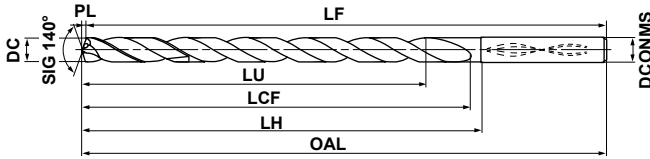

● Typ 4 MNS---S/L-DIN (Schaft mit Whistle Notch)

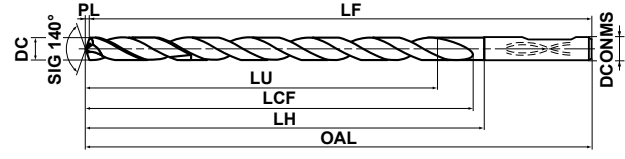

● MNS Bohrer eignen sich für die Verwendung mit Schrumpfaufnahmen.

DC (mm)	Bohrtiefe (L/D)	TF15	Bestellnummer	Abmessungen (mm)							Typ
				LU	LCF	LH	OAL	LF	PL	DCONMS	
3.0	3	□	MNS0300S-DIN	15.0	19.5	24.5	61.5	61	0.5	6	2
	3	□	MNS0300S-DIN-C	15.0	19.5	24.5	61.5	61	0.5	6	1
	5	□	MNS0300L-DIN	23.0	27.5	28.5	65.5	65	0.5	6	2
	5	●	MNS0300L-DIN-C	23.0	27.5	28.5	65.5	65	0.5	6	1
	8	□	MNS0300-L8C	24.5	33.5	36.5	73.5	73	0.5	6	1
	10	□	MNS0300-L10C	30.5	39.5	42.5	79.5	79	0.5	6	1
	12	●	MNS0300-L12C	36.5	45.5	48.5	85.5	85	0.5	6	1
	15	□	MNS0300-L15C	45.5	54.5	57.5	94.5	94	0.5	6	1
	20	●	MNS0300-L20C	60.5	69.5	72.5	109.5	109	0.5	6	1
	25	□	MNS0300-L25C	75.5	84.5	87.5	124.5	124	0.5	6	1
	30	●	MNS0300-L30C	90.5	99.5	102.5	139.5	139	0.5	6	1
	5	★	MNS0300LB	15.5	33.5	33.5	81.5	81	0.5	3	1
10	★	MNS0300X10DB	30.5	39.5	42.5	90.5	90	0.5	3	1	
20	★	MNS0300X20DB	60.5	69.5	72.5	120.5	120	0.5	3	1	
30	★	MNS0300X30DB	90.5	99.5	102.5	150.5	150	0.5	3	1	
3.1	3	□	MNS0310S-DIN	14.9	19.6	24.6	61.6	61	0.6	6	2
	3	□	MNS0310S-DIN-C	14.9	19.6	24.6	61.6	61	0.6	6	1
	5	□	MNS0310L-DIN	22.9	27.6	28.6	65.6	65	0.6	6	2
	5	□	MNS0310L-DIN-C	22.9	27.6	28.6	65.6	65	0.6	6	1
	8	□	MNS0310-L8C	25.4	39.6	42.6	79.6	79	0.6	6	1
	10	□	MNS0310-L10C	31.6	46.6	49.6	86.6	86	0.6	6	1
	12	□	MNS0310-L12C	37.8	53.6	56.6	93.6	93	0.6	6	1
	15	□	MNS0310-L15C	47.1	63.6	66.6	103.6	103	0.6	6	1
	20	□	MNS0310-L20C	62.6	81.6	84.6	121.6	121	0.6	6	1
	25	□	MNS0310-L25C	78.1	98.6	101.6	138.6	138	0.6	6	1
	30	□	MNS0310-L30C	93.6	116.6	119.6	156.6	156	0.6	6	1
	5	★	MNS0310LB	16.1	39.6	39.6	87.6	87	0.6	4	1
10	□	MNS0310X10DB	31.6	46.6	49.6	97.6	97	0.6	4	1	
20	□	MNS0310X20DB	62.6	81.6	84.6	132.6	132	0.6	4	1	
30	□	MNS0310X30DB	93.6	116.6	119.6	167.6	167	0.6	4	1	

DC (mm)	Bohrtiefe (L/D)	TF15	Bestellnummer	Abmessungen (mm)							Typ
				LU	LCF	LH	OAL	LF	PL	DCONMS	
3.2	3	□	MNS0320S-DIN	14.8	19.6	24.6	61.6	61	0.6	6	2
	3	□	MNS0320S-DIN-C	14.8	19.6	24.6	61.6	61	0.6	6	1
	5	□	MNS0320L-DIN	22.8	27.6	28.6	65.6	65	0.6	6	2
	5	●	MNS0320L-DIN-C	22.8	27.6	28.6	65.6	65	0.6	6	1
	8	□	MNS0320-L8C	26.2	39.6	42.6	79.6	79	0.6	6	1
	10	□	MNS0320-L10C	32.6	46.6	49.6	86.6	86	0.6	6	1
	12	●	MNS0320-L12C	39.0	53.6	56.6	93.6	93	0.6	6	1
	15	□	MNS0320-L15C	48.6	63.6	66.6	103.6	103	0.6	6	1
	20	●	MNS0320-L20C	64.6	81.6	84.6	121.6	121	0.6	6	1
	25	□	MNS0320-L25C	80.6	98.6	101.6	138.6	138	0.6	6	1
	30	●	MNS0320-L30C	96.6	116.6	119.6	156.6	156	0.6	6	1
	5	★	MNS0320LB	16.6	39.6	39.6	87.6	87	0.6	4	1
10	★	MNS0320X10DB	32.6	46.6	49.6	97.6	97	0.6	4	1	
20	★	MNS0320X20DB	64.6	81.6	84.6	132.6	132	0.6	4	1	
30	★	MNS0320X30DB	96.6	116.6	119.6	167.6	167	0.6	4	1	
3.3	3	□	MNS0330S-DIN	14.7	19.6	24.6	61.6	61	0.6	6	2
	3	□	MNS0330S-DIN-C	14.7	19.6	24.6	61.6	61	0.6	6	1
	5	□	MNS0330L-DIN	22.7	27.6	28.6	65.6	65	0.6	6	2
	5	●	MNS0330L-DIN-C	22.7	27.6	28.6	65.6	65	0.6	6	1
	8	□	MNS0330-L8C	27.0	39.6	42.6	79.6	79	0.6	6	1
	10	□	MNS0330-L10C	33.6	46.6	49.6	86.6	86	0.6	6	1
	12	●	MNS0330-L12C	40.2	53.6	56.6	93.6	93	0.6	6	1
	15	□	MNS0330-L15C	50.1	63.6	66.6	103.6	103	0.6	6	1
	20	●	MNS0330-L20C	66.6	81.6	84.6	121.6	121	0.6	6	1
	25	□	MNS0330-L25C	83.1	98.6	101.6	138.6	138	0.6	6	1
	30	●	MNS0330-L30C	99.6	116.6	119.6	156.6	156	0.6	6	1
	5	★	MNS0330LB	17.1	39.6	39.6	87.6	87	0.6	4	1
10	□	MNS0330X10DB	33.6	46.6	49.6	97.6	97	0.6	4	1	
20	□	MNS0330X20DB	66.6	81.6	84.6	132.6	132	0.6	4	1	
30	□	MNS0330X30DB	99.6	116.6	119.6	167.6	167	0.6	4	1	

Hinweis 1) Bei Bedarf von abweichenden Geometrien setzen Sie sich mit uns in Verbindung. (Andere Durchmesser und Längen können bestellt werden).

● : Lagerstandard. ★ : Lagerstandard in Japan.

□ : Herstellung nur auf Anfrage



DC	Bohrtiefe (mm)	TF15 (L/D)	Bestellnummer	Abmessungen (mm)							Typ
				LU	LCF	LH	OAL	LF	PL	DCONMS	
3.4	3	□	MNS0340S-DIN	14.5	19.6	24.6	61.6	61	0.6	6	2
	3	□	MNS0340S-DIN-C	14.5	19.6	24.6	61.6	61	0.6	6	1
	5	□	MNS0340L-DIN	22.5	27.6	28.6	65.6	65	0.6	6	2
	5	□	MNS0340L-DIN-C	22.5	27.6	28.6	65.6	65	0.6	6	1
	8	□	MNS0340-L8C	27.8	39.6	42.6	79.6	79	0.6	6	1
	10	□	MNS0340-L10C	34.6	46.6	49.6	86.6	86	0.6	6	1
	12	□	MNS0340-L12C	41.4	53.6	56.6	93.6	93	0.6	6	1
	15	□	MNS0340-L15C	51.6	63.6	66.6	103.6	103	0.6	6	1
	20	□	MNS0340-L20C	68.6	81.6	84.6	121.6	121	0.6	6	1
	25	□	MNS0340-L25C	85.6	98.6	101.6	138.6	138	0.6	6	1
	30	□	MNS0340-L30C	102.6	116.6	119.6	156.6	156	0.6	6	1
	5	★	MNS0340LB	17.6	39.6	39.6	87.6	87	0.6	4	1
	10	★	MNS0340X10DB	34.6	46.6	49.6	97.6	97	0.6	4	1
	20	★	MNS0340X20DB	68.6	81.6	84.6	132.6	132	0.6	4	1
	30	★	MNS0340X30DB	102.6	116.6	119.6	167.6	167	0.6	4	1
3.5	3	□	MNS0350S-DIN	14.4	19.6	24.6	61.6	61	0.6	6	2
	3	□	MNS0350S-DIN-C	14.4	19.6	24.6	61.6	61	0.6	6	1
	5	□	MNS0350L-DIN	22.4	27.6	28.6	65.6	65	0.6	6	2
	5	●	MNS0350L-DIN-C	22.4	27.6	28.6	65.6	65	0.6	6	1
	8	□	MNS0350-L8C	28.6	39.6	42.6	79.6	79	0.6	6	1
	10	□	MNS0350-L10C	35.6	46.6	49.6	86.6	86	0.6	6	1
	12	●	MNS0350-L12C	42.6	53.6	56.6	93.6	93	0.6	6	1
	15	□	MNS0350-L15C	53.1	63.6	66.6	103.6	103	0.6	6	1
	20	●	MNS0350-L20C	70.6	81.6	84.6	121.6	121	0.6	6	1
	25	□	MNS0350-L25C	88.1	98.6	101.6	138.6	138	0.6	6	1
	30	●	MNS0350-L30C	105.6	116.6	119.6	156.6	156	0.6	6	1
	5	★	MNS0350LB	18.1	39.6	39.6	87.6	87	0.6	4	1
	10	□	MNS0350X10DB	35.6	46.6	49.6	97.6	97	0.6	4	1
	20	□	MNS0350X20DB	70.6	81.6	84.6	132.6	132	0.6	4	1
	30	□	MNS0350X30DB	105.6	116.6	119.6	167.6	167	0.6	4	1
3.6	3	□	MNS0360S-DIN	14.3	19.7	24.7	61.7	61	0.7	6	2
	3	□	MNS0360S-DIN-C	14.3	19.7	24.7	61.7	61	0.7	6	1
	5	□	MNS0360L-DIN	22.3	27.7	28.7	65.7	65	0.7	6	2
	5	□	MNS0360L-DIN-C	22.3	27.7	28.7	65.7	65	0.7	6	1
	8	□	MNS0360-L8C	29.5	44.7	47.7	84.7	84	0.7	6	1
	10	□	MNS0360-L10C	36.7	52.7	55.7	92.7	92	0.7	6	1
	12	□	MNS0360-L12C	43.9	60.7	63.7	100.7	100	0.7	6	1
	15	□	MNS0360-L15C	54.7	72.7	75.7	112.7	112	0.7	6	1
	20	□	MNS0360-L20C	72.7	92.7	95.7	132.7	132	0.7	6	1
	25	□	MNS0360-L25C	90.7	112.7	115.7	152.7	152	0.7	6	1
	30	□	MNS0360-L30C	108.7	132.7	135.7	172.7	172	0.7	6	1
	5	★	MNS0360LB	18.7	44.7	44.7	92.7	92	0.7	4	1
	10	★	MNS0360X10DB	36.7	52.7	55.7	103.7	103	0.7	4	1
	20	★	MNS0360X20DB	72.7	92.7	95.7	143.7	143	0.7	4	1
	30	★	MNS0360X30DB	108.7	132.7	135.7	183.7	183	0.7	4	1

DC	Bohrtiefe (mm)	TF15 (L/D)	Bestellnummer	Abmessungen (mm)							Typ
				LU	LCF	LH	OAL	LF	PL	DCONMS	
3.7	3	□	MNS0370S-DIN	14.1	19.7	24.7	61.7	61	0.7	6	2
	3	□	MNS0370S-DIN-C	14.1	19.7	24.7	61.7	61	0.7	6	1
	5	□	MNS0370L-DIN	22.1	27.7	28.7	65.7	65	0.7	6	2
	5	□	MNS0370L-DIN-C	22.1	27.7	28.7	65.7	65	0.7	6	1
	8	□	MNS0370-L8C	30.3	44.7	47.7	84.7	84	0.7	6	1
	10	□	MNS0370-L10C	37.7	52.7	55.7	92.7	92	0.7	6	1
	12	□	MNS0370-L12C	45.1	60.7	63.7	100.7	100	0.7	6	1
	15	□	MNS0370-L15C	56.2	72.7	75.7	112.7	112	0.7	6	1
	20	□	MNS0370-L20C	74.7	92.7	95.7	132.7	132	0.7	6	1
	25	□	MNS0370-L25C	93.2	112.7	115.7	152.7	152	0.7	6	1
	30	□	MNS0370-L30C	111.7	132.7	135.7	172.7	172	0.7	6	1
	5	★	MNS0370LB	19.2	44.7	44.7	92.7	92	0.7	4	1
	10	□	MNS0370X10DB	37.7	52.7	55.7	103.7	103	0.7	4	1
	20	□	MNS0370X20DB	74.7	92.7	95.7	143.7	143	0.7	4	1
	30	□	MNS0370X30DB	111.7	132.7	135.7	183.7	183	0.7	4	1
3.8	3	□	MNS0380S-DIN	18.0	23.7	28.7	65.7	65	0.7	6	2
	3	□	MNS0380S-DIN-C	18.0	23.7	28.7	65.7	65	0.7	6	1
	5	□	MNS0380L-DIN	30.0	35.7	36.7	73.7	73	0.7	6	2
	5	□	MNS0380L-DIN-C	30.0	35.7	36.7	73.7	73	0.7	6	1
	8	□	MNS0380-L8C	31.1	44.7	47.7	84.7	84	0.7	6	1
	10	□	MNS0380-L10C	38.7	52.7	55.7	92.7	92	0.7	6	1
	12	□	MNS0380-L12C	46.3	60.7	63.7	100.7	100	0.7	6	1
	15	□	MNS0380-L15C	57.7	72.7	75.7	112.7	112	0.7	6	1
	20	□	MNS0380-L20C	76.7	92.7	95.7	132.7	132	0.7	6	1
	25	□	MNS0380-L25C	95.7	112.7	115.7	152.7	152	0.7	6	1
	30	□	MNS0380-L30C	114.7	132.7	135.7	172.7	172	0.7	6	1
	5	★	MNS0380LB	19.7	44.7	44.7	92.7	92	0.7	4	1
	10	□	MNS0380X10DB	38.7	52.7	55.7	103.7	103	0.7	4	1
	20	□	MNS0380X20DB	76.7	92.7	95.7	143.7	143	0.7	4	1
	30	□	MNS0380X30DB	114.7	132.7	135.7	183.7	183	0.7	4	1
3.9	3	□	MNS0390S-DIN	17.9	23.7	28.7	65.7	65	0.7	6	2
	3	□	MNS0390S-DIN-C	17.9	23.7	28.7	65.7	65	0.7	6	1
	5	□	MNS0390L-DIN	29.9	35.7	36.7	73.7	73	0.7	6	2
	5	□	MNS0390L-DIN-C	29.9	35.7	36.7	73.7	73	0.7	6	1
	8	□	MNS0390-L8C	31.9	44.7	47.7	84.7	84	0.7	6	1
	10	□	MNS0390-L10C	39.7	52.7	55.7	92.7	92	0.7	6	1
	12	□	MNS0390-L12C	47.5	60.7	63.7	100.7	100	0.7	6	1
	15	□	MNS0390-L15C	59.2	72.7	75.7	112.7	112	0.7	6	1
	20	□	MNS0390-L20C	78.7	92.7	95.7	132.7	132	0.7	6	1
	25	□	MNS0390-L25C	98.2	112.7	115.7	152.7	152	0.7	6	1
	30	□	MNS0390-L30C	117.7	132.7	135.7	172.7	172	0.7	6	1
	5	★	MNS0390LB	20.2	44.7	44.7	92.7	92	0.7	4	1
	10	★	MNS0390X10DB	39.7	52.7	55.7	103.7	103	0.7	4	1
	20	★	MNS0390X20DB	78.7	92.7	95.7	143.7	143	0.7	4	1
	30	★	MNS0390X30DB	117.7	132.7	135.7	183.7	183	0.7	4	1

M

BOHREN

DC	Bohrtiefe (mm)	TF15 (L/D)	Bestellnummer	Abmessungen (mm)							Typ
				LU	LCF	LH	OAL	LF	PL	DCONMS	
4.0	3	<input type="checkbox"/>	MNS0400S-DIN	17.7	23.7	28.7	65.7	65	0.7	6	2
	3	<input type="checkbox"/>	MNS0400S-DIN-C	17.7	23.7	28.7	65.7	65	0.7	6	1
	5	<input type="checkbox"/>	MNS0400L-DIN	29.7	35.7	36.7	73.7	73	0.7	6	2
	5	<input checked="" type="checkbox"/>	MNS0400L-DIN-C	29.7	35.7	36.7	73.7	73	0.7	6	1
	8	<input type="checkbox"/>	MNS0400-L8C	32.7	44.7	47.7	84.7	84	0.7	6	1
	10	<input type="checkbox"/>	MNS0400-L10C	40.7	52.7	55.7	92.7	92	0.7	6	1
	12	<input checked="" type="checkbox"/>	MNS0400-L12C	48.7	60.7	63.7	100.7	100	0.7	6	1
	15	<input type="checkbox"/>	MNS0400-L15C	60.7	72.7	75.7	112.7	112	0.7	6	1
	20	<input checked="" type="checkbox"/>	MNS0400-L20C	80.7	92.7	95.7	132.7	132	0.7	6	1
	25	<input checked="" type="checkbox"/>	MNS0400-L25C	100.7	112.7	115.7	152.7	152	0.7	6	1
	30	<input checked="" type="checkbox"/>	MNS0400-L30C	120.7	132.7	135.7	172.7	172	0.7	6	1
	5	<input checked="" type="checkbox"/>	MNS0400LB	20.7	44.7	44.7	92.7	92	0.7	4	1
	10	<input checked="" type="checkbox"/>	MNS0400X10DB	40.7	52.7	55.7	103.7	103	0.7	4	1
	20	<input checked="" type="checkbox"/>	MNS0400X20DB	80.7	92.7	95.7	143.7	143	0.7	4	1
30	<input checked="" type="checkbox"/>	MNS0400X30DB	120.7	132.7	135.7	183.7	183	0.7	4	1	
4.1	3	<input type="checkbox"/>	MNS0410S-DIN	17.6	23.7	28.7	65.7	65	0.7	6	2
	3	<input type="checkbox"/>	MNS0410S-DIN-C	17.6	23.7	28.7	65.7	65	0.7	6	1
	5	<input type="checkbox"/>	MNS0410L-DIN	29.6	35.7	36.7	73.7	73	0.7	6	2
	5	<input type="checkbox"/>	MNS0410L-DIN-C	29.6	35.7	36.7	73.7	73	0.7	6	1
	8	<input type="checkbox"/>	MNS0410-L8C	33.5	50.7	53.7	90.7	90	0.7	6	1
	10	<input type="checkbox"/>	MNS0410-L10C	41.7	59.7	62.7	99.7	99	0.7	6	1
	12	<input type="checkbox"/>	MNS0410-L12C	49.9	68.7	71.7	108.7	108	0.7	6	1
	15	<input type="checkbox"/>	MNS0410-L15C	62.2	81.7	84.7	121.7	121	0.7	6	1
	20	<input type="checkbox"/>	MNS0410-L20C	82.7	104.7	107.7	144.7	144	0.7	6	1
	25	<input type="checkbox"/>	MNS0410-L25C	103.2	126.7	129.7	166.7	166	0.7	6	1
	30	<input type="checkbox"/>	MNS0410-L30C	123.7	149.7	152.7	189.7	189	0.7	6	1
	5	<input checked="" type="checkbox"/>	MNS0410LB	21.2	50.7	50.7	100.7	100	0.7	5	1
	10	<input type="checkbox"/>	MNS0410X10DB	41.7	59.7	62.7	112.7	112	0.7	5	1
	20	<input type="checkbox"/>	MNS0410X20DB	82.7	104.7	107.7	157.7	157	0.7	5	1
30	<input type="checkbox"/>	MNS0410X30DB	123.7	149.7	152.7	202.7	202	0.7	5	1	
4.2	3	<input type="checkbox"/>	MNS0420S-DIN	17.5	23.8	28.8	65.8	65	0.8	6	2
	3	<input type="checkbox"/>	MNS0420S-DIN-C	17.5	23.8	28.8	65.8	65	0.8	6	1
	5	<input type="checkbox"/>	MNS0420L-DIN	29.5	35.8	36.8	73.8	73	0.8	6	2
	5	<input checked="" type="checkbox"/>	MNS0420L-DIN-C	29.5	35.8	36.8	73.8	73	0.8	6	1
	8	<input type="checkbox"/>	MNS0420-L8C	34.4	50.8	53.8	90.8	90	0.8	6	1
	10	<input type="checkbox"/>	MNS0420-L10C	42.8	59.8	62.8	99.8	99	0.8	6	1
	12	<input checked="" type="checkbox"/>	MNS0420-L12C	51.2	68.8	71.8	108.8	108	0.8	6	1
	15	<input type="checkbox"/>	MNS0420-L15C	63.8	81.8	84.8	121.8	121	0.8	6	1
	20	<input checked="" type="checkbox"/>	MNS0420-L20C	84.8	104.8	107.8	144.8	144	0.8	6	1
	25	<input type="checkbox"/>	MNS0420-L25C	105.8	126.8	129.8	166.8	166	0.8	6	1
	30	<input checked="" type="checkbox"/>	MNS0420-L30C	126.8	149.8	152.8	189.8	189	0.8	6	1
	5	<input checked="" type="checkbox"/>	MNS0420LB	21.8	50.8	50.8	100.8	100	0.8	5	1
	10	<input type="checkbox"/>	MNS0420X10DB	42.8	59.8	62.8	112.8	112	0.8	5	1
	20	<input type="checkbox"/>	MNS0420X20DB	84.8	104.8	107.8	157.8	157	0.8	5	1
30	<input type="checkbox"/>	MNS0420X30DB	126.8	149.8	152.8	202.8	202	0.8	5	1	

DC	Bohrtiefe (mm)	TF15 (L/D)	Bestellnummer	Abmessungen (mm)							Typ
				LU	LCF	LH	OAL	LF	PL	DCONMS	
4.3	3	<input type="checkbox"/>	MNS0430S-DIN	17.3	23.8	28.8	65.8	65	0.8	6	2
	3	<input type="checkbox"/>	MNS0430S-DIN-C	17.3	23.8	28.8	65.8	65	0.8	6	1
	5	<input type="checkbox"/>	MNS0430L-DIN	29.3	35.8	36.8	73.8	73	0.8	6	2
	5	<input type="checkbox"/>	MNS0430L-DIN-C	29.3	35.8	36.8	73.8	73	0.8	6	1
	8	<input type="checkbox"/>	MNS0430-L8C	35.2	50.8	53.8	90.8	90	0.8	6	1
	10	<input type="checkbox"/>	MNS0430-L10C	43.8	59.8	62.8	99.8	99	0.8	6	1
	12	<input type="checkbox"/>	MNS0430-L12C	52.4	68.8	71.8	108.8	108	0.8	6	1
	15	<input type="checkbox"/>	MNS0430-L15C	65.3	81.8	84.8	121.8	121	0.8	6	1
	20	<input type="checkbox"/>	MNS0430-L20C	86.8	104.8	107.8	144.8	144	0.8	6	1
	25	<input type="checkbox"/>	MNS0430-L25C	108.3	126.8	129.8	166.8	166	0.8	6	1
	30	<input type="checkbox"/>	MNS0430-L30C	129.8	149.8	152.8	189.8	189	0.8	6	1
	5	<input checked="" type="checkbox"/>	MNS0430LB	22.3	50.8	50.8	100.8	100	0.8	5	1
	10	<input type="checkbox"/>	MNS0430X10DB	43.8	59.8	62.8	112.8	112	0.8	5	1
	20	<input type="checkbox"/>	MNS0430X20DB	86.8	104.8	107.8	157.8	157	0.8	5	1
30	<input type="checkbox"/>	MNS0430X30DB	129.8	149.8	152.8	202.8	202	0.8	5	1	
4.4	3	<input type="checkbox"/>	MNS0440S-DIN	17.2	23.8	28.8	65.8	65	0.8	6	2
	3	<input type="checkbox"/>	MNS0440S-DIN-C	17.2	23.8	28.8	65.8	65	0.8	6	1
	5	<input type="checkbox"/>	MNS0440L-DIN	29.2	35.8	36.8	73.8	73	0.8	6	2
	5	<input type="checkbox"/>	MNS0440L-DIN-C	29.2	35.8	36.8	73.8	73	0.8	6	1
	8	<input type="checkbox"/>	MNS0440-L8C	36.0	50.8	53.8	90.8	90	0.8	6	1
	10	<input type="checkbox"/>	MNS0440-L10C	44.8	59.8	62.8	99.8	99	0.8	6	1
	12	<input type="checkbox"/>	MNS0440-L12C	53.6	68.8	71.8	108.8	108	0.8	6	1
	15	<input type="checkbox"/>	MNS0440-L15C	66.8	81.8	84.8	121.8	121	0.8	6	1
	20	<input type="checkbox"/>	MNS0440-L20C	88.8	104.8	107.8	144.8	144	0.8	6	1
	25	<input type="checkbox"/>	MNS0440-L25C	110.8	126.8	129.8	166.8	166	0.8	6	1
	30	<input type="checkbox"/>	MNS0440-L30C	132.8	149.8	152.8	189.8	189	0.8	6	1
	5	<input checked="" type="checkbox"/>	MNS0440LB	22.8	50.8	50.8	100.8	100	0.8	5	1
	10	<input type="checkbox"/>	MNS0440X10DB	44.8	59.8	62.8	112.8	112	0.8	5	1
	20	<input type="checkbox"/>	MNS0440X20DB	88.8	104.8	107.8	157.8	157	0.8	5	1
30	<input type="checkbox"/>	MNS0440X30DB	132.8	149.8	152.8	202.8	202	0.8	5	1	
4.5	3	<input type="checkbox"/>	MNS0450S-DIN	17.1	23.8	28.8	65.8	65	0.8	6	2
	3	<input type="checkbox"/>	MNS0450S-DIN-C	17.1	23.8	28.8	65.8	65	0.8	6	1
	5	<input type="checkbox"/>	MNS0450L-DIN	29.1	35.8	36.8	73.8	73	0.8	6	2
	5	<input checked="" type="checkbox"/>	MNS0450L-DIN-C	29.1	35.8	36.8	73.8	73	0.8	6	1
	8	<input type="checkbox"/>	MNS0450-L8C	36.8	50.8	53.8	90.8	90	0.8	6	1
	10	<input type="checkbox"/>	MNS0450-L10C	45.8	59.8	62.8	99.8	99	0.8	6	1
	12	<input checked="" type="checkbox"/>	MNS0450-L12C	54.8	68.8	71.8	108.8	108	0.8	6	1
	15	<input type="checkbox"/>	MNS0450-L15C	68.3	81.8	84.8	121.8	121	0.8	6	1
	20	<input checked="" type="checkbox"/>	MNS0450-L20C	90.8	104.8	107.8	144.8	144	0.8	6	1
	25	<input type="checkbox"/>	MNS0450-L25C	113.3	126.8	129.8	166.8	166	0.8	6	1
	30	<input checked="" type="checkbox"/>	MNS0450-L30C	135.8	149.8	152.8	189.8	189	0.8	6	1
	5	<input checked="" type="checkbox"/>	MNS0450LB	23.3	50.8	50.8	100.8	100	0.8	5	1
	10	<input type="checkbox"/>	MNS0450X10DB	45.8	59.8	62.8	112.8	112	0.8	5	1
	20	<input type="checkbox"/>	MNS0450X20DB	90.8	104.8	107.8	157.8	157	0.8	5	1
30	<input type="checkbox"/>	MNS0450X30DB	135.8	149.8	152.8	202.8	202	0.8	5	1	

Hinweis 1) Bei Bedarf von abweichenden Geometrien setzen Sie sich mit uns in Verbindung.  
(Andere Durchmesser und Längen können bestellt werden).

● : Lagerstandard. ★ : Lagerstandard in Japan.

□ : Herstellung nur auf Anfrage

DC	Bohrtiefe (mm)	Bohrtiefe (L/D)	TF15	Bestellnummer	Abmessungen (mm)							Typ
					LU	LCF	LH	OAL	LF	PL	DCONIMS	
4.6	3	□		MNS0460S-DIN	17.1	23.8	28.8	65.8	65	0.8	6	4
	3	□		MNS0460S-DIN-C	16.9	23.8	28.8	65.8	65	0.8	6	3
	5	□		MNS0460L-DIN	28.9	35.8	36.8	73.8	73	0.8	6	4
	5	□		MNS0460L-DIN-C	28.9	35.8	36.8	73.8	73	0.8	6	3
	8	□		MNS0460-L8C	37.6	55.8	58.8	95.8	95	0.8	6	3
	10	□		MNS0460-L10C	46.8	65.8	68.8	105.8	105	0.8	6	3
	12	□		MNS0460-L12C	56.0	75.8	78.8	115.8	115	0.8	6	3
	15	□		MNS0460-L15C	69.8	90.8	93.8	130.8	130	0.8	6	3
	20	□		MNS0460-L20C	92.8	115.8	118.8	155.8	155	0.8	6	3
	25	□		MNS0460-L25C	115.8	140.8	143.8	180.8	180	0.8	6	3
	30	□		MNS0460-L30C	138.8	165.8	168.8	205.8	205	0.8	6	3
	5	★		MNS0460LB	23.8	55.8	55.8	105.8	105	0.8	5	3
	10	□		MNS0460X10DB	46.8	65.8	68.8	118.8	118	0.8	5	3
	20	□		MNS0460X20DB	92.8	115.8	118.8	168.8	168	0.8	5	3
30	□		MNS0460X30DB	138.8	165.8	168.8	218.8	218	0.8	5	3	
4.65	3	□		MNS0465S-DIN	16.9	23.8	28.8	65.8	65	0.8	6	4
	3	□		MNS0465S-DIN-C	16.9	23.8	28.8	65.8	65	0.8	6	3
	5	□		MNS0465L-DIN	28.9	35.8	36.8	73.8	73	0.8	6	4
	5	●		MNS0465L-DIN-C	28.9	35.8	36.8	73.8	73	0.8	6	3
4.7	3	□		MNS0470S-DIN	16.8	23.9	28.9	65.9	65	0.9	6	4
	3	□		MNS0470S-DIN-C	16.8	23.9	28.9	65.9	65	0.9	6	3
	5	□		MNS0470L-DIN	28.8	35.9	36.9	73.9	73	0.9	6	4
	5	□		MNS0470L-DIN-C	28.8	35.9	36.9	73.9	73	0.9	6	3
	8	□		MNS0470-L8C	38.5	55.9	58.9	95.9	95	0.9	6	3
	10	□		MNS0470-L10C	47.9	65.9	68.9	105.9	105	0.9	6	3
	12	□		MNS0470-L12C	57.3	75.9	78.9	115.9	115	0.9	6	3
	15	□		MNS0470-L15C	71.4	90.9	93.9	130.9	130	0.9	6	3
	20	□		MNS0470-L20C	94.9	115.9	118.9	155.9	155	0.9	6	3
	25	□		MNS0470-L25C	118.4	140.9	143.9	180.9	180	0.9	6	3
	30	□		MNS0470-L30C	141.9	165.9	168.9	205.9	205	0.9	6	3
	5	★		MNS0470LB	24.4	55.9	55.9	105.9	105	0.9	5	3
	10	□		MNS0470X10DB	47.9	65.9	68.9	118.9	118	0.9	5	3
	20	□		MNS0470X20DB	94.9	115.9	118.9	168.9	168	0.9	5	3
30	□		MNS0470X30DB	141.9	165.9	168.9	218.9	218	0.9	5	3	
4.8	3	□		MNS0480S-DIN	20.7	27.9	28.9	65.9	65	0.9	6	4
	3	□		MNS0480S-DIN-C	20.7	27.9	28.9	65.9	65	0.9	6	3
	5	□		MNS0480L-DIN	36.7	43.9	44.9	81.9	81	0.9	6	4
	5	□		MNS0480L-DIN-C	36.7	43.9	44.9	81.9	81	0.9	6	3
	8	□		MNS0480-L8C	39.3	55.9	58.9	95.9	95	0.9	6	3
	10	□		MNS0480-L10C	48.9	65.9	68.9	105.9	105	0.9	6	3
	12	□		MNS0480-L12C	58.5	75.9	78.9	115.9	115	0.9	6	3
	15	□		MNS0480-L15C	72.9	90.9	93.9	130.9	130	0.9	6	3
	20	□		MNS0480-L20C	96.9	115.9	118.9	155.9	155	0.9	6	3
	25	□		MNS0480-L25C	120.9	140.9	143.9	180.9	180	0.9	6	3
	30	□		MNS0480-L30C	144.9	165.9	168.9	205.9	205	0.9	6	3
	5	★		MNS0480LB	24.9	55.9	55.9	105.9	105	0.9	5	3
	10	□		MNS0480X10DB	48.9	65.9	68.9	118.9	118	0.9	5	3
	20	□		MNS0480X20DB	96.9	115.9	118.9	168.9	168	0.9	5	3
30	□		MNS0480X30DB	144.9	165.9	168.9	218.9	218	0.9	5	3	

DC	Bohrtiefe (mm)	Bohrtiefe (L/D)	TF15	Bestellnummer	Abmessungen (mm)							Typ
					LU	LCF	LH	OAL	LF	PL	DCONIMS	
4.9	3	□		MNS0490S-DIN	20.5	27.9	28.9	65.9	65	0.9	6	4
	3	□		MNS0490S-DIN-C	20.5	27.9	28.9	65.9	65	0.9	6	3
	5	□		MNS0490L-DIN	36.5	43.9	44.9	81.9	81	0.9	6	4
	5	□		MNS0490L-DIN-C	36.5	43.9	44.9	81.9	81	0.9	6	3
	8	□		MNS0490-L8C	40.1	55.9	58.9	95.9	95	0.9	6	3
	10	□		MNS0490-L10C	49.9	65.9	68.9	105.9	105	0.9	6	3
	12	□		MNS0490-L12C	59.7	75.9	78.9	115.9	115	0.9	6	3
	15	□		MNS0490-L15C	74.4	90.9	93.9	130.9	130	0.9	6	3
	20	□		MNS0490-L20C	98.9	115.9	118.9	155.9	155	0.9	6	3
	25	□		MNS0490-L25C	123.4	140.9	143.9	180.9	180	0.9	6	3
	30	□		MNS0490-L30C	147.9	165.9	168.9	205.9	205	0.9	6	3
	5	★		MNS0490LB	25.4	55.9	55.9	105.9	105	0.9	5	3
	10	★		MNS0490X10DB	49.9	65.9	68.9	118.9	118	0.9	5	3
	20	★		MNS0490X20DB	98.9	115.9	118.9	168.9	168	0.9	5	3
30	★		MNS0490X30DB	147.9	165.9	168.9	218.9	218	0.9	5	3	
5.0	3	□		MNS0500S-DIN	20.4	27.9	28.9	65.9	65	0.9	6	4
	3	□		MNS0500S-DIN-C	20.4	27.9	28.9	65.9	65	0.9	6	3
	5	□		MNS0500L-DIN	36.4	43.9	44.9	81.9	81	0.9	6	4
	5	●		MNS0500L-DIN-C	36.4	43.9	44.9	81.9	81	0.9	6	3
	8	□		MNS0500-L8C	40.9	55.9	58.9	95.9	95	0.9	6	3
	10	□		MNS0500-L10C	50.9	65.9	68.9	105.9	105	0.9	6	3
	12	●		MNS0500-L12C	60.9	75.9	78.9	115.9	115	0.9	6	3
	15	□		MNS0500-L15C	75.9	90.9	93.9	130.9	130	0.9	6	3
	20	●		MNS0500-L20C	100.9	115.9	118.9	155.9	155	0.9	6	3
	25	□		MNS0500-L25C	125.9	140.9	143.9	180.9	180	0.9	6	3
	30	●		MNS0500-L30C	150.9	165.9	168.9	205.9	205	0.9	6	3
	5	★		MNS0500LB	25.9	44.9	44.9	100.9	100	0.9	6	3
	10	★		MNS0500X10DB	50.9	65.9	68.9	118.9	118	0.9	5	3
	20	★		MNS0500X20DB	100.9	115.9	118.9	168.9	168	0.9	5	3
30	★		MNS0500X30DB	150.9	165.9	168.9	218.9	218	0.9	5	3	
5.1	3	□		MNS0510S-DIN	20.3	27.9	28.9	65.9	65	0.9	6	4
	3	□		MNS0510S-DIN-C	20.3	27.9	28.9	65.9	65	0.9	6	3
	5	□		MNS0510L-DIN	36.3	43.9	44.9	81.9	81	0.9	6	4
	5	●		MNS0510L-DIN-C	36.3	43.9	44.9	81.9	81	0.9	6	3
	8	□		MNS0510-L8C	41.7	61.9	64.9	101.9	101	0.9	6	3
	10	□		MNS0510-L10C	51.9	72.9	75.9	112.9	112	0.9	6	3
	12	□		MNS0510-L12C	62.1	83.9	86.9	123.9	123	0.9	6	3
	15	□		MNS0510-L15C	77.4	99.9	102.9	139.9	139	0.9	6	3
	20	□		MNS0510-L20C	102.9	127.9	130.9	167.9	167	0.9	6	3
	25	□		MNS0510-L25C	128.4	154.9	157.9	194.9	194	0.9	6	3
	30	□		MNS0510-L30C	153.9	182.9	185.9	222.9	222	0.9	6	3
	5	★		MNS0510LB	26.4	44.9	44.9	100.9	100	0.9	6	3
	10	★		MNS0510X10DB	51.9	72.9	75.9	127.9	127	0.9	6	3
	20	★		MNS0510X20DB	102.9	127.9	130.9	182.9	182	0.9	6	3
30	★		MNS0510X30DB	153.9	182.9	185.9	237.9	237	0.9	6	3	

M

BOHREN

DC	Bohrtiefe (mm)	TF15	Bestellnummer	Abmessungen (mm)							Typ
				LU	LCF	LH	OAL	LF	PL	DCONMS	
5.2	3	<input type="checkbox"/>	MNS0520S-DIN	20.1	27.9	28.9	65.9	65	0.9	6	4
	3	<input type="checkbox"/>	MNS0520S-DIN-C	20.1	27.9	28.9	65.9	65	0.9	6	3
	5	<input type="checkbox"/>	MNS0520L-DIN	36.1	43.9	44.9	81.9	81	0.9	6	4
	5	<input type="checkbox"/>	MNS0520L-DIN-C	36.1	43.9	44.9	81.9	81	0.9	6	3
	8	<input type="checkbox"/>	MNS0520-L8C	42.5	61.9	64.9	101.9	101	0.9	6	3
	10	<input type="checkbox"/>	MNS0520-L10C	52.9	72.9	75.9	112.9	112	0.9	6	3
	12	<input type="checkbox"/>	MNS0520-L12C	63.3	83.9	86.9	123.9	123	0.9	6	3
	15	<input type="checkbox"/>	MNS0520-L15C	78.9	99.9	102.9	139.9	139	0.9	6	3
	20	<input type="checkbox"/>	MNS0520-L20C	104.9	127.9	130.9	167.9	167	0.9	6	3
	25	<input type="checkbox"/>	MNS0520-L25C	130.9	154.9	157.9	194.9	194	0.9	6	3
	30	<input type="checkbox"/>	MNS0520-L30C	156.9	182.9	185.9	222.9	222	0.9	6	3
	5	★	MNS0520LB	26.9	44.9	44.9	100.9	100	0.9	6	3
	10	<input type="checkbox"/>	MNS0520X10DB	52.9	72.9	75.9	127.9	127	0.9	6	3
20	<input type="checkbox"/>	MNS0520X20DB	104.9	127.9	130.9	182.9	182	0.9	6	3	
30	<input type="checkbox"/>	MNS0520X30DB	156.9	182.9	185.9	237.9	237	0.9	6	3	
5.3	3	<input type="checkbox"/>	MNS0530S-DIN	20.0	28.0	29.0	66.0	65	1.0	6	4
	3	<input type="checkbox"/>	MNS0530S-DIN-C	20.0	28.0	29.0	66.0	65	1.0	6	3
	5	<input type="checkbox"/>	MNS0530L-DIN	36.0	44.0	45.0	82.0	81	1.0	6	4
	5	<input type="checkbox"/>	MNS0530L-DIN-C	36.0	44.0	45.0	82.0	81	1.0	6	3
	8	<input type="checkbox"/>	MNS0530-L8C	43.4	62.0	65.0	102.0	101	1.0	6	3
	10	<input type="checkbox"/>	MNS0530-L10C	54.0	73.0	76.0	113.0	112	1.0	6	3
	12	<input type="checkbox"/>	MNS0530-L12C	64.6	84.0	87.0	124.0	123	1.0	6	3
	15	<input type="checkbox"/>	MNS0530-L15C	80.5	100.0	103.0	140.0	139	1.0	6	3
	20	<input type="checkbox"/>	MNS0530-L20C	107.0	128.0	131.0	168.0	167	1.0	6	3
	25	<input type="checkbox"/>	MNS0530-L25C	133.5	155.0	158.0	195.0	194	1.0	6	3
	30	<input type="checkbox"/>	MNS0530-L30C	160.0	183.0	186.0	223.0	222	1.0	6	3
	5	★	MNS0530LB	27.5	45.0	45.0	101.0	100	1.0	6	3
	10	<input type="checkbox"/>	MNS0530X10DB	54.0	73.0	76.0	128.0	127	1.0	6	3
20	<input type="checkbox"/>	MNS0530X20DB	107.0	128.0	131.0	183.0	182	1.0	6	3	
30	<input type="checkbox"/>	MNS0530X30DB	160.0	183.0	186.0	238.0	237	1.0	6	3	
5.4	3	<input type="checkbox"/>	MNS0540S-DIN	19.9	28.0	29.0	66.0	65	1.0	6	4
	3	<input type="checkbox"/>	MNS0540S-DIN-C	19.9	28.0	29.0	66.0	65	1.0	6	3
	5	<input type="checkbox"/>	MNS0540L-DIN	35.9	44.0	45.0	82.0	81	1.0	6	4
	5	<input type="checkbox"/>	MNS0540L-DIN-C	35.9	44.0	45.0	82.0	81	1.0	6	3
	8	<input type="checkbox"/>	MNS0540-L8C	44.2	62.0	65.0	102.0	101	1.0	6	3
	10	<input type="checkbox"/>	MNS0540-L10C	55.0	73.0	76.0	113.0	112	1.0	6	3
	12	<input type="checkbox"/>	MNS0540-L12C	65.8	84.0	87.0	124.0	123	1.0	6	3
	15	<input type="checkbox"/>	MNS0540-L15C	82.0	100.0	103.0	140.0	139	1.0	6	3
	20	<input type="checkbox"/>	MNS0540-L20C	109.0	128.0	131.0	168.0	167	1.0	6	3
	25	<input type="checkbox"/>	MNS0540-L25C	136.0	155.0	158.0	195.0	194	1.0	6	3
	30	<input type="checkbox"/>	MNS0540-L30C	163.0	183.0	186.0	223.0	222	1.0	6	3
	5	★	MNS0540LB	28.0	45.0	45.0	101.0	100	1.0	6	3
	10	<input type="checkbox"/>	MNS0540X10DB	55.0	73.0	76.0	128.0	127	1.0	6	3
20	<input type="checkbox"/>	MNS0540X20DB	109.0	128.0	131.0	183.0	182	1.0	6	3	
30	<input type="checkbox"/>	MNS0540X30DB	163.0	183.0	186.0	238.0	237	1.0	6	3	

DC	Bohrtiefe (mm)	TF15	Bestellnummer	Abmessungen (mm)							Typ
				LU	LCF	LH	OAL	LF	PL	DCONMS	
5.5	3	<input type="checkbox"/>	MNS0550S-DIN	19.8	28.0	29.0	66.0	65	1.0	6	4
	3	<input type="checkbox"/>	MNS0550S-DIN-C	19.8	28.0	29.0	66.0	65	1.0	6	3
	5	<input type="checkbox"/>	MNS0550L-DIN	35.8	44.0	45.0	82.0	81	1.0	6	4
	5	●	MNS0550L-DIN-C	35.8	44.0	45.0	82.0	81	1.0	6	3
	8	<input type="checkbox"/>	MNS0550-L8C	45.0	62.0	65.0	102.0	101	1.0	6	3
	10	<input type="checkbox"/>	MNS0550-L10C	56.0	73.0	76.0	113.0	112	1.0	6	3
	12	●	MNS0550-L12C	67.0	84.0	87.0	124.0	123	1.0	6	3
	15	<input type="checkbox"/>	MNS0550-L15C	83.5	100.0	103.0	140.0	139	1.0	6	3
	20	●	MNS0550-L20C	111.0	128.0	131.0	168.0	167	1.0	6	3
	25	<input type="checkbox"/>	MNS0550-L25C	138.5	155.0	158.0	195.0	194	1.0	6	3
	30	●	MNS0550-L30C	166.0	183.0	186.0	223.0	222	1.0	6	3
	5	★	MNS0550LB	28.5	45.0	45.0	101.0	100	1.0	6	3
	10	★	MNS0550X10DB	56.0	73.0	76.0	128.0	127	1.0	6	3
20	★	MNS0550X20DB	111.0	128.0	131.0	183.0	182	1.0	6	3	
30	★	MNS0550X30DB	166.0	183.0	186.0	238.0	237	1.0	6	3	
5.55	3	<input type="checkbox"/>	MNS0555S-DIN	19.7	28.0	29.0	66.0	65	1.0	6	4
	3	<input type="checkbox"/>	MNS0555S-DIN-C	19.7	28.0	29.0	66.0	65	1.0	6	3
	5	<input type="checkbox"/>	MNS0555L-DIN	35.7	44.0	45.0	82.0	81	1.0	6	4
	5	●	MNS0555L-DIN-C	35.7	44.0	45.0	82.0	81	1.0	6	3
	5	★	MNS0555LB	29.0	49.0	49.0	101.0	100	1.0	6	3
5.6	3	<input type="checkbox"/>	MNS0560S-DIN	19.6	28.0	29.0	66.0	65	1.0	6	4
	3	<input type="checkbox"/>	MNS0560S-DIN-C	19.6	28.0	29.0	66.0	65	1.0	6	3
	5	<input type="checkbox"/>	MNS0560L-DIN	35.6	44.0	45.0	82.0	81	1.0	6	4
	5	<input type="checkbox"/>	MNS0560L-DIN-C	35.6	44.0	45.0	82.0	81	1.0	6	3
	8	<input type="checkbox"/>	MNS0560-L8C	45.8	67.0	70.0	107.0	106	1.0	6	3
	10	<input type="checkbox"/>	MNS0560-L10C	57.0	79.0	82.0	119.0	118	1.0	6	3
	12	<input type="checkbox"/>	MNS0560-L12C	68.2	91.0	94.0	131.0	130	1.0	6	3
	15	<input type="checkbox"/>	MNS0560-L15C	85.0	109.0	112.0	149.0	148	1.0	6	3
	20	<input type="checkbox"/>	MNS0560-L20C	113.0	139.0	142.0	179.0	178	1.0	6	3
	25	<input type="checkbox"/>	MNS0560-L25C	141.0	169.0	172.0	209.0	208	1.0	6	3
	30	<input type="checkbox"/>	MNS0560-L30C	169.0	199.0	202.0	239.0	238	1.0	6	3
	10	<input type="checkbox"/>	MNS0560X10DB	57.0	79.0	82.0	134.0	133	1.0	6	3
	20	<input type="checkbox"/>	MNS0560X20DB	113.0	139.0	142.0	194.0	193	1.0	6	3
30	<input type="checkbox"/>	MNS0560X30DB	169.0	199.0	202.0	254.0	253	1.0	6	3	
5.7	3	<input type="checkbox"/>	MNS0570S-DIN	19.5	28.0	29.0	66.0	65	1.0	6	4
	3	<input type="checkbox"/>	MNS0570S-DIN-C	19.5	28.0	29.0	66.0	65	1.0	6	3
	5	<input type="checkbox"/>	MNS0570L-DIN	35.5	44.0	45.0	82.0	81	1.0	6	4
	5	<input type="checkbox"/>	MNS0570L-DIN-C	35.5	44.0	45.0	82.0	81	1.0	6	3
	8	<input type="checkbox"/>	MNS0570-L8C	46.6	67.0	70.0	107.0	106	1.0	6	3
	10	<input type="checkbox"/>	MNS0570-L10C	58.0	79.0	82.0	119.0	118	1.0	6	3
	12	<input type="checkbox"/>	MNS0570-L12C	69.4	91.0	94.0	131.0	130	1.0	6	3
	15	<input type="checkbox"/>	MNS0570-L15C	86.5	109.0	112.0	149.0	148	1.0	6	3
	20	<input type="checkbox"/>	MNS0570-L20C	115.0	139.0	142.0	179.0	178	1.0	6	3
	25	<input type="checkbox"/>	MNS0570-L25C	143.5	169.0	172.0	209.0	208	1.0	6	3
	30	<input type="checkbox"/>	MNS0570-L30C	172.0	199.0	202.0	239.0	238	1.0	6	3
	5	★	MNS0570LB	29.5	49.0	49.0	101.0	100	1.0	6	3
	10	<input type="checkbox"/>	MNS0570X10DB	58.0	79.0	82.0	134.0	133	1.0	6	3
20	<input type="checkbox"/>	MNS0570X20DB	115.0	139.0	142.0	194.0	193	1.0	6	3	
30	<input type="checkbox"/>	MNS0570X30DB	172.0	199.0	202.0	254.0	253	1.0	6	3	

Hinweis 1) Bei Bedarf von abweichenden Geometrien setzen Sie sich mit uns in Verbindung.  
(Andere Durchmesser und Längen können bestellt werden).

● : Lagerstandard. ★ : Lagerstandard in Japan.

□ : Herstellung nur auf Anfrage

DC	Bohrtiefe (mm)	TF/15 (L/D)	Bestellnummer	Abmessungen (mm)							Typ
				LU	LCF	LH	OAL	LF	PL	DCONIMS	
5.8	3	□	MNS0580S-DIN	19.4	28.1	29.1	66.1	65	1.1	6	4
	3	□	MNS0580S-DIN-C	19.4	28.1	29.1	66.1	65	1.1	6	3
	5	□	MNS0580L-DIN	35.4	44.1	45.1	82.1	81	1.1	6	4
	5	□	MNS0580L-DIN-C	35.4	44.1	45.1	82.1	81	1.1	6	3
	8	□	MNS0580-L8C	47.5	67.1	70.1	107.1	106	1.1	6	3
	10	□	MNS0580-L10C	59.1	79.1	82.1	119.1	118	1.1	6	3
	12	□	MNS0580-L12C	70.7	91.1	94.1	131.1	130	1.1	6	3
	15	□	MNS0580-L15C	88.1	109.1	112.1	149.1	148	1.1	6	3
	20	□	MNS0580-L20C	117.1	139.1	142.1	179.1	178	1.1	6	3
	25	□	MNS0580-L25C	146.1	169.1	172.1	209.1	208	1.1	6	3
	30	□	MNS0580-L30C	175.1	199.1	202.1	239.1	238	1.1	6	3
	5	★	MNS0580LB	30.1	49.1	49.1	101.1	100	1.1	6	3
	10	□	MNS0580X10DB	59.1	79.1	82.1	134.1	133	1.1	6	3
	20	□	MNS0580X20DB	117.1	139.1	142.1	194.1	193	1.1	6	3
30	□	MNS0580X30DB	175.1	199.1	202.1	254.1	253	1.1	6	3	
5.9	3	□	MNS0590S-DIN	19.2	28.1	29.1	66.1	65	1.1	6	4
	3	□	MNS0590S-DIN-C	19.2	28.1	29.1	66.1	65	1.1	6	3
	5	□	MNS0590L-DIN	35.2	44.1	45.1	82.1	81	1.1	6	4
	5	□	MNS0590L-DIN-C	35.2	44.1	45.1	82.1	81	1.1	6	3
	8	□	MNS0590-L8C	48.3	67.1	70.1	107.1	106	1.1	6	3
	10	□	MNS0590-L10C	60.1	79.1	82.1	119.1	118	1.1	6	3
	12	□	MNS0590-L12C	71.9	91.1	94.1	131.1	130	1.1	6	3
	15	□	MNS0590-L15C	89.6	109.1	112.1	149.1	148	1.1	6	3
	20	□	MNS0590-L20C	119.1	139.1	142.1	179.1	178	1.1	6	3
	25	□	MNS0590-L25C	148.6	169.1	172.1	209.1	208	1.1	6	3
	30	□	MNS0590-L30C	178.1	199.1	202.1	239.1	238	1.1	6	3
	5	★	MNS0590LB	30.6	49.1	49.1	101.1	100	1.1	6	3
	10	□	MNS0590X10DB	60.1	79.1	82.1	134.1	133	1.1	6	3
	20	□	MNS0590X20DB	119.1	139.1	142.1	194.1	193	1.1	6	3
30	□	MNS0590X30DB	178.1	199.1	202.1	254.1	253	1.1	6	3	
6.0	3	□	MNS0600S-DIN	19.1	28.1	29.1	66.1	65	1.1	6	4
	3	□	MNS0600S-DIN-C	19.1	28.1	29.1	66.1	65	1.1	6	3
	5	●	MNS0600L-DIN-C	35.1	44.1	45.1	82.1	81	1.1	6	3
	8	□	MNS0600-L8C	49.1	67.1	70.1	107.1	106	1.1	6	3
	10	□	MNS0600-L10C	61.1	79.1	82.1	119.1	118	1.1	6	3
	12	●	MNS0600-L12C	73.1	91.1	94.1	131.1	130	1.1	6	3
	15	□	MNS0600-L15C	91.1	109.1	112.1	149.1	148	1.1	6	3
	20	●	MNS0600-L20C	121.1	139.1	142.1	179.1	178	1.1	6	3
	25	□	MNS0600-L25C	151.1	169.1	172.1	209.1	208	1.1	6	3
	30	●	MNS0600-L30C	181.1	199.1	202.1	239.1	238	1.1	6	3
	5	★	MNS0600LB	31.1	49.1	49.1	101.1	100	1.1	6	3
	10	★	MNS0600X10DB	61.1	79.1	82.1	134.1	133	1.1	6	3
	20	★	MNS0600X20DB	121.1	139.1	142.1	194.1	193	1.1	6	3
	30	★	MNS0600X30DB	181.1	199.1	202.1	254.1	253	1.1	6	3

DC	Bohrtiefe (mm)	TF/15 (L/D)	Bestellnummer	Abmessungen (mm)							Typ
				LU	LCF	LH	OAL	LF	PL	DCONIMS	
6.1	3	□	MNS0610S-DIN	25.0	34.1	42.1	79.1	78	1.1	8	4
	3	□	MNS0610S-DIN-C	25.0	34.1	42.1	79.1	78	1.1	8	3
	5	□	MNS0610L-DIN	44.0	53.1	54.1	91.1	90	1.1	8	4
	5	□	MNS0610L-DIN-C	44.0	53.1	54.1	91.1	90	1.1	8	3
	8	□	MNS0610-L8C	49.9	73.1	76.1	113.1	112	1.1	8	3
	10	□	MNS0610-L10C	62.1	86.1	89.1	126.1	125	1.1	8	3
	12	□	MNS0610-L12C	74.3	99.1	102.1	139.1	138	1.1	8	3
	15	□	MNS0610-L15C	92.6	118.1	121.1	158.1	157	1.1	8	3
	20	□	MNS0610-L20C	123.1	151.1	154.1	191.1	190	1.1	8	3
	25	□	MNS0610-L25C	153.6	183.1	186.1	223.1	222	1.1	8	3
	30	□	MNS0610-L30C	184.1	216.1	219.1	256.1	255	1.1	8	3
	5	★	MNS0610LB	31.6	53.1	53.1	110.1	109	1.1	7	3
	10	★	MNS0610X10DB	62.1	86.1	89.1	142.1	141	1.1	7	3
	20	★	MNS0610X20DB	123.1	151.1	154.1	207.1	206	1.1	7	3
30	★	MNS0610X30DB	184.1	216.1	219.1	272.1	271	1.1	7	3	
6.2	3	□	MNS0620S-DIN	24.8	34.1	42.1	79.1	78	1.1	8	4
	3	□	MNS0620S-DIN-C	24.8	34.1	42.1	79.1	78	1.1	8	3
	5	□	MNS0620L-DIN	43.8	53.1	54.1	91.1	90	1.1	8	4
	5	□	MNS0620L-DIN-C	43.8	53.1	54.1	91.1	90	1.1	8	3
	8	□	MNS0620-L8C	50.7	73.1	76.1	113.1	112	1.1	8	3
	10	□	MNS0620-L10C	63.1	86.1	89.1	126.1	125	1.1	8	3
	12	□	MNS0620-L12C	75.5	99.1	102.1	139.1	138	1.1	8	3
	15	□	MNS0620-L15C	94.1	118.1	121.1	158.1	157	1.1	8	3
	20	□	MNS0620-L20C	125.1	151.1	154.1	191.1	190	1.1	8	3
	25	□	MNS0620-L25C	156.1	183.1	186.1	223.1	222	1.1	8	3
	30	□	MNS0620-L30C	187.1	216.1	219.1	256.1	255	1.1	8	3
	5	★	MNS0620LB	32.1	53.1	53.1	110.1	109	1.1	7	3
	10	□	MNS0620X10DB	63.1	86.1	89.1	142.1	141	1.1	7	3
	20	□	MNS0620X20DB	125.1	151.1	154.1	207.1	206	1.1	7	3
30	□	MNS0620X30DB	187.1	216.1	219.1	272.1	271	1.1	7	3	
6.3	3	□	MNS0630S-DIN	24.7	34.1	42.1	79.1	78	1.1	8	4
	3	□	MNS0630S-DIN-C	24.7	34.1	42.1	79.1	78	1.1	8	3
	5	□	MNS0630L-DIN	43.7	53.1	54.1	91.1	90	1.1	8	4
	5	□	MNS0630L-DIN-C	43.7	53.1	54.1	91.1	90	1.1	8	3
	8	□	MNS0630-L8C	51.5	73.1	76.1	113.1	112	1.1	8	3
	10	□	MNS0630-L10C	64.1	86.1	89.1	126.1	125	1.1	8	3
	12	□	MNS0630-L12C	76.7	99.1	102.1	139.1	138	1.1	8	3
	15	□	MNS0630-L15C	95.6	118.1	121.1	158.1	157	1.1	8	3
	20	□	MNS0630-L20C	127.1	151.1	154.1	191.1	190	1.1	8	3
	25	□	MNS0630-L25C	158.6	183.1	186.1	223.1	222	1.1	8	3
	30	□	MNS0630-L30C	190.1	216.1	219.1	256.1	255	1.1	8	3
	5	★	MNS0630LB	32.6	53.1	53.1	110.1	109	1.1	7	3
	10	□	MNS0630X10DB	64.1	86.1	89.1	142.1	141	1.1	7	3
	20	□	MNS0630X20DB	127.1	151.1	154.1	207.1	206	1.1	7	3
30	□	MNS0630X30DB	190.1	216.1	219.1	272.1	271	1.1	7	3	

M

BOHREN

DC	Bohrtiefe (mm)	Bohrtiefe (L/D)	TF15	Bestellnummer	Abmessungen (mm)								Typ
					LU	LCF	LH	OAL	LF	PL	DCONMS		
6.4	3	<input type="checkbox"/>		MNS0640S-DIN	24.6	34.2	42.2	79.2	78	1.2	8	4	
	3	<input type="checkbox"/>		MNS0640S-DIN-C	24.6	34.2	42.2	79.2	78	1.2	8	3	
	5	<input type="checkbox"/>		MNS0640L-DIN	43.6	53.2	54.2	91.2	90	1.2	8	4	
	5	<input type="checkbox"/>		MNS0640L-DIN-C	43.6	53.2	54.2	91.2	90	1.2	8	3	
	8	<input type="checkbox"/>		MNS0640-L8C	52.4	73.2	76.2	113.2	112	1.2	8	3	
	10	<input type="checkbox"/>		MNS0640-L10C	65.2	86.2	89.2	126.2	125	1.2	8	3	
	12	<input type="checkbox"/>		MNS0640-L12C	78.0	99.2	102.2	139.2	138	1.2	8	3	
	15	<input type="checkbox"/>		MNS0640-L15C	97.2	118.2	121.2	158.2	157	1.2	8	3	
	20	<input type="checkbox"/>		MNS0640-L20C	129.2	151.2	154.2	191.2	190	1.2	8	3	
	25	<input type="checkbox"/>		MNS0640-L25C	161.2	183.2	186.2	223.2	222	1.2	8	3	
	30	<input type="checkbox"/>		MNS0640-L30C	193.2	216.2	219.2	256.2	255	1.2	8	3	
	5	★		MNS0640LB	33.2	53.2	53.2	110.2	109	1.2	7	3	
	10	<input type="checkbox"/>		MNS0640X10DB	65.2	86.2	89.2	142.2	141	1.2	7	3	
20	<input type="checkbox"/>		MNS0640X20DB	129.2	151.2	154.2	207.2	206	1.2	7	3		
30	<input type="checkbox"/>		MNS0640X30DB	193.2	216.2	219.2	272.2	271	1.2	7	3		
6.5	3	<input type="checkbox"/>		MNS0650S-DIN	24.4	34.2	42.2	79.2	78	1.2	8	4	
	3	<input type="checkbox"/>		MNS0650S-DIN-C	24.4	34.2	42.2	79.2	78	1.2	8	3	
	5	<input type="checkbox"/>		MNS0650L-DIN	43.4	53.2	54.2	91.2	90	1.2	8	4	
	5	●		MNS0650L-DIN-C	43.4	53.2	54.2	91.2	90	1.2	8	3	
	8	<input type="checkbox"/>		MNS0650-L8C	53.2	73.2	76.2	113.2	112	1.2	8	3	
	10	<input type="checkbox"/>		MNS0650-L10C	66.2	86.2	89.2	126.2	125	1.2	8	3	
	12	●		MNS0650-L12C	79.2	99.2	102.2	139.2	138	1.2	8	3	
	15	<input type="checkbox"/>		MNS0650-L15C	98.7	118.2	121.2	158.2	157	1.2	8	3	
	20	●		MNS0650-L20C	131.2	151.2	154.2	191.2	190	1.2	8	3	
	25	<input type="checkbox"/>		MNS0650-L25C	163.7	183.2	186.2	223.2	222	1.2	8	3	
	30	●		MNS0650-L30C	196.2	216.2	219.2	256.2	255	1.2	8	3	
	5	★		MNS0650LB	33.7	53.2	53.2	110.2	109	1.2	7	3	
	10	★		MNS0650X10DB	66.2	86.2	89.2	142.2	141	1.2	7	3	
20	★		MNS0650X20DB	131.2	151.2	154.2	207.2	206	1.2	7	3		
30	★		MNS0650X30DB	196.2	216.2	219.2	272.2	271	1.2	7	3		
6.6	3	<input type="checkbox"/>		MNS0660S-DIN	24.3	34.2	42.2	79.2	78	1.2	8	4	
	3	<input type="checkbox"/>		MNS0660S-DIN-C	24.3	34.2	42.2	79.2	78	1.2	8	3	
	5	<input type="checkbox"/>		MNS0660L-DIN	43.3	53.2	54.2	91.2	90	1.2	8	4	
	5	<input type="checkbox"/>		MNS0660L-DIN-C	43.3	53.2	54.2	91.2	90	1.2	8	3	
	8	<input type="checkbox"/>		MNS0660-L8C	54.0	78.2	81.2	118.2	117	1.2	8	3	
	10	<input type="checkbox"/>		MNS0660-L10C	67.2	92.2	95.2	132.2	131	1.2	8	3	
	12	<input type="checkbox"/>		MNS0660-L12C	80.4	106.2	109.2	146.2	145	1.2	8	3	
	15	<input type="checkbox"/>		MNS0660-L15C	100.2	127.2	130.2	167.2	166	1.2	8	3	
	20	<input type="checkbox"/>		MNS0660-L20C	133.2	162.2	165.2	202.2	201	1.2	8	3	
	25	<input type="checkbox"/>		MNS0660-L25C	166.2	197.2	200.2	237.2	236	1.2	8	3	
	30	<input type="checkbox"/>		MNS0660-L30C	199.2	232.2	235.2	272.2	271	1.2	8	3	
	5	★		MNS0660LB	34.2	57.2	57.2	110.2	109	1.2	7	3	
	10	<input type="checkbox"/>		MNS0660X10DB	67.2	92.2	95.2	148.2	147	1.2	7	3	
20	<input type="checkbox"/>		MNS0660X20DB	133.2	162.2	165.2	218.2	217	1.2	7	3		
30	<input type="checkbox"/>		MNS0660X30DB	199.2	232.2	235.2	288.2	287	1.2	7	3		

DC	Bohrtiefe (mm)	Bohrtiefe (L/D)	TF15	Bestellnummer	Abmessungen (mm)								Typ
					LU	LCF	LH	OAL	LF	PL	DCONMS		
6.7	3	<input type="checkbox"/>		MNS0670S-DIN	24.2	34.2	42.2	79.2	78	1.2	8	4	
	3	<input type="checkbox"/>		MNS0670S-DIN-C	24.2	34.2	42.2	79.2	78	1.2	8	3	
	5	<input type="checkbox"/>		MNS0670L-DIN	43.2	53.2	54.2	91.2	90	1.2	8	4	
	5	<input type="checkbox"/>		MNS0670L-DIN-C	43.2	53.2	54.2	91.2	90	1.2	8	3	
	8	<input type="checkbox"/>		MNS0670-L8C	54.8	78.2	81.2	118.2	117	1.2	8	3	
	10	<input type="checkbox"/>		MNS0670-L10C	68.2	92.2	95.2	132.2	131	1.2	8	3	
	12	<input type="checkbox"/>		MNS0670-L12C	81.6	106.2	109.2	146.2	145	1.2	8	3	
	15	<input type="checkbox"/>		MNS0670-L15C	101.7	127.2	130.2	167.2	166	1.2	8	3	
	20	<input type="checkbox"/>		MNS0670-L20C	135.2	162.2	165.2	202.2	201	1.2	8	3	
	25	<input type="checkbox"/>		MNS0670-L25C	168.7	197.2	200.2	237.2	236	1.2	8	3	
	30	<input type="checkbox"/>		MNS0670-L30C	202.2	232.2	235.2	272.2	271	1.2	8	3	
	5	★		MNS0670LB	34.7	57.2	57.2	110.2	109	1.2	7	3	
	10	★		MNS0670X10DB	68.2	92.2	95.2	148.2	147	1.2	7	3	
20	★		MNS0670X20DB	135.2	162.2	165.2	218.2	217	1.2	7	3		
30	★		MNS0670X30DB	202.2	232.2	235.2	288.2	287	1.2	7	3		
6.8	3	<input type="checkbox"/>		MNS0680S-DIN	24.0	34.2	42.2	79.2	78	1.2	8	4	
	3	<input type="checkbox"/>		MNS0680S-DIN-C	24.0	34.2	42.2	79.2	78	1.2	8	3	
	5	<input type="checkbox"/>		MNS0680L-DIN	43.0	53.2	54.2	91.2	90	1.2	8	4	
	5	●		MNS0680L-DIN-C	43.0	53.2	54.2	91.2	90	1.2	8	3	
	8	<input type="checkbox"/>		MNS0680-L8C	55.6	78.2	81.2	118.2	117	1.2	8	3	
	10	<input type="checkbox"/>		MNS0680-L10C	69.2	92.2	95.2	132.2	131	1.2	8	3	
	12	●		MNS0680-L12C	82.8	106.2	109.2	146.2	145	1.2	8	3	
	15	<input type="checkbox"/>		MNS0680-L15C	103.2	127.2	130.2	167.2	166	1.2	8	3	
	20	●		MNS0680-L20C	137.2	162.2	165.2	202.2	201	1.2	8	3	
	25	<input type="checkbox"/>		MNS0680-L25C	171.2	197.2	200.2	237.2	236	1.2	8	3	
	30	●		MNS0680-L30C	205.2	232.2	235.2	272.2	271	1.2	8	3	
	5	★		MNS0680LB	35.2	57.2	57.2	110.2	109	1.2	7	3	
	10	<input type="checkbox"/>		MNS0680X10DB	69.2	92.2	95.2	148.2	147	1.2	7	3	
20	<input type="checkbox"/>		MNS0680X20DB	137.2	162.2	165.2	218.2	217	1.2	7	3		
30	<input type="checkbox"/>		MNS0680X30DB	205.2	232.2	235.2	288.2	287	1.2	7	3		
6.9	3	<input type="checkbox"/>		MNS0690S-DIN	23.9	34.3	42.3	79.3	78	1.3	8	4	
	3	<input type="checkbox"/>		MNS0690S-DIN-C	23.9	34.3	42.3	79.3	78	1.3	8	3	
	5	<input type="checkbox"/>		MNS0690L-DIN	42.9	53.3	54.3	91.3	90	1.3	8	4	
	5	<input type="checkbox"/>		MNS0690L-DIN-C	42.9	53.3	54.3	91.3	90	1.3	8	3	
	8	<input type="checkbox"/>		MNS0690-L8C	56.5	78.3	81.3	118.3	117	1.3	8	3	
	10	<input type="checkbox"/>		MNS0690-L10C	70.3	92.3	95.3	132.3	131	1.3	8	3	
	12	<input type="checkbox"/>		MNS0690-L12C	84.1	106.3	109.3	146.3	145	1.3	8	3	
	15	<input type="checkbox"/>		MNS0690-L15C	104.8	127.3	130.3	167.3	166	1.3	8	3	
	20	<input type="checkbox"/>		MNS0690-L20C	139.3	162.3	165.3	202.3	201	1.3	8	3	
	25	<input type="checkbox"/>		MNS0690-L25C	173.8	197.3	200.3	237.3	236	1.3	8	3	
	30	<input type="checkbox"/>		MNS0690-L30C	208.3	232.3	235.3	272.3	271	1.3	8	3	
	5	★		MNS0690LB	35.8	57.3	57.3	110.3	109	1.3	7	3	
	10	<input type="checkbox"/>		MNS0690X10DB	70.3	92.3	95.3	148.3	147	1.3	7	3	
20	<input type="checkbox"/>		MNS0690X20DB	139.3	162.3	165.3	218.3	217	1.3	7	3		
30	<input type="checkbox"/>		MNS0690X30DB	208.3	232.3	235.3	288.3	287	1.3	7	3		

Hinweis 1) Bei Bedarf von abweichenden Geometrien setzen Sie sich mit uns in Verbindung.

(Andere Durchmesser und Längen können bestellt werden).

● : Lagerstandard. ★ : Lagerstandard in Japan.

□ : Herstellung nur auf Anfrage

DC	Bohrtiefe (mm)	Bohrtiefe (L/D)	TF15	Bestellnummer	Abmessungen (mm)								Typ
					LU	LCF	LH	OAL	LF	PL	DCONMS		
7.0	3	□		MNS0700S-DIN	23.8	34.3	42.3	79.3	78	1.3	8	4	
	3	□		MNS0700S-DIN-C	23.8	34.3	42.3	79.3	78	1.3	8	3	
	5	□		MNS0700L-DIN	42.8	53.3	54.3	91.3	90	1.3	8	4	
	5	●		MNS0700L-DIN-C	42.8	53.3	54.3	91.3	90	1.3	8	3	
	8	□		MNS0700-L8C	57.3	78.3	81.3	118.3	117	1.3	8	3	
	10	□		MNS0700-L10C	71.3	92.3	95.3	132.3	131	1.3	8	3	
	12	●		MNS0700-L12C	85.3	106.3	109.3	146.3	145	1.3	8	3	
	15	□		MNS0700-L15C	106.3	127.3	130.3	167.3	166	1.3	8	3	
	20	●		MNS0700-L20C	141.3	162.3	165.3	202.3	201	1.3	8	3	
	25	□		MNS0700-L25C	176.3	197.3	200.3	237.3	236	1.3	8	3	
	30	●		MNS0700-L30C	211.3	232.3	235.3	272.3	271	1.3	8	3	
	5	★		MNS0700LB	36.3	57.3	57.3	110.3	109	1.3	7	3	
	10	★		MNS0700X10DB	71.3	92.3	95.3	148.3	147	1.3	7	3	
	20	★		MNS0700X20DB	141.3	162.3	165.3	218.3	217	1.3	7	3	
30	★		MNS0700X30DB	211.3	232.3	235.3	288.3	287	1.3	7	3		
7.1	3	□		MNS0710S-DIN	30.6	41.3	42.3	79.3	78	1.3	8	4	
	3	□		MNS0710S-DIN-C	30.6	41.3	42.3	79.3	78	1.3	8	3	
	5	□		MNS0710L-DIN	42.6	53.3	54.3	91.3	90	1.3	8	4	
	5	□		MNS0710L-DIN-C	42.6	53.3	54.3	91.3	90	1.3	8	3	
	8	□		MNS0710-L8C	58.1	84.3	87.3	124.3	123	1.3	8	3	
	10	□		MNS0710-L10C	72.3	99.3	102.3	139.3	138	1.3	8	3	
	12	□		MNS0710-L12C	86.5	114.3	117.3	154.3	153	1.3	8	3	
	15	□		MNS0710-L15C	107.8	136.3	139.3	176.3	175	1.3	8	3	
	20	□		MNS0710-L20C	143.3	174.3	177.3	214.3	213	1.3	8	3	
	25	□		MNS0710-L25C	178.8	211.3	214.3	251.3	250	1.3	8	3	
	30	□		MNS0710-L30C	214.3	249.3	252.3	289.3	288	1.3	8	3	
	5	★		MNS0710LB	36.8	61.3	65.3	119.3	118	1.3	8	3	
	10	□		MNS0710X10DB	72.3	99.3	102.3	156.3	155	1.3	8	3	
	20	□		MNS0710X20DB	143.3	174.3	177.3	231.3	230	1.3	8	3	
30	□		MNS0710X30DB	214.3	249.3	252.3	306.3	305	1.3	8	3		
7.2	3	□		MNS0720S-DIN	30.5	41.3	42.3	79.3	78	1.3	8	4	
	3	□		MNS0720S-DIN-C	30.5	41.3	42.3	79.3	78	1.3	8	3	
	5	□		MNS0720L-DIN	42.5	53.3	54.3	91.3	90	1.3	8	4	
	5	□		MNS0720L-DIN-C	42.5	53.3	54.3	91.3	90	1.3	8	3	
	8	□		MNS0720-L8C	58.9	84.3	87.3	124.3	123	1.3	8	3	
	10	□		MNS0720-L10C	73.3	99.3	102.3	139.3	138	1.3	8	3	
	12	□		MNS0720-L12C	87.7	114.3	117.3	154.3	153	1.3	8	3	
	15	□		MNS0720-L15C	109.3	136.3	139.3	176.3	175	1.3	8	3	
	20	□		MNS0720-L20C	145.3	174.3	177.3	214.3	213	1.3	8	3	
	25	□		MNS0720-L25C	181.3	211.3	214.3	251.3	250	1.3	8	3	
	30	□		MNS0720-L30C	217.3	249.3	252.3	289.3	288	1.3	8	3	
	5	★		MNS0720LB	37.3	61.3	65.3	119.3	118	1.3	8	3	
	10	★		MNS0720X10DB	73.3	99.3	102.3	156.3	155	1.3	8	3	
	20	★		MNS0720X20DB	145.3	174.3	177.3	231.3	230	1.3	8	3	
30	★		MNS0720X30DB	217.3	249.3	252.3	306.3	305	1.3	8	3		

DC	Bohrtiefe (mm)	Bohrtiefe (L/D)	TF15	Bestellnummer	Abmessungen (mm)								Typ
					LU	LCF	LH	OAL	LF	PL	DCONMS		
7.3	3	□		MNS0730S-DIN	30.4	41.3	42.3	79.3	78	1.3	8	4	
	3	□		MNS0730S-DIN-C	30.4	41.3	42.3	79.3	78	1.3	8	3	
	5	□		MNS0730L-DIN	42.4	53.3	54.3	91.3	90	1.3	8	4	
	5	□		MNS0730L-DIN-C	42.4	53.3	54.3	91.3	90	1.3	8	3	
	8	□		MNS0730-L8C	59.7	84.3	87.3	124.3	123	1.3	8	3	
	10	□		MNS0730-L10C	74.3	99.3	102.3	139.3	138	1.3	8	3	
	12	□		MNS0730-L12C	88.9	114.3	117.3	154.3	153	1.3	8	3	
	15	□		MNS0730-L15C	110.8	136.3	139.3	176.3	175	1.3	8	3	
	20	□		MNS0730-L20C	147.3	174.3	177.3	214.3	213	1.3	8	3	
	25	□		MNS0730-L25C	183.8	211.3	214.3	251.3	250	1.3	8	3	
	30	□		MNS0730-L30C	220.3	249.3	252.3	289.3	288	1.3	8	3	
	5	★		MNS0730LB	37.8	61.3	65.3	119.3	118	1.3	8	3	
	10	□		MNS0730X10DB	74.3	99.3	102.3	156.3	155	1.3	8	3	
	20	□		MNS0730X20DB	147.3	174.3	177.3	231.3	230	1.3	8	3	
30	□		MNS0730X30DB	220.3	249.3	252.3	306.3	305	1.3	8	3		
7.4	3	□		MNS0740S-DIN	30.2	41.3	42.3	79.3	78	1.3	8	4	
	3	□		MNS0740S-DIN-C	30.2	41.3	42.3	79.3	78	1.3	8	3	
	5	□		MNS0740L-DIN	42.2	53.3	54.3	91.3	90	1.3	8	4	
	5	□		MNS0740L-DIN-C	42.2	53.3	54.3	91.3	90	1.3	8	3	
	8	□		MNS0740-L8C	60.5	84.3	87.3	124.3	123	1.3	8	3	
	10	□		MNS0740-L10C	75.3	99.3	102.3	139.3	138	1.3	8	3	
	12	□		MNS0740-L12C	90.1	114.3	117.3	154.3	153	1.3	8	3	
	15	□		MNS0740-L15C	112.3	136.3	139.3	176.3	175	1.3	8	3	
	20	□		MNS0740-L20C	149.3	174.3	177.3	214.3	213	1.3	8	3	
	25	□		MNS0740-L25C	186.3	211.3	214.3	251.3	250	1.3	8	3	
	30	□		MNS0740-L30C	223.3	249.3	252.3	289.3	288	1.3	8	3	
	5	★		MNS0740LB	38.3	61.3	65.3	119.3	118	1.3	8	3	
	10	□		MNS0740X10DB	75.3	99.3	102.3	156.3	155	1.3	8	3	
	20	□		MNS0740X20DB	149.3	174.3	177.3	231.3	230	1.3	8	3	
30	□		MNS0740X30DB	223.3	249.3	252.3	306.3	305	1.3	8	3		
7.5	3	□		MNS0750S-DIN	30.1	41.4	42.4	79.4	78	1.4	8	4	
	3	□		MNS0750S-DIN-C	30.1	41.4	42.4	79.4	78	1.4	8	3	
	5	□		MNS0750L-DIN	42.1	53.4	54.4	91.4	90	1.4	8	4	
	5	●		MNS0750L-DIN-C	42.1	53.4	54.4	91.4	90	1.4	8	3	
	8	□		MNS0750-L8C	61.4	84.4	87.4	124.4	123	1.4	8	3	
	10	□		MNS0750-L10C	76.4	99.4	102.4	139.4	138	1.4	8	3	
	12	●		MNS0750-L12C	91.4	114.4	117.4	154.4	153	1.4	8	3	
	15	□		MNS0750-L15C	113.9	136.4	139.4	176.4	175	1.4	8	3	
	20	●		MNS0750-L20C	151.4	174.4	177.4	214.4	213	1.4	8	3	
	25	□		MNS0750-L25C	188.9	211.4	214.4	251.4	250	1.4	8	3	
	30	●		MNS0750-L30C	226.4	249.4	252.4	289.4	288	1.4	8	3	
	5	★		MNS0750LB	38.9	61.4	65.4	119.4	118	1.4	8	3	
	10	□		MNS0750X10DB	76.4	99.4	102.4	156.4	155	1.4	8	3	
	20	□		MNS0750X20DB	151.4	174.4	177.4	231.4	230	1.4	8	3	
30	□		MNS0750X30DB	226.4	249.4	252.4	306.4	305	1.4	8	3		

M

BOHREN

DC	Bohrtiefe (mm)	TF15 (L/D)	Bestellnummer	Abmessungen (mm)							Typ
				LU	LCF	LH	OAL	LF	PL	DCONMS	
7.6	3	<input type="checkbox"/>	MNS0760S-DIN	30.0	41.4	42.4	79.4	78	1.4	8	4
	3	<input type="checkbox"/>	MNS0760S-DIN-C	30.0	41.4	42.4	79.4	78	1.4	8	3
	5	<input type="checkbox"/>	MNS0760L-DIN	42.0	53.4	54.4	91.4	90	1.4	8	4
	5	<input type="checkbox"/>	MNS0760L-DIN-C	42.0	53.4	54.4	91.4	90	1.4	8	3
	8	<input type="checkbox"/>	MNS0760-L8C	62.2	89.4	92.4	129.4	128	1.4	8	3
	10	<input type="checkbox"/>	MNS0760-L10C	77.4	105.4	108.4	145.4	144	1.4	8	3
	12	<input type="checkbox"/>	MNS0760-L12C	92.6	121.4	124.4	161.4	160	1.4	8	3
	15	<input type="checkbox"/>	MNS0760-L15C	115.4	145.4	148.4	185.4	184	1.4	8	3
	20	<input type="checkbox"/>	MNS0760-L20C	153.4	185.4	188.4	225.4	224	1.4	8	3
	25	<input type="checkbox"/>	MNS0760-L25C	191.4	225.4	228.4	265.4	264	1.4	8	3
	30	<input type="checkbox"/>	MNS0760-L30C	229.4	265.4	268.4	305.4	304	1.4	8	3
	5	★	MNS0760LB	39.4	65.4	65.4	119.4	118	1.4	8	3
	10	<input type="checkbox"/>	MNS0760X10DB	77.4	105.4	108.4	162.4	161	1.4	8	3
	20	<input type="checkbox"/>	MNS0760X20DB	153.4	185.4	188.4	242.4	241	1.4	8	3
30	<input type="checkbox"/>	MNS0760X30DB	229.4	265.4	268.4	322.4	321	1.4	8	3	
7.7	3	<input type="checkbox"/>	MNS0770S-DIN	29.9	41.4	42.4	79.4	78	1.4	8	4
	3	<input type="checkbox"/>	MNS0770S-DIN-C	29.9	41.4	42.4	79.4	78	1.4	8	3
	5	<input type="checkbox"/>	MNS0770L-DIN	41.9	53.4	54.4	91.4	90	1.4	8	4
	5	<input type="checkbox"/>	MNS0770L-DIN-C	41.9	53.4	54.4	91.4	90	1.4	8	3
	8	<input type="checkbox"/>	MNS0770-L8C	63.0	89.4	92.4	129.4	128	1.4	8	3
	10	<input type="checkbox"/>	MNS0770-L10C	78.4	105.4	108.4	145.4	144	1.4	8	3
	12	<input type="checkbox"/>	MNS0770-L12C	93.8	121.4	124.4	161.4	160	1.4	8	3
	15	<input type="checkbox"/>	MNS0770-L15C	116.9	145.4	148.4	185.4	184	1.4	8	3
	20	<input type="checkbox"/>	MNS0770-L20C	155.4	185.4	188.4	225.4	224	1.4	8	3
	25	<input type="checkbox"/>	MNS0770-L25C	193.9	225.4	228.4	265.4	264	1.4	8	3
	30	<input type="checkbox"/>	MNS0770-L30C	232.4	265.4	268.4	305.4	304	1.4	8	3
	5	★	MNS0770LB	39.9	65.4	65.4	119.4	118	1.4	8	3
	10	<input type="checkbox"/>	MNS0770X10DB	78.4	105.4	108.4	162.4	161	1.4	8	3
	20	<input type="checkbox"/>	MNS0770X20DB	155.4	185.4	188.4	242.4	241	1.4	8	3
30	<input type="checkbox"/>	MNS0770X30DB	232.4	265.4	268.4	322.4	321	1.4	8	3	
7.8	3	<input type="checkbox"/>	MNS0780S-DIN	29.7	41.4	42.4	79.4	78	1.4	8	4
	3	<input type="checkbox"/>	MNS0780S-DIN-C	29.7	41.4	42.4	79.4	78	1.4	8	3
	5	<input type="checkbox"/>	MNS0780L-DIN	41.7	53.4	54.4	91.4	90	1.4	8	4
	5	<input type="checkbox"/>	MNS0780L-DIN-C	41.7	53.4	54.4	91.4	90	1.4	8	3
	8	<input type="checkbox"/>	MNS0780-L8C	63.8	89.4	92.4	129.4	128	1.4	8	3
	10	<input type="checkbox"/>	MNS0780-L10C	79.4	105.4	108.4	145.4	144	1.4	8	3
	12	<input type="checkbox"/>	MNS0780-L12C	95.0	121.4	124.4	161.4	160	1.4	8	3
	15	<input type="checkbox"/>	MNS0780-L15C	118.4	145.4	148.4	185.4	184	1.4	8	3
	20	<input type="checkbox"/>	MNS0780-L20C	157.4	185.4	188.4	225.4	224	1.4	8	3
	25	<input type="checkbox"/>	MNS0780-L25C	196.4	225.4	228.4	265.4	264	1.4	8	3
	30	<input type="checkbox"/>	MNS0780-L30C	235.4	265.4	268.4	305.4	304	1.4	8	3
	5	★	MNS0780LB	40.4	65.4	65.4	119.4	118	1.4	8	3
	10	★	MNS0780X10DB	79.4	105.4	108.4	162.4	161	1.4	8	3
	20	★	MNS0780X20DB	157.4	185.4	188.4	242.4	241	1.4	8	3
30	★	MNS0780X30DB	235.4	265.4	268.4	322.4	321	1.4	8	3	

DC	Bohrtiefe (mm)	TF15 (L/D)	Bestellnummer	Abmessungen (mm)							Typ
				LU	LCF	LH	OAL	LF	PL	DCONMS	
7.9	3	<input type="checkbox"/>	MNS0790S-DIN	29.6	41.4	42.4	79.4	78	1.4	8	4
	3	<input type="checkbox"/>	MNS0790S-DIN-C	29.6	41.4	42.4	79.4	78	1.4	8	3
	5	<input type="checkbox"/>	MNS0790L-DIN	41.6	53.4	54.4	91.4	90	1.4	8	4
	5	<input type="checkbox"/>	MNS0790L-DIN-C	41.6	53.4	54.4	91.4	90	1.4	8	3
	8	<input type="checkbox"/>	MNS0790-L8C	64.6	89.4	92.4	129.4	128	1.4	8	3
	10	<input type="checkbox"/>	MNS0790-L10C	80.4	105.4	108.4	145.4	144	1.4	8	3
	12	<input type="checkbox"/>	MNS0790-L12C	96.2	121.4	124.4	161.4	160	1.4	8	3
	15	<input type="checkbox"/>	MNS0790-L15C	119.9	145.4	148.4	185.4	184	1.4	8	3
	20	<input type="checkbox"/>	MNS0790-L20C	159.4	185.4	188.4	225.4	224	1.4	8	3
	25	<input type="checkbox"/>	MNS0790-L25C	198.9	225.4	228.4	265.4	264	1.4	8	3
	30	<input type="checkbox"/>	MNS0790-L30C	238.4	265.4	268.4	305.4	304	1.4	8	3
	5	★	MNS0790LB	40.9	65.4	65.4	119.4	118	1.4	8	3
	10	<input type="checkbox"/>	MNS0790X10DB	80.4	105.4	108.4	162.4	161	1.4	8	3
	20	<input type="checkbox"/>	MNS0790X20DB	159.4	185.4	188.4	242.4	241	1.4	8	3
30	<input type="checkbox"/>	MNS0790X30DB	238.4	265.4	268.4	322.4	321	1.4	8	3	
8.0	3	<input type="checkbox"/>	MNS0800S-DIN	29.5	41.5	42.5	79.5	78	1.5	8	4
	3	<input type="checkbox"/>	MNS0800S-DIN-C	29.5	41.5	42.5	79.5	78	1.5	8	3
	5	<input type="checkbox"/>	MNS0800L-DIN	41.5	53.5	54.5	91.5	90	1.5	8	4
	5	●	MNS0800L-DIN-C	41.5	53.5	54.5	91.5	90	1.5	8	3
	8	<input type="checkbox"/>	MNS0800-L8C	65.5	89.5	92.5	129.5	128	1.5	8	3
	10	<input type="checkbox"/>	MNS0800-L10C	81.5	105.5	108.5	145.5	144	1.5	8	3
	12	●	MNS0800-L12C	97.5	121.5	124.5	161.5	160	1.5	8	3
	15	<input type="checkbox"/>	MNS0800-L15C	121.5	145.5	148.5	185.5	184	1.5	8	3
	20	●	MNS0800-L20C	161.5	185.5	188.5	225.5	224	1.5	8	3
	25	<input type="checkbox"/>	MNS0800-L25C	201.5	225.5	228.5	265.5	264	1.5	8	3
	30	●	MNS0800-L30C	241.5	265.5	268.5	305.5	304	1.5	8	3
	5	★	MNS0800LB	41.5	65.5	65.5	119.5	118	1.5	8	3
	10	★	MNS0800X10DB	81.5	105.5	108.5	162.5	161	1.5	8	3
	20	★	MNS0800X20DB	161.5	185.5	188.5	242.5	241	1.5	8	3
30	★	MNS0800X30DB	241.5	265.5	268.5	322.5	321	1.5	8	3	
8.1	3	<input type="checkbox"/>	MNS0810S-DIN	34.3	46.5	47.5	88.5	87	1.5	10	4
	3	<input type="checkbox"/>	MNS0810S-DIN-C	34.3	46.5	47.5	88.5	87	1.5	10	3
	5	<input type="checkbox"/>	MNS0810L-DIN	48.3	60.5	61.5	102.5	101	1.5	10	4
	5	<input type="checkbox"/>	MNS0810L-DIN-C	48.3	60.5	61.5	102.5	101	1.5	10	3
	8	<input type="checkbox"/>	MNS0810-L8C	66.3	95.5	98.5	139.5	138	1.5	10	3
	10	<input type="checkbox"/>	MNS0810-L10C	82.5	112.5	115.5	156.5	155	1.5	10	3
	12	<input type="checkbox"/>	MNS0810-L12C	98.7	129.5	132.5	173.5	172	1.5	10	3
	15	<input type="checkbox"/>	MNS0810-L15C	123.0	154.5	157.5	198.5	197	1.5	10	3
	20	<input type="checkbox"/>	MNS0810-L20C	163.5	197.5	200.5	241.5	240	1.5	10	3
	25	<input type="checkbox"/>	MNS0810-L25C	204.0	239.5	242.5	283.5	282	1.5	10	3
	30	<input type="checkbox"/>	MNS0810-L30C	244.5	281.5	284.5	325.5	324	1.5	10	3
	5	★	MNS0810LB	42.0	69.5	73.5	128.5	127	1.5	9	3
	10	<input type="checkbox"/>	MNS0810X10DB	82.5	112.5	115.5	170.5	169	1.5	9	3
	20	<input type="checkbox"/>	MNS0810X20DB	163.5	197.5	200.5	255.5	254	1.5	9	3
30	<input type="checkbox"/>	MNS0810X30DB	244.5	282.5	285.5	340.5	339	1.5	9	3	

Hinweis 1) Bei Bedarf von abweichenden Geometrien setzen Sie sich mit uns in Verbindung.  
(Andere Durchmesser und Längen können bestellt werden).

● : Lagerstandard. ★ : Lagerstandard in Japan.

□ : Herstellung nur auf Anfrage



DC	Bohrtiefe (mm)	TF15 (L/D)	Bestellnummer	Abmessungen (mm)							Typ
				LU	LCF	LH	OAL	LF	PL	DCONIMS	
8.2	3	□	MNS0820S-DIN	34.2	46.5	47.5	88.5	87	1.5	10	4
	3	□	MNS0820S-DIN-C	34.2	46.5	47.5	88.5	87	1.5	10	3
	5	□	MNS0820L-DIN	48.2	60.5	61.5	102.5	101	1.5	10	4
	5	□	MNS0820L-DIN-C	48.2	60.5	61.5	102.5	101	1.5	10	3
	8	□	MNS0820-L8C	67.1	95.5	98.5	139.5	138	1.5	10	3
	5	★	MNS0820LB	42.5	69.5	73.5	128.5	127	1.5	9	3
	10	□	MNS0820X10DB	83.5	112.5	115.5	170.5	169	1.5	9	3
	20	□	MNS0820X20DB	165.5	197.5	200.5	255.5	254	1.5	9	3
	30	□	MNS0820X30DB	247.5	282.5	285.5	340.5	339	1.5	9	3
8.3	3	□	MNS0830S-DIN	34.1	46.5	47.5	88.5	87	1.5	10	4
	3	□	MNS0830S-DIN-C	34.1	46.5	47.5	88.5	87	1.5	10	3
	5	□	MNS0830L-DIN-C	48.1	60.5	61.5	102.5	101	1.5	10	3
	8	□	MNS0830-L8C	67.9	95.5	98.5	139.5	138	1.5	10	3
	10	□	MNS0830-L10C	84.5	112.5	115.5	156.5	155	1.5	10	3
	12	□	MNS0830-L12C	101.1	129.5	132.5	173.5	172	1.5	10	3
	15	□	MNS0830-L15C	126.0	154.5	157.5	198.5	197	1.5	10	3
	20	□	MNS0830-L20C	167.5	197.5	200.5	241.5	240	1.5	10	3
	25	□	MNS0830-L25C	209.0	239.5	242.5	283.5	282	1.5	10	3
	30	□	MNS0830-L30C	250.5	281.5	284.5	325.5	324	1.5	10	3
	5	★	MNS0830LB	43.0	69.5	73.5	128.5	127	1.5	9	3
	10	□	MNS0830X10DB	84.5	112.5	115.5	170.5	169	1.5	9	3
20	□	MNS0830X20DB	167.5	197.5	200.5	255.5	254	1.5	9	3	
30	□	MNS0830X30DB	250.5	282.5	285.5	340.5	339	1.5	9	3	
8.4	3	□	MNS0840S-DIN	33.9	46.5	47.5	88.5	87	1.5	10	4
	3	□	MNS0840S-DIN-C	33.9	46.5	47.5	88.5	87	1.5	10	3
	5	□	MNS0840L-DIN	47.9	60.5	61.5	102.5	101	1.5	10	4
	5	□	MNS0840L-DIN-C	47.9	60.5	61.5	102.5	101	1.5	10	3
	8	□	MNS0840-L8C	68.7	95.5	98.5	139.5	138	1.5	10	3
	10	□	MNS0840-L10C	85.5	112.5	115.5	156.5	155	1.5	10	3
	12	□	MNS0840-L12C	102.3	129.5	132.5	173.5	172	1.5	10	3
	15	□	MNS0840-L15C	127.5	154.5	157.5	198.5	197	1.5	10	3
	20	□	MNS0840-L20C	169.5	197.5	200.5	241.5	240	1.5	10	3
	25	□	MNS0840-L25C	211.5	239.5	242.5	283.5	282	1.5	10	3
	30	□	MNS0840-L30C	253.5	281.5	284.5	325.5	324	1.5	10	3
	5	★	MNS0840LB	43.5	69.5	73.5	128.5	127	1.5	9	3
10	□	MNS0840X10DB	85.5	112.5	115.5	170.5	169	1.5	9	3	
20	□	MNS0840X20DB	169.5	197.5	200.5	255.5	254	1.5	9	3	
30	□	MNS0840X30DB	253.5	282.5	285.5	340.5	339	1.5	9	3	

DC	Bohrtiefe (mm)	TF15 (L/D)	Bestellnummer	Abmessungen (mm)							Typ
				LU	LCF	LH	OAL	LF	PL	DCONIMS	
8.5	3	□	MNS0850S-DIN	33.8	46.5	47.5	88.5	87	1.5	10	4
	3	□	MNS0850S-DIN-C	33.8	46.5	47.5	88.5	87	1.5	10	3
	5	□	MNS0850L-DIN	47.8	60.5	61.5	102.5	101	1.5	10	4
	5	●	MNS0850L-DIN-C	47.8	60.5	61.5	102.5	101	1.5	10	3
	8	□	MNS0850-L8C	69.5	95.5	98.5	139.5	138	1.5	10	3
	10	□	MNS0850-L10C	86.5	112.5	115.5	156.5	155	1.5	10	3
	12	●	MNS0850-L12C	103.5	129.5	132.5	173.5	172	1.5	10	3
	15	□	MNS0850-L15C	129.0	154.5	157.5	198.5	197	1.5	10	3
	20	●	MNS0850-L20C	171.5	197.5	200.5	241.5	240	1.5	10	3
	25	□	MNS0850-L25C	214.0	239.5	242.5	283.5	282	1.5	10	3
	30	●	MNS0850-L30C	256.5	281.5	284.5	325.5	324	1.5	10	3
	5	★	MNS0850LB	44.0	69.5	73.5	128.5	127	1.5	9	3
10	□	MNS0850X10DB	86.5	112.5	115.5	170.5	169	1.5	9	3	
20	□	MNS0850X20DB	171.5	197.5	200.5	255.5	254	1.5	9	3	
30	□	MNS0850X30DB	256.5	282.5	285.5	340.5	339	1.5	9	3	
8.6	3	□	MNS0860S-DIN	33.7	46.6	47.6	88.6	87	1.6	10	4
	3	□	MNS0860S-DIN-C	33.7	46.6	47.6	88.6	87	1.6	10	3
	5	□	MNS0860L-DIN-C	47.7	60.6	61.6	102.6	101	1.6	10	3
	8	□	MNS0860-L8C	70.4	100.6	103.6	144.6	143	1.6	10	3
	10	□	MNS0860-L10C	87.6	118.6	121.6	162.6	161	1.6	10	3
	12	□	MNS0860-L12C	104.8	136.6	139.6	180.6	179	1.6	10	3
	15	□	MNS0860-L15C	130.6	163.6	166.6	207.6	206	1.6	10	3
	20	□	MNS0860-L20C	173.6	208.6	211.6	252.6	251	1.6	10	3
	25	□	MNS0860-L25C	216.6	253.6	256.6	297.6	296	1.6	10	3
	30	□	MNS0860-L30C	259.6	297.6	300.6	341.6	340	1.6	10	3
	5	★	MNS0860LB	44.6	73.6	73.6	128.6	127	1.6	9	3
	10	□	MNS0860X10DB	87.6	118.6	121.6	176.6	175	1.6	9	3
20	□	MNS0860X20DB	173.6	208.6	211.6	266.6	265	1.6	9	3	
30	□	MNS0860X30DB	259.6	298.6	301.6	356.6	355	1.6	9	3	
8.7	3	□	MNS0870S-DIN	33.5	46.6	47.6	88.6	87	1.6	10	4
	3	□	MNS0870S-DIN-C	33.5	46.6	47.6	88.6	87	1.6	10	3
	5	□	MNS0870L-DIN	47.5	60.6	61.6	102.6	101	1.6	10	4
	5	□	MNS0870L-DIN-C	47.5	60.6	61.6	102.6	101	1.6	10	3
	8	□	MNS0870-L8C	71.2	100.6	103.6	144.6	143	1.6	10	3
	10	□	MNS0870-L10C	88.6	118.6	121.6	162.6	161	1.6	10	3
	12	□	MNS0870-L12C	106.0	136.6	139.6	180.6	179	1.6	10	3
	15	□	MNS0870-L15C	132.1	163.6	166.6	207.6	206	1.6	10	3
	20	□	MNS0870-L20C	175.6	208.6	211.6	252.6	251	1.6	10	3
	25	□	MNS0870-L25C	219.1	253.6	256.6	297.6	296	1.6	10	3
	30	□	MNS0870-L30C	262.6	297.6	300.6	341.6	340	1.6	10	3
	5	★	MNS0870LB	45.1	73.6	73.6	128.6	127	1.6	9	3
10	□	MNS0870X10DB	88.6	118.6	121.6	176.6	175	1.6	9	3	
20	□	MNS0870X20DB	175.6	208.6	211.6	266.6	265	1.6	9	3	
30	□	MNS0870X30DB	262.6	298.6	301.6	356.6	355	1.6	9	3	

M

BOHREN

# MNS

BOHREN

M

DC	Bohrtiefe (mm)	Bohrtiefe (L/D)	TF15	Bestellnummer	Abmessungen (mm)							Typ
					LU	LCF	LH	OAL	LF	PL	DCONMS	
8.8	3		<input type="checkbox"/>	MNS0880S-DIN	33.4	46.6	47.6	88.6	87	1.6	10	4
	3		<input type="checkbox"/>	MNS0880S-DIN-C	33.4	46.6	47.6	88.6	87	1.6	10	3
	5		<input type="checkbox"/>	MNS0880L-DIN	47.4	60.6	61.6	102.6	101	1.6	10	4
	5		<input type="checkbox"/>	MNS0880L-DIN-C	47.4	60.6	61.6	102.6	101	1.6	10	3
	8		<input type="checkbox"/>	MNS0880-L8C	72.0	100.6	103.6	144.6	143	1.6	10	3
	10		<input type="checkbox"/>	MNS0880-L10C	89.6	118.6	121.6	162.6	161	1.6	10	3
	12		<input type="checkbox"/>	MNS0880-L12C	107.2	136.6	139.6	180.6	179	1.6	10	3
	15		<input type="checkbox"/>	MNS0880-L15C	133.6	163.6	166.6	207.6	206	1.6	10	3
	20		<input type="checkbox"/>	MNS0880-L20C	177.6	208.6	211.6	252.6	251	1.6	10	3
	25		<input type="checkbox"/>	MNS0880-L25C	221.6	253.6	256.6	297.6	296	1.6	10	3
	30		<input type="checkbox"/>	MNS0880-L30C	265.6	297.6	300.6	341.6	340	1.6	10	3
	5		<input checked="" type="checkbox"/>	MNS0880LB	45.6	73.6	73.6	128.6	127	1.6	9	3
	10		<input type="checkbox"/>	MNS0880X10DB	89.6	118.6	121.6	176.6	175	1.6	9	3
	20		<input type="checkbox"/>	MNS0880X20DB	177.6	208.6	211.6	266.6	265	1.6	9	3
30		<input type="checkbox"/>	MNS0880X30DB	265.6	298.6	301.6	356.6	355	1.6	9	3	
8.9	3		<input type="checkbox"/>	MNS0890S-DIN	33.3	46.6	47.6	88.6	87	1.6	10	4
	3		<input type="checkbox"/>	MNS0890S-DIN-C	33.3	46.6	47.6	88.6	87	1.6	10	3
	5		<input type="checkbox"/>	MNS0890L-DIN	47.3	60.6	61.6	102.6	101	1.6	10	4
	5		<input type="checkbox"/>	MNS0890L-DIN-C	47.3	60.6	61.6	102.6	101	1.6	10	3
	8		<input type="checkbox"/>	MNS0890-L8C	72.8	100.6	103.6	144.6	143	1.6	10	3
	10		<input type="checkbox"/>	MNS0890-L10C	90.6	118.6	121.6	162.6	161	1.6	10	3
	12		<input type="checkbox"/>	MNS0890-L12C	108.4	136.6	139.6	180.6	179	1.6	10	3
	15		<input type="checkbox"/>	MNS0890-L15C	135.1	163.6	166.6	207.6	206	1.6	10	3
	20		<input type="checkbox"/>	MNS0890-L20C	179.6	208.6	211.6	252.6	251	1.6	10	3
	25		<input type="checkbox"/>	MNS0890-L25C	224.1	253.6	256.6	297.6	296	1.6	10	3
	30		<input type="checkbox"/>	MNS0890-L30C	268.6	297.6	300.6	341.6	340	1.6	10	3
	5		<input checked="" type="checkbox"/>	MNS0890LB	46.1	73.6	73.6	128.6	127	1.6	9	3
	10		<input type="checkbox"/>	MNS0890X10DB	90.6	118.6	121.6	176.6	175	1.6	9	3
	20		<input type="checkbox"/>	MNS0890X20DB	179.6	208.6	211.6	266.6	265	1.6	9	3
30		<input type="checkbox"/>	MNS0890X30DB	268.6	298.6	301.6	356.6	355	1.6	9	3	
9.0	3		<input type="checkbox"/>	MNS0900S-DIN	33.1	46.6	47.6	88.6	87	1.6	10	4
	3		<input type="checkbox"/>	MNS0900S-DIN-C	33.1	46.6	47.6	88.6	87	1.6	10	3
	5		<input type="checkbox"/>	MNS0900L-DIN	47.1	60.6	61.6	102.6	101	1.6	10	4
	5		<input checked="" type="checkbox"/>	MNS0900L-DIN-C	47.1	60.6	61.6	102.6	101	1.6	10	3
	8		<input type="checkbox"/>	MNS0900-L8C	73.6	100.6	103.6	144.6	143	1.6	10	3
	10		<input type="checkbox"/>	MNS0900-L10C	91.6	118.6	121.6	162.6	161	1.6	10	3
	12		<input checked="" type="checkbox"/>	MNS0900-L12C	109.6	136.6	139.6	180.6	179	1.6	10	3
	15		<input type="checkbox"/>	MNS0900-L15C	136.6	163.6	166.6	207.6	206	1.6	10	3
	20		<input checked="" type="checkbox"/>	MNS0900-L20C	181.6	208.6	211.6	252.6	251	1.6	10	3
	25		<input type="checkbox"/>	MNS0900-L25C	226.6	253.6	256.6	297.6	296	1.6	10	3
	30		<input checked="" type="checkbox"/>	MNS0900-L30C	271.6	297.6	300.6	341.6	340	1.6	10	3
	5		<input checked="" type="checkbox"/>	MNS0900LB	46.6	73.6	73.6	128.6	127	1.6	9	3
	10		<input checked="" type="checkbox"/>	MNS0900X10DB	91.6	118.6	121.6	176.6	175	1.6	9	3
	20		<input checked="" type="checkbox"/>	MNS0900X20DB	181.6	208.6	211.6	266.6	265	1.6	9	3
30		<input checked="" type="checkbox"/>	MNS0900X30DB	271.6	298.6	301.6	356.6	355	1.6	9	3	

DC	Bohrtiefe (mm)	Bohrtiefe (L/D)	TF15	Bestellnummer	Abmessungen (mm)							Typ
					LU	LCF	LH	OAL	LF	PL	DCONMS	
9.1	3		<input type="checkbox"/>	MNS0910S-DIN	33.0	46.7	47.7	88.7	87	1.7	10	4
	3		<input type="checkbox"/>	MNS0910S-DIN-C	33.0	46.7	47.7	88.7	87	1.7	10	3
	5		<input type="checkbox"/>	MNS0910L-DIN	47.0	60.7	61.7	102.7	101	1.7	10	4
	5		<input type="checkbox"/>	MNS0910L-DIN-C	47.0	60.7	61.7	102.7	101	1.7	10	3
	8		<input type="checkbox"/>	MNS0910-L8C	74.5	106.7	109.7	150.7	149	1.7	10	3
	10		<input type="checkbox"/>	MNS0910-L10C	92.7	125.7	128.7	169.7	168	1.7	10	3
	12		<input type="checkbox"/>	MNS0910-L12C	110.9	144.7	147.7	188.7	187	1.7	10	3
	15		<input type="checkbox"/>	MNS0910-L15C	138.2	172.7	175.7	216.7	215	1.7	10	3
	20		<input type="checkbox"/>	MNS0910-L20C	183.7	220.7	223.7	264.7	263	1.7	10	3
	25		<input type="checkbox"/>	MNS0910-L25C	229.2	267.7	270.7	311.7	310	1.7	10	3
	30		<input type="checkbox"/>	MNS0910-L30C	274.7	315.7	318.7	359.7	358	1.7	10	3
	5		<input checked="" type="checkbox"/>	MNS0910LB	47.2	77.7	81.7	137.7	136	1.7	10	3
	10		<input type="checkbox"/>	MNS0910X10DB	92.7	125.7	128.7	183.7	182	1.7	10	3
	20		<input type="checkbox"/>	MNS0910X20DB	183.7	220.7	223.7	278.7	277	1.7	10	3
30		<input type="checkbox"/>	MNS0910X30DB	274.7	315.7	318.7	373.7	372	1.7	10	3	
9.2	3		<input type="checkbox"/>	MNS0920S-DIN	32.9	46.7	47.7	88.7	87	1.7	10	4
	3		<input type="checkbox"/>	MNS0920S-DIN-C	32.9	46.7	47.7	88.7	87	1.7	10	3
	5		<input type="checkbox"/>	MNS0920L-DIN	46.9	60.7	61.7	102.7	101	1.7	10	4
	5		<input type="checkbox"/>	MNS0920L-DIN-C	46.9	60.7	61.7	102.7	101	1.7	10	3
	8		<input type="checkbox"/>	MNS0920-L8C	75.3	106.7	109.7	150.7	149	1.7	10	3
	10		<input type="checkbox"/>	MNS0920-L10C	93.7	125.7	128.7	169.7	168	1.7	10	3
	12		<input type="checkbox"/>	MNS0920-L12C	112.1	144.7	147.7	188.7	187	1.7	10	3
	15		<input type="checkbox"/>	MNS0920-L15C	139.7	172.7	175.7	216.7	215	1.7	10	3
	20		<input type="checkbox"/>	MNS0920-L20C	185.7	220.7	223.7	264.7	263	1.7	10	3
	25		<input type="checkbox"/>	MNS0920-L25C	231.7	267.7	270.7	311.7	310	1.7	10	3
	30		<input type="checkbox"/>	MNS0920-L30C	277.7	315.7	318.7	359.7	358	1.7	10	3
	5		<input checked="" type="checkbox"/>	MNS0920LB	47.7	77.7	81.7	137.7	136	1.7	10	3
	10		<input type="checkbox"/>	MNS0920X10DB	93.7	125.7	128.7	183.7	182	1.7	10	3
	20		<input type="checkbox"/>	MNS0920X20DB	185.7	220.7	223.7	278.7	277	1.7	10	3
30		<input type="checkbox"/>	MNS0920X30DB	277.7	315.7	318.7	373.7	372	1.7	10	3	
9.3	3		<input type="checkbox"/>	MNS0930S-DIN	32.7	46.7	47.7	88.7	87	1.7	10	4
	3		<input type="checkbox"/>	MNS0930S-DIN-C	32.7	46.7	47.7	88.7	87	1.7	10	3
	5		<input type="checkbox"/>	MNS0930L-DIN	46.7	60.7	61.7	102.7	101	1.7	10	4
	5		<input type="checkbox"/>	MNS0930L-DIN-C	46.7	60.7	61.7	102.7	101	1.7	10	3
	8		<input type="checkbox"/>	MNS0930-L8C	76.1	106.7	109.7	150.7	149	1.7	10	3
	10		<input type="checkbox"/>	MNS0930-L10C	94.7	125.7	128.7	169.7	168	1.7	10	3
	12		<input type="checkbox"/>	MNS0930-L12C	113.3	144.7	147.7	188.7	187	1.7	10	3
	15		<input type="checkbox"/>	MNS0930-L15C	141.2	172.7	175.7	216.7	215	1.7	10	3
	20		<input type="checkbox"/>	MNS0930-L20C	187.7	220.7	223.7	264.7	263	1.7	10	3
	25		<input type="checkbox"/>	MNS0930-L25C	234.2	267.7	270.7	311.7	310	1.7	10	3
	30		<input type="checkbox"/>	MNS0930-L30C	280.7	315.7	318.7	359.7	358	1.7	10	3
	5		<input checked="" type="checkbox"/>	MNS0930LB	48.2	77.7	81.7	137.7	136	1.7	10	3
	10		<input type="checkbox"/>	MNS0930X10DB	94.7	125.7	128.7	183.7	182	1.7	10	3
	20		<input type="checkbox"/>	MNS0930X20DB	187.7	220.7	223.7	278.7	277	1.7	10	3
30		<input type="checkbox"/>	MNS0930X30DB	280.7	315.7	318.7	373.7	372	1.7	10	3	

Hinweis 1) Bei Bedarf von abweichenden Geometrien setzen Sie sich mit uns in Verbindung.

(Andere Durchmesser und Längen können bestellt werden).

● : Lagerstandard. ★ : Lagerstandard in Japan.

□ : Herstellung nur auf Anfrage

DC	Bohrtiefe (mm)	TF15 (L/D)	Bestellnummer	Abmessungen (mm)							Typ
				LU	LCF	LH	OAL	LF	PL	DCONMS	
9.4	3	□	MNS0940S-DIN	32.6	46.7	47.7	88.7	87	1.7	10	4
	3	□	MNS0940S-DIN-C	32.6	46.7	47.7	88.7	87	1.7	10	3
	5	□	MNS0940L-DIN	46.6	60.7	61.7	102.7	101	1.7	10	4
	5	□	MNS0940L-DIN-C	46.6	60.7	61.7	102.7	101	1.7	10	3
	8	□	MNS0940-L8C	76.9	106.7	109.7	150.7	149	1.7	10	3
	10	□	MNS0940-L10C	95.7	125.7	128.7	169.7	168	1.7	10	3
	12	□	MNS0940-L12C	114.5	144.7	147.7	188.7	187	1.7	10	3
	15	□	MNS0940-L15C	142.7	172.7	175.7	216.7	215	1.7	10	3
	20	□	MNS0940-L20C	189.7	220.7	223.7	264.7	263	1.7	10	3
	25	□	MNS0940-L25C	236.7	267.7	270.7	311.7	310	1.7	10	3
	30	□	MNS0940-L30C	283.7	315.7	318.7	359.7	358	1.7	10	3
	5	★	MNS0940LB	48.7	77.7	81.7	137.7	136	1.7	10	3
	10	□	MNS0940X10DB	95.7	125.7	128.7	183.7	182	1.7	10	3
	20	□	MNS0940X20DB	189.7	220.7	223.7	278.7	277	1.7	10	3
30	□	MNS0940X30DB	283.7	315.7	318.7	373.7	372	1.7	10	3	
9.5	3	□	MNS0950S-DIN	32.5	46.7	47.7	88.7	87	1.7	10	4
	3	□	MNS0950S-DIN-C	32.5	46.7	47.7	88.7	87	1.7	10	3
	5	□	MNS0950L-DIN	46.5	60.7	61.7	102.7	101	1.7	10	4
	5	●	MNS0950L-DIN-C	46.5	60.7	61.7	102.7	101	1.7	10	3
	8	□	MNS0950-L8C	77.7	106.7	109.7	150.7	149	1.7	10	3
	10	□	MNS0950-L10C	96.7	125.7	128.7	169.7	168	1.7	10	3
	12	●	MNS0950-L12C	115.7	144.7	147.7	188.7	187	1.7	10	3
	15	□	MNS0950-L15C	144.2	172.7	175.7	216.7	215	1.7	10	3
	20	●	MNS0950-L20C	191.7	220.7	223.7	264.7	263	1.7	10	3
	25	□	MNS0950-L25C	239.2	267.7	270.7	311.7	310	1.7	10	3
	30	●	MNS0950-L30C	286.7	315.7	318.7	359.7	358	1.7	10	3
	5	★	MNS0950LB	49.2	77.7	81.7	137.7	136	1.7	10	3
	10	□	MNS0950X10DB	96.7	125.7	128.7	183.7	182	1.7	10	3
	20	□	MNS0950X20DB	191.7	220.7	223.7	278.7	277	1.7	10	3
30	□	MNS0950X30DB	286.7	315.7	318.7	373.7	372	1.7	10	3	
9.6	3	□	MNS0960S-DIN	32.3	46.7	47.7	88.7	87	1.7	10	4
	3	□	MNS0960S-DIN-C	32.3	46.7	47.7	88.7	87	1.7	10	3
	5	□	MNS0960L-DIN	46.3	60.7	61.7	102.7	101	1.7	10	4
	5	□	MNS0960L-DIN-C	46.3	60.7	61.7	102.7	101	1.7	10	3
	8	□	MNS0960-L8C	78.5	111.7	114.7	155.7	154	1.7	10	3
	10	□	MNS0960-L10C	97.7	131.7	134.7	175.7	174	1.7	10	3
	12	□	MNS0960-L12C	116.9	151.7	154.7	195.7	194	1.7	10	3
	15	□	MNS0960-L15C	145.7	181.7	184.7	225.7	224	1.7	10	3
	20	□	MNS0960-L20C	193.7	231.7	234.7	275.7	274	1.7	10	3
	25	□	MNS0960-L25C	241.7	281.7	284.7	325.7	324	1.7	10	3
	30	□	MNS0960-L30C	289.7	331.7	334.7	375.7	374	1.7	10	3
	5	★	MNS0960LB	49.7	81.7	81.7	137.7	136	1.7	10	3
	10	□	MNS0960X10DB	97.7	131.7	134.7	189.7	188	1.7	10	3
	20	□	MNS0960X20DB	193.7	231.7	234.7	289.7	288	1.7	10	3
30	□	MNS0960X30DB	289.7	331.7	334.7	389.7	388	1.7	10	3	

DC	Bohrtiefe (mm)	TF15 (L/D)	Bestellnummer	Abmessungen (mm)							Typ
				LU	LCF	LH	OAL	LF	PL	DCONMS	
9.7	3	□	MNS0970S-DIN	32.2	46.8	47.8	88.8	87	1.8	10	4
	3	□	MNS0970S-DIN-C	32.2	46.8	47.8	88.8	87	1.8	10	3
	5	□	MNS0970L-DIN	46.2	60.8	61.8	102.8	101	1.8	10	4
	5	□	MNS0970L-DIN-C	46.2	60.8	61.8	102.8	101	1.8	10	3
	8	□	MNS0970-L8C	79.4	111.8	114.8	155.8	154	1.8	10	3
	10	□	MNS0970-L10C	98.8	131.8	134.8	175.8	174	1.8	10	3
	12	□	MNS0970-L12C	118.2	151.8	154.8	195.8	194	1.8	10	3
	15	□	MNS0970-L15C	147.3	181.8	184.8	225.8	224	1.8	10	3
	20	□	MNS0970-L20C	195.8	231.8	234.8	275.8	274	1.8	10	3
	25	□	MNS0970-L25C	244.3	281.8	284.8	325.8	324	1.8	10	3
	30	□	MNS0970-L30C	292.8	331.8	334.8	375.8	374	1.8	10	3
	5	★	MNS0970LB	50.3	81.8	81.8	137.8	136	1.8	10	3
	10	□	MNS0970X10DB	98.8	131.8	134.8	189.8	188	1.8	10	3
	20	□	MNS0970X20DB	195.8	231.8	234.8	289.8	288	1.8	10	3
30	□	MNS0970X30DB	292.8	331.8	334.8	389.8	388	1.8	10	3	
9.8	3	□	MNS0980S-DIN	32.1	46.8	47.8	88.8	87	1.8	10	4
	3	□	MNS0980S-DIN-C	32.1	46.8	47.8	88.8	87	1.8	10	3
	5	□	MNS0980L-DIN	46.1	60.8	61.8	102.8	101	1.8	10	4
	5	□	MNS0980L-DIN-C	46.1	60.8	61.8	102.8	101	1.8	10	3
	8	□	MNS0980-L8C	80.2	111.8	114.8	155.8	154	1.8	10	3
	10	□	MNS0980-L10C	99.8	131.8	134.8	175.8	174	1.8	10	3
	12	□	MNS0980-L12C	119.4	151.8	154.8	195.8	194	1.8	10	3
	15	□	MNS0980-L15C	148.8	181.8	184.8	225.8	224	1.8	10	3
	20	□	MNS0980-L20C	197.8	231.8	234.8	275.8	274	1.8	10	3
	25	□	MNS0980-L25C	246.8	281.8	284.8	325.8	324	1.8	10	3
	30	□	MNS0980-L30C	295.8	331.8	334.8	375.8	374	1.8	10	3
	5	★	MNS0980LB	50.8	81.8	81.8	137.8	136	1.8	10	3
	10	★	MNS0980X10DB	99.8	131.8	134.8	189.8	188	1.8	10	3
	20	★	MNS0980X20DB	197.8	231.8	234.8	289.8	288	1.8	10	3
30	★	MNS0980X30DB	295.8	331.8	334.8	389.8	388	1.8	10	3	
9.9	3	□	MNS0990S-DIN	32.0	46.8	47.8	88.8	87	1.8	10	4
	3	□	MNS0990S-DIN-C	32.0	46.8	47.8	88.8	87	1.8	10	3
	5	□	MNS0990L-DIN	46.0	60.8	61.8	102.8	101	1.8	10	4
	5	□	MNS0990L-DIN-C	46.0	60.8	61.8	102.8	101	1.8	10	3
	8	□	MNS0990-L8C	81.0	111.8	114.8	155.8	154	1.8	10	3
	10	□	MNS0990-L10C	100.8	131.8	134.8	175.8	174	1.8	10	3
	12	□	MNS0990-L12C	120.6	151.8	154.8	195.8	194	1.8	10	3
	15	□	MNS0990-L15C	150.3	181.8	184.8	225.8	224	1.8	10	3
	20	□	MNS0990-L20C	199.8	231.8	234.8	275.8	274	1.8	10	3
	25	□	MNS0990-L25C	249.3	281.8	284.8	325.8	324	1.8	10	3
	30	□	MNS0990-L30C	298.8	331.8	334.8	375.8	374	1.8	10	3
	5	★	MNS0990LB	51.3	81.8	81.8	137.8	136	1.8	10	3
	10	□	MNS0990X10DB	100.8	131.8	134.8	189.8	188	1.8	10	3
	20	□	MNS0990X20DB	199.8	231.8	234.8	289.8	288	1.8	10	3
30	□	MNS0990X30DB	298.8	331.8	334.8	389.8	388	1.8	10	3	

M

BOHREN

DC	Bohrtiefe (mm)	Bohrtiefe (L/D)	TF/15	Bestellnummer	Abmessungen (mm)							Typ
					LU	LCF	LH	OAL	LF	PL	DCONMS	
10.0	3		□	MNS1000S-DIN	31.8	46.8	47.8	88.8	87	1.8	10	4
	3		□	MNS1000S-DIN-C	31.8	46.8	47.8	88.8	87	1.8	10	3
	5		□	MNS1000L-DIN	45.8	60.8	61.8	102.8	101	1.8	10	4
	5		●	MNS1000L-DIN-C	45.8	60.8	61.8	102.8	101	1.8	10	3
	8		□	MNS1000-L8C	81.8	111.8	114.8	155.8	154	1.8	10	3
	10		□	MNS1000-L10C	101.8	131.8	134.8	175.8	174	1.8	10	3
	12		●	MNS1000-L12C	121.8	151.8	154.8	195.8	194	1.8	10	3
	15		□	MNS1000-L15C	151.8	181.8	184.8	225.8	224	1.8	10	3
	20		●	MNS1000-L20C	201.8	231.8	234.8	275.8	274	1.8	10	3
	25		□	MNS1000-L25C	251.8	281.8	284.8	325.8	324	1.8	10	3
	30		●	MNS1000-L30C	301.8	331.8	334.8	375.8	374	1.8	10	3
	5		★	MNS1000LB	51.8	81.8	81.8	137.8	136	1.8	10	3
	10		★	MNS1000X10DB	101.8	131.8	134.8	189.8	188	1.8	10	3
	20		★	MNS1000X20DB	201.8	231.8	234.8	289.8	288	1.8	10	3
30		★	MNS1000X30DB	301.8	331.8	334.8	389.8	388	1.8	10	3	
10.1	3		□	MNS1010S-DIN	39.7	54.8	55.8	101.8	100	1.8	12	4
	3		□	MNS1010S-DIN-C	39.7	54.8	55.8	101.8	100	1.8	12	3
	5		□	MNS1010L-DIN	55.7	70.8	71.8	117.8	116	1.8	12	4
	5		□	MNS1010L-DIN-C	55.7	70.8	71.8	117.8	116	1.8	12	3
	8		□	MNS1010-L8C	82.6	117.8	120.8	166.8	165	1.8	12	3
	10		□	MNS1010-L10C	102.8	138.8	141.8	187.8	186	1.8	12	3
	12		□	MNS1010-L12C	123.0	159.8	162.8	208.8	207	1.8	12	3
	15		□	MNS1010-L15C	153.3	190.8	193.8	239.8	238	1.8	12	3
	20		□	MNS1010-L20C	203.8	243.8	246.8	292.8	291	1.8	12	3
	25		□	MNS1010-L25C	254.3	295.8	298.8	344.8	343	1.8	12	3
	5		★	MNS1010LB	52.3	85.8	89.8	150.8	149	1.8	11	3
	10		□	MNS1010X10DB	102.8	138.8	141.8	202.8	201	1.8	11	3
	20		□	MNS1010X20DB	203.8	243.8	246.8	307.8	306	1.8	11	3
	10.2	3		□	MNS1020S-DIN	39.6	54.9	55.9	101.9	100	1.9	12
3			□	MNS1020S-DIN-C	39.6	54.9	55.9	101.9	100	1.9	12	3
5			□	MNS1020L-DIN	55.6	70.9	71.9	117.9	116	1.9	12	4
5			□	MNS1020L-DIN-C	55.6	70.9	71.9	117.9	116	1.9	12	3
8			□	MNS1020-L8C	83.5	117.9	120.9	166.9	165	1.9	12	3
10			□	MNS1020-L10C	103.9	138.9	141.9	187.9	186	1.9	12	3
12			□	MNS1020-L12C	124.3	159.9	162.9	208.9	207	1.9	12	3
15			□	MNS1020-L15C	154.9	190.9	193.9	239.9	238	1.9	12	3
20			□	MNS1020-L20C	205.9	243.9	246.9	292.9	291	1.9	12	3
25			□	MNS1020-L25C	256.9	295.9	298.9	344.9	343	1.9	12	3
5			★	MNS1020LB	52.9	85.9	89.9	150.9	149	1.9	11	3
10			□	MNS1020X10DB	103.9	138.9	141.9	202.9	201	1.9	11	3
20			□	MNS1020X20DB	205.9	243.9	246.9	307.9	306	1.9	11	3
10.3		3		□	MNS1030S-DIN	39.4	54.9	55.9	101.9	100	1.9	12
	3		□	MNS1030S-DIN-C	39.4	54.9	55.9	101.9	100	1.9	12	3
	5		□	MNS1030L-DIN	55.4	70.9	71.9	117.9	116	1.9	12	4
	5		□	MNS1030L-DIN-C	55.4	70.9	71.9	117.9	116	1.9	12	3
	8		□	MNS1030-L8C	84.3	117.9	120.9	166.9	165	1.9	12	3
	10		□	MNS1030-L10C	104.9	138.9	141.9	187.9	186	1.9	12	3
	12		□	MNS1030-L12C	125.5	159.9	162.9	208.9	207	1.9	12	3

DC	Bohrtiefe (mm)	Bohrtiefe (L/D)	TF/15	Bestellnummer	Abmessungen (mm)							Typ
					LU	LCF	LH	OAL	LF	PL	DCONMS	
10.3	15		□	MNS1030-L15C	156.4	190.9	193.9	239.9	238	1.9	12	3
	20		□	MNS1030-L20C	207.9	243.9	246.9	292.9	291	1.9	12	3
	25		□	MNS1030-L25C	259.4	295.9	298.9	344.9	343	1.9	12	3
	5		★	MNS1030LB	53.4	85.9	89.9	150.9	149	1.9	11	3
	10		□	MNS1030X10DB	104.9	138.9	141.9	202.9	201	1.9	11	3
	20		□	MNS1030X20DB	207.9	243.9	246.9	307.9	306	1.9	11	3
10.4	3		□	MNS1040S-DIN	39.3	54.9	55.9	101.9	100	1.9	12	4
	3		□	MNS1040S-DIN-C	39.3	54.9	55.9	101.9	100	1.9	12	3
	5		□	MNS1040L-DIN	55.3	70.9	71.9	117.9	116	1.9	12	4
	5		□	MNS1040L-DIN-C	55.3	70.9	71.9	117.9	116	1.9	12	3
	8		□	MNS1040-L8C	85.1	117.9	120.9	166.9	165	1.9	12	3
	10		□	MNS1040-L10C	105.9	138.9	141.9	187.9	186	1.9	12	3
	12		□	MNS1040-L12C	126.7	159.9	162.9	208.9	207	1.9	12	3
	15		□	MNS1040-L15C	157.9	190.9	193.9	239.9	238	1.9	12	3
	20		□	MNS1040-L20C	209.9	243.9	246.9	292.9	291	1.9	12	3
	25		□	MNS1040-L25C	261.9	295.9	298.9	344.9	343	1.9	12	3
5		★	MNS1040LB	53.9	85.9	89.9	150.9	149	1.9	11	3	
10		□	MNS1040X10DB	105.9	138.9	141.9	202.9	201	1.9	11	3	
20		□	MNS1040X20DB	209.9	243.9	246.9	307.9	306	1.9	11	3	
10.5	3		□	MNS1050S-DIN	39.2	54.9	55.9	101.9	100	1.9	12	4
	3		□	MNS1050S-DIN-C	39.2	54.9	55.9	101.9	100	1.9	12	3
	5		□	MNS1050L-DIN	55.2	70.9	71.9	117.9	116	1.9	12	4
	5		●	MNS1050L-DIN-C	55.2	70.9	71.9	117.9	116	1.9	12	3
	8		□	MNS1050-L8C	85.9	117.9	120.9	166.9	165	1.9	12	3
	10		□	MNS1050-L10C	106.9	138.9	141.9	187.9	186	1.9	12	3
	12		●	MNS1050-L12C	127.9	159.9	162.9	208.9	207	1.9	12	3
	15		□	MNS1050-L15C	159.4	190.9	193.9	239.9	238	1.9	12	3
	20		●	MNS1050-L20C	211.9	243.9	246.9	292.9	291	1.9	12	3
	25		□	MNS1050-L25C	264.4	295.9	298.9	344.9	343	1.9	12	3
5		★	MNS1050LB	54.4	85.9	89.9	150.9	149	1.9	11	3	
10		★	MNS1050X10DB	106.9	138.9	141.9	202.9	201	1.9	11	3	
20		★	MNS1050X20DB	211.9	243.9	246.9	307.9	306	1.9	11	3	
10.6	3		□	MNS1060S-DIN	39.0	54.9	55.9	101.9	100	1.9	12	4
	3		□	MNS1060S-DIN-C	39.0	54.9	55.9	101.9	100	1.9	12	3
	5		□	MNS1060L-DIN	55.0	70.9	71.9	117.9	116	1.9	12	4
	5		□	MNS1060L-DIN-C	55.0	70.9	71.9	117.9	116	1.9	12	3
	8		□	MNS1060-L8C	86.7	122.9	125.9	171.9	170	1.9	12	3
	10		□	MNS1060-L10C	107.9	144.9	147.9	193.9	192	1.9	12	3
	12		□	MNS1060-L12C	129.1	166.9	169.9	215.9	214	1.9	12	3
	15		□	MNS1060-L15C	160.9	199.9	202.9	248.9	247	1.9	12	3
	20		□	MNS1060-L20C	213.9	254.9	257.9	303.9	302	1.9	12	3
	25		□	MNS1060-L25C	266.9	309.9	312.9	358.9	357	1.9	12	3
5		★	MNS1060LB	54.9	89.9	89.9	150.9	149	1.9	11	3	
10		□	MNS1060X10DB	107.9	144.9	147.9	208.9	207	1.9	11	3	
20		□	MNS1060X20DB	213.9	254.9	257.9	318.9	317	1.9	11	3	

Hinweis 1) Bei Bedarf von abweichenden Geometrien setzen Sie sich mit uns in Verbindung.  
(Andere Durchmesser und Längen können bestellt werden).

● : Lagerstandard. ★ : Lagerstandard in Japan.

□ : Herstellung nur auf Anfrage

DC	Bohrtiefe (mm)	TF/15 (L/D)	Bestellnummer	Abmessungen (mm)							Typ
				LU	LCF	LH	OAL	LF	PL	DCONMS	
10.7	3	□	MNS1070S-DIN	38.9	54.9	55.9	101.9	100	1.9	12	4
	3	□	MNS1070S-DIN-C	38.9	54.9	55.9	101.9	100	1.9	12	3
	5	□	MNS1070L-DIN	54.9	70.9	71.9	117.9	116	1.9	12	4
	5	□	MNS1070L-DIN-C	54.9	70.9	71.9	117.9	116	1.9	12	3
	8	□	MNS1070-L8C	87.5	122.9	125.9	171.9	170	1.9	12	3
	10	□	MNS1070-L10C	108.9	144.9	147.9	193.9	192	1.9	12	3
	12	□	MNS1070-L12C	130.3	166.9	169.9	215.9	214	1.9	12	3
	15	□	MNS1070-L15C	162.4	199.9	202.9	248.9	247	1.9	12	3
	20	□	MNS1070-L20C	215.9	254.9	257.9	303.9	302	1.9	12	3
	25	□	MNS1070-L25C	269.4	309.9	312.9	358.9	357	1.9	12	3
	5	★	MNS1070LB	55.4	89.9	89.9	150.9	149	1.9	11	3
	10	□	MNS1070X10DB	108.9	144.9	147.9	208.9	207	1.9	11	3
20	□	MNS1070X20DB	215.9	254.9	257.9	318.9	317	1.9	11	3	
10.8	3	□	MNS1080S-DIN	38.8	55.0	56.0	102.0	100	2.0	12	4
	3	□	MNS1080S-DIN-C	38.8	55.0	56.0	102.0	100	2.0	12	3
	5	□	MNS1080L-DIN	54.8	71.0	72.0	118.0	116	2.0	12	4
	5	□	MNS1080L-DIN-C	54.8	71.0	72.0	118.0	116	2.0	12	3
	8	□	MNS1080-L8C	88.4	123.0	126.0	172.0	170	2.0	12	3
	10	□	MNS1080-L10C	110.0	145.0	148.0	194.0	192	2.0	12	3
	12	□	MNS1080-L12C	131.6	167.0	170.0	216.0	214	2.0	12	3
	15	□	MNS1080-L15C	164.0	200.0	203.0	249.0	247	2.0	12	3
	20	□	MNS1080-L20C	218.0	255.0	258.0	304.0	302	2.0	12	3
	25	□	MNS1080-L25C	272.0	310.0	313.0	359.0	357	2.0	12	3
	5	★	MNS1080LB	56.0	90.0	90.0	151.0	149	2.0	11	3
	10	□	MNS1080X10DB	110.0	145.0	148.0	209.0	207	2.0	11	3
20	□	MNS1080X20DB	218.0	255.0	258.0	319.0	317	2.0	11	3	
10.9	3	□	MNS1090S-DIN	38.6	55.0	56.0	102.0	100	2.0	12	4
	3	□	MNS1090S-DIN-C	38.6	55.0	56.0	102.0	100	2.0	12	3
	5	□	MNS1090L-DIN	54.6	71.0	72.0	118.0	116	2.0	12	4
	5	□	MNS1090L-DIN-C	54.6	71.0	72.0	118.0	116	2.0	12	3
	8	□	MNS1090-L8C	89.2	123.0	126.0	172.0	170	2.0	12	3
	10	□	MNS1090-L10C	111.0	145.0	148.0	194.0	192	2.0	12	3
	12	□	MNS1090-L12C	132.8	167.0	170.0	216.0	214	2.0	12	3
	15	□	MNS1090-L15C	165.5	200.0	203.0	249.0	247	2.0	12	3
	20	□	MNS1090-L20C	220.0	255.0	258.0	304.0	302	2.0	12	3
	25	□	MNS1090-L25C	274.5	310.0	313.0	359.0	357	2.0	12	3
	5	★	MNS1090LB	56.5	90.0	90.0	151.0	149	2.0	11	3
	10	□	MNS1090X10DB	111.0	145.0	148.0	209.0	207	2.0	11	3
20	□	MNS1090X20DB	220.0	255.0	258.0	319.0	317	2.0	11	3	
11.0	3	□	MNS1100S-DIN	38.5	55.0	56.0	102.0	100	2.0	12	4
	3	□	MNS1100S-DIN-C	38.5	55.0	56.0	102.0	100	2.0	12	3
	5	□	MNS1100L-DIN	54.5	71.0	72.0	118.0	116	2.0	12	4
	5	●	MNS1100L-DIN-C	54.5	71.0	72.0	118.0	116	2.0	12	3
	8	□	MNS1100-L8C	90.0	123.0	126.0	172.0	170	2.0	12	3
	10	□	MNS1100-L10C	112.0	145.0	148.0	194.0	192	2.0	12	3
	12	●	MNS1100-L12C	134.0	167.0	170.0	216.0	214	2.0	12	3

DC	Bohrtiefe (mm)	TF/15 (L/D)	Bestellnummer	Abmessungen (mm)							Typ
				LU	LCF	LH	OAL	LF	PL	DCONMS	
11.0	15	□	MNS1100-L15C	167.0	200.0	203.0	249.0	247	2.0	12	3
	20	●	MNS1100-L20C	222.0	255.0	258.0	304.0	302	2.0	12	3
	25	□	MNS1100-L25C	277.0	310.0	313.0	359.0	357	2.0	12	3
	5	★	MNS1100LB	57.0	90.0	90.0	151.0	149	2.0	11	3
	10	★	MNS1100X10DB	112.0	145.0	148.0	209.0	207	2.0	11	3
	20	★	MNS1100X20DB	222.0	255.0	258.0	319.0	317	2.0	11	3
11.1	3	□	MNS1110S-DIN	38.4	55.0	56.0	102.0	100	2.0	12	4
	3	□	MNS1110S-DIN-C	38.4	55.0	56.0	102.0	100	2.0	12	3
	5	□	MNS1110L-DIN	54.4	71.0	72.0	118.0	116	2.0	12	4
	5	□	MNS1110L-DIN-C	54.4	71.0	72.0	118.0	116	2.0	12	3
	8	□	MNS1110-L8C	90.8	129.0	132.0	178.0	176	2.0	12	3
	10	□	MNS1110-L10C	113.0	152.0	155.0	201.0	199	2.0	12	3
	12	□	MNS1110-L12C	135.2	175.0	178.0	224.0	222	2.0	12	3
	15	□	MNS1110-L15C	168.5	209.0	212.0	258.0	256	2.0	12	3
	20	□	MNS1110-L20C	224.0	267.0	270.0	316.0	314	2.0	12	3
	25	□	MNS1110-L25C	279.5	324.0	327.0	373.0	371	2.0	12	3
5	★	MNS1110LB	57.5	94.0	98.0	160.0	158	2.0	12	3	
10	□	MNS1110X10DB	113.0	152.0	155.0	217.0	215	2.0	12	3	
20	□	MNS1110X20DB	224.0	267.0	270.0	332.0	330	2.0	12	3	
11.2	3	□	MNS1120S-DIN	38.2	55.0	56.0	102.0	100	2.0	12	4
	3	□	MNS1120S-DIN-C	38.2	55.0	56.0	102.0	100	2.0	12	3
	5	□	MNS1120L-DIN	54.2	71.0	72.0	118.0	116	2.0	12	4
	5	□	MNS1120L-DIN-C	54.2	71.0	72.0	118.0	116	2.0	12	3
	8	□	MNS1120-L8C	91.6	129.0	132.0	178.0	176	2.0	12	3
	10	□	MNS1120-L10C	114.0	152.0	155.0	201.0	199	2.0	12	3
	12	□	MNS1120-L12C	136.4	175.0	178.0	224.0	222	2.0	12	3
	15	□	MNS1120-L15C	170.0	209.0	212.0	258.0	256	2.0	12	3
	20	□	MNS1120-L20C	226.0	267.0	270.0	316.0	314	2.0	12	3
	25	□	MNS1120-L25C	282.0	324.0	327.0	373.0	371	2.0	12	3
5	★	MNS1120LB	58.0	94.0	98.0	160.0	158	2.0	12	3	
10	□	MNS1120X10DB	114.0	152.0	155.0	217.0	215	2.0	12	3	
20	□	MNS1120X20DB	226.0	267.0	270.0	332.0	330	2.0	12	3	
11.3	3	□	MNS1130S-DIN	38.1	55.1	56.1	102.1	100	2.1	12	4
	3	□	MNS1130S-DIN-C	38.1	55.1	56.1	102.1	100	2.1	12	3
	5	□	MNS1130L-DIN	54.1	71.1	72.1	118.1	116	2.1	12	4
	5	□	MNS1130L-DIN-C	54.1	71.1	72.1	118.1	116	2.1	12	3
	8	□	MNS1130-L8C	92.5	129.1	132.1	178.1	176	2.1	12	3
	10	□	MNS1130-L10C	115.1	152.1	155.1	201.1	199	2.1	12	3
	12	□	MNS1130-L12C	137.7	175.1	178.1	224.1	222	2.1	12	3
	15	□	MNS1130-L15C	171.6	209.1	212.1	258.1	256	2.1	12	3
	20	□	MNS1130-L20C	228.1	267.1	270.1	316.1	314	2.1	12	3
	25	□	MNS1130-L25C	284.6	324.1	327.1	373.1	371	2.1	12	3
5	★	MNS1130LB	58.6	94.1	98.1	160.1	158	2.1	12	3	
10	□	MNS1130X10DB	115.1	152.1	155.1	217.1	215	2.1	12	3	
20	□	MNS1130X20DB	228.1	267.1	270.1	332.1	330	2.1	12	3	

M

BOHREN

DC	Bohrtiefe (mm)	TF15 (L/D)	Bestellnummer	Abmessungen (mm)							Typ
				LU	LCF	LH	OAL	LF	PL	DCONMS	
11.4	3	□	MNS1140S-DIN	38.0	55.1	56.1	102.1	100	2.1	12	4
	3	□	MNS1140S-DIN-C	38.0	55.1	56.1	102.1	100	2.1	12	3
	5	□	MNS1140L-DIN	54.0	71.1	72.1	118.1	116	2.1	12	4
	5	□	MNS1140L-DIN-C	54.0	71.1	72.1	118.1	116	2.1	12	3
	8	□	MNS1140-L8C	93.3	129.1	132.1	178.1	176	2.1	12	3
	10	□	MNS1140-L10C	116.1	152.1	155.1	201.1	199	2.1	12	3
	12	□	MNS1140-L12C	138.9	175.1	178.1	224.1	222	2.1	12	3
	15	□	MNS1140-L15C	173.1	209.1	212.1	258.1	256	2.1	12	3
	20	□	MNS1140-L20C	230.1	267.1	270.1	316.1	314	2.1	12	3
	25	□	MNS1140-L25C	287.1	324.1	327.1	373.1	371	2.1	12	3
	5	★	MNS1140LB	59.1	94.1	98.1	160.1	158	2.1	12	3
	10	□	MNS1140X10DB	116.1	152.1	155.1	217.1	215	2.1	12	3
20	□	MNS1140X20DB	230.1	267.1	270.1	332.1	330	2.1	12	3	
11.5	3	□	MNS1150S-DIN	37.8	55.1	56.1	102.1	100	2.1	12	4
	3	□	MNS1150S-DIN-C	37.8	55.1	56.1	102.1	100	2.1	12	3
	5	□	MNS1150L-DIN	53.8	71.1	72.1	118.1	116	2.1	12	4
	5	●	MNS1150L-DIN-C	53.8	71.1	72.1	118.1	116	2.1	12	3
	8	□	MNS1150-L8C	94.1	129.1	132.1	178.1	176	2.1	12	3
	10	□	MNS1150-L10C	117.1	152.1	155.1	201.1	199	2.1	12	3
	12	●	MNS1150-L12C	140.1	175.1	178.1	224.1	222	2.1	12	3
	15	□	MNS1150-L15C	174.6	209.1	212.1	258.1	256	2.1	12	3
	20	●	MNS1150-L20C	232.1	267.1	270.1	316.1	314	2.1	12	3
	25	□	MNS1150-L25C	289.6	324.1	327.1	373.1	371	2.1	12	3
	5	★	MNS1150LB	59.6	94.1	98.1	160.1	158	2.1	12	3
	10	□	MNS1150X10DB	117.1	152.1	155.1	217.1	215	2.1	12	3
20	□	MNS1150X20DB	232.1	267.1	270.1	332.1	330	2.1	12	3	
11.6	3	□	MNS1160S-DIN	37.7	55.1	56.1	102.1	100	2.1	12	4
	3	□	MNS1160S-DIN-C	37.7	55.1	56.1	102.1	100	2.1	12	3
	5	□	MNS1160L-DIN	53.7	71.1	72.1	118.1	116	2.1	12	4
	5	□	MNS1160L-DIN-C	53.7	71.1	72.1	118.1	116	2.1	12	3
	8	□	MNS1160-L8C	94.9	134.1	137.1	183.1	181	2.1	12	3
	10	□	MNS1160-L10C	118.1	158.1	161.1	207.1	205	2.1	12	3
	12	□	MNS1160-L12C	141.3	182.1	185.1	231.1	229	2.1	12	3
	15	□	MNS1160-L15C	176.1	218.1	221.1	267.1	265	2.1	12	3
	20	□	MNS1160-L20C	234.1	278.1	281.1	327.1	325	2.1	12	3
	25	□	MNS1160-L25C	292.1	338.1	341.1	387.1	385	2.1	12	3
	5	★	MNS1160LB	60.1	98.1	98.1	160.1	158	2.1	12	3
	10	□	MNS1160X10DB	118.1	158.1	161.1	223.1	221	2.1	12	3
20	□	MNS1160X20DB	234.1	278.1	281.1	343.1	341	2.1	12	3	
11.7	3	□	MNS1170S-DIN	37.6	55.1	56.1	102.1	100	2.1	12	4
	3	□	MNS1170S-DIN-C	37.6	55.1	56.1	102.1	100	2.1	12	3
	5	□	MNS1170L-DIN	53.6	71.1	72.1	118.1	116	2.1	12	4
	5	□	MNS1170L-DIN-C	53.6	71.1	72.1	118.1	116	2.1	12	3
	8	□	MNS1170-L8C	95.7	134.1	137.1	183.1	181	2.1	12	3
	10	□	MNS1170-L10C	119.1	158.1	161.1	207.1	205	2.1	12	3
	12	□	MNS1170-L12C	142.5	182.1	185.1	231.1	229	2.1	12	3

DC	Bohrtiefe (mm)	TF15 (L/D)	Bestellnummer	Abmessungen (mm)							Typ
				LU	LCF	LH	OAL	LF	PL	DCONMS	
11.7	15	□	MNS1170-L15C	177.6	218.1	221.1	267.1	265	2.1	12	3
	20	□	MNS1170-L20C	236.1	278.1	281.1	327.1	325	2.1	12	3
	25	□	MNS1170-L25C	294.6	338.1	341.1	387.1	385	2.1	12	3
	5	★	MNS1170LB	60.6	98.1	98.1	160.1	158	2.1	12	3
	10	□	MNS1170X10DB	119.1	158.1	161.1	223.1	221	2.1	12	3
	20	□	MNS1170X20DB	236.1	278.1	281.1	343.1	341	2.1	12	3
11.8	3	□	MNS1180S-DIN	37.4	55.1	56.1	102.1	100	2.1	12	4
	3	□	MNS1180S-DIN-C	37.4	55.1	56.1	102.1	100	2.1	12	3
	5	□	MNS1180L-DIN	53.4	71.1	72.1	118.1	116	2.1	12	4
	5	□	MNS1180L-DIN-C	53.4	71.1	72.1	118.1	116	2.1	12	3
	8	□	MNS1180-L8C	96.5	134.1	137.1	183.1	181	2.1	12	3
	10	□	MNS1180-L10C	120.1	158.1	161.1	207.1	205	2.1	12	3
	12	□	MNS1180-L12C	143.7	182.1	185.1	231.1	229	2.1	12	3
	15	□	MNS1180-L15C	179.1	218.1	221.1	267.1	265	2.1	12	3
	20	□	MNS1180-L20C	238.1	278.1	281.1	327.1	325	2.1	12	3
	25	□	MNS1180-L25C	297.1	338.1	341.1	387.1	385	2.1	12	3
5	★	MNS1180LB	61.1	98.1	98.1	160.1	158	2.1	12	3	
10	□	MNS1180X10DB	120.1	158.1	161.1	223.1	221	2.1	12	3	
20	□	MNS1180X20DB	238.1	278.1	281.1	343.1	341	2.1	12	3	
11.9	3	□	MNS1190S-DIN	37.3	55.2	56.2	102.2	100	2.2	12	4
	3	□	MNS1190S-DIN-C	37.3	55.2	56.2	102.2	100	2.2	12	3
	5	□	MNS1190L-DIN	53.3	71.2	72.2	118.2	116	2.2	12	4
	5	□	MNS1190L-DIN-C	53.3	71.2	72.2	118.2	116	2.2	12	3
	8	□	MNS1190-L8C	97.4	134.2	137.2	183.2	181	2.2	12	3
	10	□	MNS1190-L10C	121.2	158.2	161.2	207.2	205	2.2	12	3
	12	□	MNS1190-L12C	145.0	182.2	185.2	231.2	229	2.2	12	3
	15	□	MNS1190-L15C	180.7	218.2	221.2	267.2	265	2.2	12	3
	20	□	MNS1190-L20C	240.2	278.2	281.2	327.2	325	2.2	12	3
	25	□	MNS1190-L25C	299.7	338.2	341.2	387.2	385	2.2	12	3
5	★	MNS1190LB	61.7	98.2	98.2	160.2	158	2.2	12	3	
10	□	MNS1190X10DB	121.2	158.2	161.2	223.2	221	2.2	12	3	
20	□	MNS1190X20DB	240.2	278.2	281.2	343.2	341	2.2	12	3	
12.0	3	□	MNS1200S-DIN	37.2	55.2	56.2	102.2	100	2.2	12	4
	3	□	MNS1200S-DIN-C	37.2	55.2	56.2	102.2	100	2.2	12	3
	5	□	MNS1200L-DIN	53.2	71.2	72.2	118.2	116	2.2	12	4
	5	●	MNS1200L-DIN-C	53.2	71.2	72.2	118.2	116	2.2	12	3
	8	□	MNS1200-L8C	98.2	134.2	137.2	183.2	181	2.2	12	3
	10	□	MNS1200-L10C	122.2	158.2	161.2	207.2	205	2.2	12	3
	12	●	MNS1200-L12C	146.2	182.2	185.2	231.2	229	2.2	12	3
	15	□	MNS1200-L15C	182.2	218.2	221.2	267.2	265	2.2	12	3
	20	●	MNS1200-L20C	242.2	278.2	281.2	327.2	325	2.2	12	3
	25	□	MNS1200-L25C	302.2	338.2	341.2	387.2	385	2.2	12	3
	5	★	MNS1200LB	62.2	98.2	98.2	160.2	158	2.2	12	3
	10	★	MNS1200X10DB	122.2	158.2	161.2	223.2	221	2.2	12	3
20	★	MNS1200X20DB	242.2	278.2	281.2	343.2	341	2.2	12	3	

Hinweis 1) Bei Bedarf von abweichenden Geometrien setzen Sie sich mit uns in Verbindung.  
(Andere Durchmesser und Längen können bestellt werden).

● : Lagerstandard. ★ : Lagerstandard in Japan.

□ : Herstellung nur auf Anfrage

DC	Bohrtiefe (mm)	TF/15 (L/D)	Bestellnummer	Abmessungen (mm)							Typ
				LU	LCF	LH	OAL	LF	PL	DCONMS	
12.1	3	□	MNS1210S-DIN	42.1	60.2	61.2	107.2	105	2.2	14	4
	3	□	MNS1210S-DIN-C	42.1	60.2	61.2	107.2	105	2.2	14	3
	5	□	MNS1210L-DIN	59.1	77.2	78.2	124.2	122	2.2	14	4
	5	□	MNS1210L-DIN-C	59.1	77.2	78.2	124.2	122	2.2	14	3
	8	□	MNS1210-L8C	99.0	140.2	143.2	189.2	187	2.2	14	3
	10	□	MNS1210-L10C	123.2	165.2	168.2	214.2	212	2.2	14	3
	12	□	MNS1210-L12C	147.4	190.2	193.2	239.2	237	2.2	14	3
	15	□	MNS1210-L15C	183.7	227.2	230.2	276.2	274	2.2	14	3
	20	□	MNS1210-L20C	244.2	290.2	293.2	339.2	337	2.2	14	3
	5	★	MNS1210LB	62.7	102.2	106.2	169.2	167	2.2	13	3
10	□	MNS1210X10DB	123.2	165.2	168.2	231.2	229	2.2	13	3	
20	□	MNS1210X20DB	244.2	290.2	293.2	356.2	354	2.2	13	3	
12.2	3	□	MNS1220S-DIN	41.9	60.2	61.2	107.2	105	2.2	14	4
	3	□	MNS1220S-DIN-C	41.9	60.2	61.2	107.2	105	2.2	14	3
	5	□	MNS1220L-DIN	58.9	77.2	78.2	124.2	122	2.2	14	4
	5	□	MNS1220L-DIN-C	58.9	77.2	78.2	124.2	122	2.2	14	3
	8	□	MNS1220-L8C	99.8	140.2	143.2	189.2	187	2.2	14	3
	10	□	MNS1220-L10C	124.2	165.2	168.2	214.2	212	2.2	14	3
	12	□	MNS1220-L12C	148.6	190.2	193.2	239.2	237	2.2	14	3
	15	□	MNS1220-L15C	185.2	227.2	230.2	276.2	274	2.2	14	3
	20	□	MNS1220-L20C	246.2	290.2	293.2	339.2	337	2.2	14	3
	5	★	MNS1220LB	63.2	102.2	106.2	169.2	167	2.2	13	3
10	□	MNS1220X10DB	124.2	165.2	168.2	231.2	229	2.2	13	3	
20	□	MNS1220X20DB	246.2	290.2	293.2	356.2	354	2.2	13	3	
12.3	3	□	MNS1230S-DIN	41.8	60.2	61.2	107.2	105	2.2	14	4
	3	□	MNS1230S-DIN-C	41.8	60.2	61.2	107.2	105	2.2	14	3
	5	□	MNS1230L-DIN	58.8	77.2	78.2	124.2	122	2.2	14	4
	5	□	MNS1230L-DIN-C	58.8	77.2	78.2	124.2	122	2.2	14	3
	8	□	MNS1230-L8C	100.6	140.2	143.2	189.2	187	2.2	14	3
	10	□	MNS1230-L10C	125.2	165.2	168.2	214.2	212	2.2	14	3
	12	□	MNS1230-L12C	149.8	190.2	193.2	239.2	237	2.2	14	3
	15	□	MNS1230-L15C	186.7	227.2	230.2	276.2	274	2.2	14	3
	20	□	MNS1230-L20C	248.2	290.2	293.2	339.2	337	2.2	14	3
	5	★	MNS1230LB	63.7	102.2	106.2	169.2	167	2.2	13	3
10	□	MNS1230X10DB	125.2	165.2	168.2	231.2	229	2.2	13	3	
20	□	MNS1230X20DB	248.2	290.2	293.2	356.2	354	2.2	13	3	
12.4	3	□	MNS1240S-DIN	41.7	60.3	61.3	107.3	105	2.3	14	4
	3	□	MNS1240S-DIN-C	41.7	60.3	61.3	107.3	105	2.3	14	3
	5	□	MNS1240L-DIN	58.7	77.3	78.3	124.3	122	2.3	14	4
	5	□	MNS1240L-DIN-C	58.7	77.3	78.3	124.3	122	2.3	14	3
	8	□	MNS1240-L8C	101.5	140.3	143.3	189.3	187	2.3	14	3
	10	□	MNS1240-L10C	126.3	165.3	168.3	214.3	212	2.3	14	3
	12	□	MNS1240-L12C	151.1	190.3	193.3	239.3	237	2.3	14	3
	15	□	MNS1240-L15C	188.3	227.3	230.3	276.3	274	2.3	14	3
	20	□	MNS1240-L20C	250.3	290.3	293.3	339.3	337	2.3	14	3
	5	★	MNS1240LB	64.3	102.3	106.3	169.3	167	2.3	13	3
10	□	MNS1240X10DB	126.3	165.3	168.3	231.3	229	2.3	13	3	
20	□	MNS1240X20DB	250.3	290.3	293.3	356.3	354	2.3	13	3	

DC	Bohrtiefe (mm)	TF/15 (L/D)	Bestellnummer	Abmessungen (mm)							Typ
				LU	LCF	LH	OAL	LF	PL	DCONMS	
12.5	3	□	MNS1250S-DIN	41.5	60.3	61.3	107.3	105	2.3	14	4
	3	□	MNS1250S-DIN-C	41.5	60.3	61.3	107.3	105	2.3	14	3
	5	□	MNS1250L-DIN	58.5	77.3	78.3	124.3	122	2.3	14	4
	5	●	MNS1250L-DIN-C	58.5	77.3	78.3	124.3	122	2.3	14	3
	8	□	MNS1250-L8C	102.3	140.3	143.3	189.3	187	2.3	14	3
	10	□	MNS1250-L10C	127.3	165.3	168.3	214.3	212	2.3	14	3
	12	●	MNS1250-L12C	152.3	190.3	193.3	239.3	237	2.3	14	3
	15	□	MNS1250-L15C	189.8	227.3	230.3	276.3	274	2.3	14	3
	20	●	MNS1250-L20C	252.3	290.3	293.3	339.3	337	2.3	14	3
	5	★	MNS1250LB	64.8	102.3	106.3	169.3	167	2.3	13	3
10	□	MNS1250X10DB	127.3	165.3	168.3	231.3	229	2.3	13	3	
20	□	MNS1250X20DB	252.3	290.3	293.3	356.3	354	2.3	13	3	
12.6	3	□	MNS1260S-DIN	41.4	60.3	61.3	107.3	105	2.3	14	4
	3	□	MNS1260S-DIN-C	41.4	60.3	61.3	107.3	105	2.3	14	3
	5	□	MNS1260L-DIN	58.4	77.3	78.3	124.3	122	2.3	14	4
	5	□	MNS1260L-DIN-C	58.4	77.3	78.3	124.3	122	2.3	14	3
	8	□	MNS1260-L8C	103.1	145.3	148.3	194.3	192	2.3	14	3
	10	□	MNS1260-L10C	128.3	171.3	174.3	220.3	218	2.3	14	3
	12	□	MNS1260-L12C	153.5	197.3	200.3	246.3	244	2.3	14	3
	15	□	MNS1260-L15C	191.3	236.3	239.3	285.3	283	2.3	14	3
	20	□	MNS1260-L20C	254.3	301.3	304.3	350.3	348	2.3	14	3
	5	★	MNS1260LB	65.3	106.3	106.3	169.3	167	2.3	13	3
10	□	MNS1260X10DB	128.3	171.3	174.3	237.3	235	2.3	13	3	
20	□	MNS1260X20DB	254.3	301.3	304.3	367.3	365	2.3	13	3	
12.7	3	□	MNS1270S-DIN	41.3	60.3	61.3	107.3	105	2.3	14	4
	3	□	MNS1270S-DIN-C	41.3	60.3	61.3	107.3	105	2.3	14	3
	5	□	MNS1270L-DIN	58.3	77.3	78.3	124.3	122	2.3	14	4
	5	□	MNS1270L-DIN-C	58.3	77.3	78.3	124.3	122	2.3	14	3
	8	□	MNS1270-L8C	103.9	145.3	148.3	194.3	192	2.3	14	3
	10	□	MNS1270-L10C	129.3	171.3	174.3	220.3	218	2.3	14	3
	12	□	MNS1270-L12C	154.7	197.3	200.3	246.3	244	2.3	14	3
	15	□	MNS1270-L15C	192.8	236.3	239.3	285.3	283	2.3	14	3
	20	□	MNS1270-L20C	256.3	301.3	304.3	350.3	348	2.3	14	3
	5	★	MNS1270LB	65.8	106.3	106.3	169.3	167	2.3	13	3
10	□	MNS1270X10DB	129.3	171.3	174.3	237.3	235	2.3	13	3	
20	□	MNS1270X20DB	256.3	301.3	304.3	367.3	365	2.3	13	3	
12.8	3	□	MNS1280S-DIN	41.1	60.3	61.3	107.3	105	2.3	14	4
	3	□	MNS1280S-DIN-C	41.1	60.3	61.3	107.3	105	2.3	14	3
	5	□	MNS1280L-DIN	58.1	77.3	78.3	124.3	122	2.3	14	4
	5	□	MNS1280L-DIN-C	58.1	77.3	78.3	124.3	122	2.3	14	3
	8	□	MNS1280-L8C	104.7	145.3	148.3	194.3	192	2.3	14	3
	10	□	MNS1280-L10C	130.3	171.3	174.3	220.3	218	2.3	14	3
	12	□	MNS1280-L12C	155.9	197.3	200.3	246.3	244	2.3	14	3
	15	□	MNS1280-L15C	194.3	236.3	239.3	285.3	283	2.3	14	3
	20	□	MNS1280-L20C	258.3	301.3	304.3	350.3	348	2.3	14	3
	5	★	MNS1280LB	66.3	106.3	106.3	169.3	167	2.3	13	3
10	□	MNS1280X10DB	130.3	171.3	174.3	237.3	235	2.3	13	3	
20	□	MNS1280X20DB	258.3	301.3	304.3	367.3	365	2.3	13	3	

M

BOHREN

DC	Bohrtiefe (mm)	Bohrtiefe (L/D)	TF/15	Bestellnummer	Abmessungen (mm)								Typ
					LU	LCF	LH	OAL	LF	PL	DCONMS		
12.9	3	□		MNS1290S-DIN	41.0	60.3	61.3	107.3	105	2.3	14	4	
	3	□		MNS1290S-DIN-C	41.0	60.3	61.3	107.3	105	2.3	14	3	
	5	□		MNS1290L-DIN	58.0	77.3	78.3	124.3	122	2.3	14	4	
	5	□		MNS1290L-DIN-C	58.0	77.3	78.3	124.3	122	2.3	14	3	
	8	□		MNS1290-L8C	105.5	145.3	148.3	194.3	192	2.3	14	3	
	10	□		MNS1290-L10C	131.3	171.3	174.3	220.3	218	2.3	14	3	
	12	□		MNS1290-L12C	157.1	197.3	200.3	246.3	244	2.3	14	3	
	15	□		MNS1290-L15C	195.8	236.3	239.3	285.3	283	2.3	14	3	
	20	□		MNS1290-L20C	260.3	301.3	304.3	350.3	348	2.3	14	3	
	5	★		MNS1290LB	66.8	106.3	106.3	169.3	167	2.3	13	3	
	10	□		MNS1290X10DB	131.3	171.3	174.3	237.3	235	2.3	13	3	
	20	□		MNS1290X20DB	260.3	301.3	304.3	367.3	365	2.3	13	3	
13.0	3	□		MNS1300S-DIN	40.9	60.4	61.4	107.4	105	2.4	14	4	
	3	□		MNS1300S-DIN-C	40.9	60.4	61.4	107.4	105	2.4	14	3	
	5	□		MNS1300L-DIN	57.9	77.4	78.4	124.4	122	2.4	14	4	
	5	●		MNS1300L-DIN-C	57.9	77.4	78.4	124.4	122	2.4	14	3	
	8	□		MNS1300-L8C	106.4	145.4	148.4	194.4	192	2.4	14	3	
	10	□		MNS1300-L10C	132.4	171.4	174.4	220.4	218	2.4	14	3	
	12	●		MNS1300-L12C	158.4	197.4	200.4	246.4	244	2.4	14	3	
	15	□		MNS1300-L15C	197.4	236.4	239.4	285.4	283	2.4	14	3	
	20	●		MNS1300-L20C	262.4	301.4	304.4	350.4	348	2.4	14	3	
	5	★		MNS1300LB	67.4	106.4	106.4	169.4	167	2.4	13	3	
	10	★		MNS1300X10DB	132.4	171.4	174.4	237.4	235	2.4	13	3	
	20	★		MNS1300X20DB	262.4	301.4	304.4	367.4	365	2.4	13	3	
13.1	3	□		MNS1310S-DIN	40.7	60.4	61.4	107.4	105	2.4	14	4	
	3	□		MNS1310S-DIN-C	40.7	60.4	61.4	107.4	105	2.4	14	3	
	5	□		MNS1310L-DIN	57.7	77.4	78.4	124.4	122	2.4	14	4	
	5	□		MNS1310L-DIN-C	57.7	77.4	78.4	124.4	122	2.4	14	3	
	8	□		MNS1310-L8C	107.2	151.4	154.4	200.4	198	2.4	14	3	
	10	□		MNS1310-L10C	133.4	178.4	181.4	227.4	225	2.4	14	3	
	12	□		MNS1310-L12C	159.6	205.4	208.4	254.4	252	2.4	14	3	
	15	□		MNS1310-L15C	198.9	245.4	248.4	294.4	292	2.4	14	3	
	20	□		MNS1310-L20C	264.4	313.4	316.4	362.4	360	2.4	14	3	
	5	★		MNS1310LB	67.9	110.4	114.4	178.4	176	2.4	14	3	
	10	□		MNS1310X10DB	133.4	178.4	181.4	245.4	243	2.4	14	3	
	20	□		MNS1310X20DB	264.4	313.4	316.4	380.4	378	2.4	14	3	
13.2	3	□		MNS1320S-DIN	40.6	60.4	61.4	107.4	105	2.4	14	4	
	3	□		MNS1320S-DIN-C	40.6	60.4	61.4	107.4	105	2.4	14	3	
	5	□		MNS1320L-DIN	57.6	77.4	78.4	124.4	122	2.4	14	4	
	5	□		MNS1320L-DIN-C	57.6	77.4	78.4	124.4	122	2.4	14	3	
	8	□		MNS1320-L8C	108.0	151.4	154.4	200.4	198	2.4	14	3	
	10	□		MNS1320-L10C	134.4	178.4	181.4	227.4	225	2.4	14	3	
	12	□		MNS1320-L12C	160.8	205.4	208.4	254.4	252	2.4	14	3	
	15	□		MNS1320-L15C	200.4	245.4	248.4	294.4	292	2.4	14	3	
	20	□		MNS1320-L20C	266.4	313.4	316.4	362.4	360	2.4	14	3	
	5	★		MNS1320LB	68.4	110.4	114.4	178.4	176	2.4	14	3	
	10	□		MNS1320X10DB	134.4	178.4	181.4	245.4	243	2.4	14	3	
	20	□		MNS1320X20DB	266.4	313.4	316.4	380.4	378	2.4	14	3	

DC	Bohrtiefe (mm)	Bohrtiefe (L/D)	TF/15	Bestellnummer	Abmessungen (mm)								Typ
					LU	LCF	LH	OAL	LF	PL	DCONMS		
13.3	3	□		MNS1330S-DIN	40.5	60.4	61.4	107.4	105	2.4	14	4	
	3	□		MNS1330S-DIN-C	40.5	60.4	61.4	107.4	105	2.4	14	3	
	5	□		MNS1330L-DIN	57.5	77.4	78.4	124.4	122	2.4	14	4	
	5	□		MNS1330L-DIN-C	57.5	77.4	78.4	124.4	122	2.4	14	3	
	8	□		MNS1330-L8C	108.8	151.4	154.4	200.4	198	2.4	14	3	
	10	□		MNS1330-L10C	135.4	178.4	181.4	227.4	225	2.4	14	3	
	12	□		MNS1330-L12C	162.0	205.4	208.4	254.4	252	2.4	14	3	
	15	□		MNS1330-L15C	201.9	245.4	248.4	294.4	292	2.4	14	3	
	20	□		MNS1330-L20C	268.4	313.4	316.4	362.4	360	2.4	14	3	
	5	★		MNS1330LB	68.9	110.4	114.4	178.4	176	2.4	14	3	
	10	□		MNS1330X10DB	135.4	178.4	181.4	245.4	243	2.4	14	3	
	20	□		MNS1330X20DB	268.4	313.4	316.4	380.4	378	2.4	14	3	
13.4	3	□		MNS1340S-DIN	40.3	60.4	61.4	107.4	105	2.4	14	4	
	3	□		MNS1340S-DIN-C	40.3	60.4	61.4	107.4	105	2.4	14	3	
	5	□		MNS1340L-DIN	57.3	77.4	78.4	124.4	122	2.4	14	4	
	5	□		MNS1340L-DIN-C	57.3	77.4	78.4	124.4	122	2.4	14	3	
	8	□		MNS1340-L8C	109.6	151.4	154.4	200.4	198	2.4	14	3	
	10	□		MNS1340-L10C	136.4	178.4	181.4	227.4	225	2.4	14	3	
	12	□		MNS1340-L12C	163.2	205.4	208.4	254.4	252	2.4	14	3	
	15	□		MNS1340-L15C	203.4	245.4	248.4	294.4	292	2.4	14	3	
	20	□		MNS1340-L20C	270.4	313.4	316.4	362.4	360	2.4	14	3	
	5	★		MNS1340LB	69.4	110.4	114.4	178.4	176	2.4	14	3	
	10	□		MNS1340X10DB	136.4	178.4	181.4	245.4	243	2.4	14	3	
	20	□		MNS1340X20DB	270.4	313.4	316.4	380.4	378	2.4	14	3	
13.5	3	□		MNS1350S-DIN	40.2	60.5	61.5	107.5	105	2.5	14	4	
	3	□		MNS1350S-DIN-C	40.2	60.5	61.5	107.5	105	2.5	14	3	
	5	□		MNS1350L-DIN	57.2	77.5	78.5	124.5	122	2.5	14	4	
	5	●		MNS1350L-DIN-C	57.2	77.5	78.5	124.5	122	2.5	14	3	
	8	□		MNS1350-L8C	110.5	151.5	154.5	200.5	198	2.5	14	3	
	10	□		MNS1350-L10C	137.5	178.5	181.5	227.5	225	2.5	14	3	
	12	●		MNS1350-L12C	164.5	205.5	208.5	254.5	252	2.5	14	3	
	15	□		MNS1350-L15C	205.0	245.5	248.5	294.5	292	2.5	14	3	
	20	●		MNS1350-L20C	272.5	313.5	316.5	362.5	360	2.5	14	3	
	5	★		MNS1350LB	70.0	110.5	114.5	178.5	176	2.5	14	3	
	10	□		MNS1350X10DB	137.5	178.5	181.5	245.5	243	2.5	14	3	
	20	□		MNS1350X20DB	272.5	313.5	316.5	380.5	378	2.5	14	3	
13.6	3	□		MNS1360S-DIN	40.1	60.5	61.5	107.5	105	2.5	14	4	
	3	□		MNS1360S-DIN-C	40.1	60.5	61.5	107.5	105	2.5	14	3	
	5	□		MNS1360L-DIN	57.1	77.5	78.5	124.5	122	2.5	14	4	
	5	□		MNS1360L-DIN-C	57.1	77.5	78.5	124.5	122	2.5	14	3	
	8	□		MNS1360-L8C	111.3	156.5	159.5	205.5	203	2.5	14	3	
	10	□		MNS1360-L10C	138.5	184.5	187.5	233.5	231	2.5	14	3	
	12	□		MNS1360-L12C	165.7	212.5	215.5	261.5	259	2.5	14	3	
	15	□		MNS1360-L15C	206.5	254.5	257.5	303.5	301	2.5	14	3	
	20	□		MNS1360-L20C	274.5	324.5	327.5	373.5	371	2.5	14	3	
	5	★		MNS1360LB	70.5	114.5	114.5	178.5	176	2.5	14	3	
	10	□		MNS1360X10DB	138.5	184.5	187.5	251.5	249	2.5	14	3	
	20	□		MNS1360X20DB	274.5	324.5	327.5	391.5	389	2.5	14	3	

Hinweis 1) Bei Bedarf von abweichenden Geometrien setzen Sie sich mit uns in Verbindung.  
(Andere Durchmesser und Längen können bestellt werden).

● : Lagerstandard. ★ : Lagerstandard in Japan.

□ : Herstellung nur auf Anfrage



DC	Bohrtiefe (mm)	TF/15 (L/D)	Bestellnummer	Abmessungen (mm)							Typ
				LU	LCF	LH	OAL	LF	PL	DCONMS	
13.7	3	□	MNS1370S-DIN	39.9	60.5	61.5	107.5	105	2.5	14	4
	3	□	MNS1370S-DIN-C	39.9	60.5	61.5	107.5	105	2.5	14	3
	5	□	MNS1370L-DIN	56.9	77.5	78.5	124.5	122	2.5	14	4
	5	□	MNS1370L-DIN-C	56.9	77.5	78.5	124.5	122	2.5	14	3
	8	□	MNS1370-L8C	112.1	156.5	159.5	205.5	203	2.5	14	3
	10	□	MNS1370-L10C	139.5	184.5	187.5	233.5	231	2.5	14	3
	12	□	MNS1370-L12C	166.9	212.5	215.5	261.5	259	2.5	14	3
	15	□	MNS1370-L15C	208.0	254.5	257.5	303.5	301	2.5	14	3
	20	□	MNS1370-L20C	276.5	324.5	327.5	373.5	371	2.5	14	3
	5	★	MNS1370LB	71.0	114.5	114.5	178.5	176	2.5	14	3
	10	□	MNS1370X10DB	139.5	184.5	187.5	251.5	249	2.5	14	3
20	□	MNS1370X20DB	276.5	324.5	327.5	391.5	389	2.5	14	3	
13.8	3	□	MNS1380S-DIN	39.8	60.5	61.5	107.5	105	2.5	14	4
	3	□	MNS1380S-DIN-C	39.8	60.5	61.5	107.5	105	2.5	14	3
	5	□	MNS1380L-DIN	56.8	77.5	78.5	124.5	122	2.5	14	4
	5	□	MNS1380L-DIN-C	56.8	77.5	78.5	124.5	122	2.5	14	3
	8	□	MNS1380-L8C	112.9	156.5	159.5	205.5	203	2.5	14	3
	10	□	MNS1380-L10C	140.5	184.5	187.5	233.5	231	2.5	14	3
	12	□	MNS1380-L12C	168.1	212.5	215.5	261.5	259	2.5	14	3
	15	□	MNS1380-L15C	209.5	254.5	257.5	303.5	301	2.5	14	3
	20	□	MNS1380-L20C	278.5	324.5	327.5	373.5	371	2.5	14	3
	5	★	MNS1380LB	71.5	114.5	114.5	178.5	176	2.5	14	3
	10	□	MNS1380X10DB	140.5	184.5	187.5	251.5	249	2.5	14	3
20	□	MNS1380X20DB	278.5	324.5	327.5	391.5	389	2.5	14	3	
13.9	3	□	MNS1390S-DIN	39.7	60.5	61.5	107.5	105	2.5	14	4
	3	□	MNS1390S-DIN-C	39.7	60.5	61.5	107.5	105	2.5	14	3
	5	□	MNS1390L-DIN	56.7	77.5	78.5	124.5	122	2.5	14	4
	5	□	MNS1390L-DIN-C	56.7	77.5	78.5	124.5	122	2.5	14	3
	8	□	MNS1390-L8C	113.7	156.5	159.5	205.5	203	2.5	14	3
	10	□	MNS1390-L10C	141.5	184.5	187.5	233.5	231	2.5	14	3
	12	□	MNS1390-L12C	169.3	212.5	215.5	261.5	259	2.5	14	3
	15	□	MNS1390-L15C	211.0	254.5	257.5	303.5	301	2.5	14	3
	20	□	MNS1390-L20C	280.5	324.5	327.5	373.5	371	2.5	14	3
	5	★	MNS1390LB	72.0	114.5	114.5	178.5	176	2.5	14	3
	10	□	MNS1390X10DB	141.5	184.5	187.5	251.5	249	2.5	14	3
20	□	MNS1390X20DB	280.5	324.5	327.5	391.5	389	2.5	14	3	
14.0	3	□	MNS1400S-DIN	39.5	60.5	61.5	107.5	105	2.5	14	4
	3	□	MNS1400S-DIN-C	39.5	60.5	61.5	107.5	105	2.5	14	3
	5	□	MNS1400L-DIN	56.5	77.5	78.5	124.5	122	2.5	14	4
	5	●	MNS1400L-DIN-C	56.5	77.5	78.5	124.5	122	2.5	14	3
	8	□	MNS1400-L8C	114.5	156.5	159.5	205.5	203	2.5	14	3
	10	□	MNS1400-L10C	142.5	184.5	187.5	233.5	231	2.5	14	3
	12	●	MNS1400-L12C	170.5	212.5	215.5	261.5	259	2.5	14	3
	15	□	MNS1400-L15C	212.5	254.5	257.5	303.5	301	2.5	14	3
	20	●	MNS1400-L20C	282.5	324.5	327.5	373.5	371	2.5	14	3
	5	★	MNS1400LB	72.5	114.5	114.5	178.5	176	2.5	14	3
	10	★	MNS1400X10DB	142.5	184.5	187.5	251.5	249	2.5	14	3
	20	★	MNS1400X20DB	282.5	324.5	327.5	391.5	389	2.5	14	3

DC	Bohrtiefe (mm)	TF/15 (L/D)	Bestellnummer	Abmessungen (mm)							Typ
				LU	LCF	LH	OAL	LF	PL	DCONMS	
14.1	3	□	MNS1410S-DIN	43.4	64.6	65.6	114.6	112	2.6	16	4
	3	□	MNS1410S-DIN-C	43.4	64.6	65.6	114.6	112	2.6	16	3
	5	□	MNS1410L-DIN	61.4	82.6	83.6	132.6	130	2.6	16	4
	5	□	MNS1410L-DIN-C	61.4	82.6	83.6	132.6	130	2.6	16	3
14.2	3	□	MNS1420S-DIN	43.3	64.6	65.6	114.6	112	2.6	16	4
	3	□	MNS1420S-DIN-C	43.3	64.6	65.6	114.6	112	2.6	16	3
	5	□	MNS1420L-DIN	61.3	82.6	83.6	132.6	130	2.6	16	4
14.3	3	□	MNS1430S-DIN	43.2	64.6	65.6	114.6	112	2.6	16	4
	3	□	MNS1430S-DIN-C	43.2	64.6	65.6	114.6	112	2.6	16	3
	5	□	MNS1430L-DIN	61.2	82.6	83.6	132.6	130	2.6	16	4
14.4	3	□	MNS1440S-DIN	43.0	64.6	65.6	114.6	112	2.6	16	4
	3	□	MNS1440S-DIN-C	43.0	64.6	65.6	114.6	112	2.6	16	3
	5	□	MNS1440L-DIN	61.0	82.6	83.6	132.6	130	2.6	16	4
	5	□	MNS1440L-DIN-C	61.0	82.6	83.6	132.6	130	2.6	16	3
14.5	3	□	MNS1450S-DIN	42.9	64.6	65.6	114.6	112	2.6	16	4
	3	□	MNS1450S-DIN-C	42.9	64.6	65.6	114.6	112	2.6	16	3
	5	□	MNS1450L-DIN	60.9	82.6	83.6	132.6	130	2.6	16	4
14.6	3	□	MNS1460S-DIN	42.8	64.7	65.7	114.7	112	2.7	16	4
	3	□	MNS1460S-DIN-C	42.8	64.7	65.7	114.7	112	2.7	16	3
	5	□	MNS1460L-DIN	60.8	82.7	83.7	132.7	130	2.7	16	4
14.7	3	□	MNS1470S-DIN	42.6	64.7	65.7	114.7	112	2.7	16	4
	3	□	MNS1470S-DIN-C	42.6	64.7	65.7	114.7	112	2.7	16	3
	5	□	MNS1470L-DIN	60.6	82.7	83.7	132.7	130	2.7	16	4
14.8	3	□	MNS1480S-DIN	42.5	64.7	65.7	114.7	112	2.7	16	4
	3	□	MNS1480S-DIN-C	42.5	64.7	65.7	114.7	112	2.7	16	3
	5	□	MNS1480L-DIN	60.5	82.7	83.7	132.7	130	2.7	16	4
14.9	3	□	MNS1490S-DIN	42.4	64.7	65.7	114.7	112	2.7	16	4
	3	□	MNS1490S-DIN-C	42.4	64.7	65.7	114.7	112	2.7	16	3
	5	□	MNS1490L-DIN	60.4	82.7	83.7	132.7	130	2.7	16	4
15.0	3	□	MNS1500S-DIN	42.2	64.7	65.7	114.7	112	2.7	16	4
	3	□	MNS1500S-DIN-C	42.2	64.7	65.7	114.7	112	2.7	16	3
	5	□	MNS1500L-DIN	60.2	82.7	83.7	132.7	130	2.7	16	4
15.1	3	□	MNS1510S-DIN	42.1	64.7	65.7	114.7	112	2.7	16	4
	3	□	MNS1510S-DIN-C	42.1	64.7	65.7	114.7	112	2.7	16	3
	5	□	MNS1510L-DIN	60.1	82.7	83.7	132.7	130	2.7	16	4
15.2	3	□	MNS1520S-DIN	42.0	64.8	65.8	114.8	112	2.8	16	4
	3	□	MNS1520S-DIN-C	42.0	64.8	65.8	114.8	112	2.8	16	3
	5	□	MNS1520L-DIN	60.0	82.8	83.8	132.8	130	2.8	16	4

M

BOHREN

DC	Bohrtiefe (mm)	TF15 (L/D)	Bestellnummer	Abmessungen (mm)							Typ
				LU	LCF	LH	OAL	LF	PL	DCONMS	
15.3	3	<input type="checkbox"/>	MNS1530S-DIN	41.8	64.8	65.8	114.8	112	2.8	16	4
	3	<input type="checkbox"/>	MNS1530S-DIN-C	41.8	64.8	65.8	114.8	112	2.8	16	3
	5	<input type="checkbox"/>	MNS1530L-DIN	59.8	82.8	83.8	132.8	130	2.8	16	4
	5	<input type="checkbox"/>	MNS1530L-DIN-C	59.8	82.8	83.8	132.8	130	2.8	16	3
15.4	3	<input type="checkbox"/>	MNS1540S-DIN	41.7	64.8	65.8	114.8	112	2.8	16	4
	3	<input type="checkbox"/>	MNS1540S-DIN-C	41.7	64.8	65.8	114.8	112	2.8	16	3
	5	<input type="checkbox"/>	MNS1540L-DIN	59.7	82.8	83.8	132.8	130	2.8	16	4
	5	<input type="checkbox"/>	MNS1540L-DIN-C	59.7	82.8	83.8	132.8	130	2.8	16	3
15.5	3	<input type="checkbox"/>	MNS1550S-DIN	41.6	64.8	65.8	114.8	112	2.8	16	4
	3	<input type="checkbox"/>	MNS1550S-DIN-C	41.6	64.8	65.8	114.8	112	2.8	16	3
	5	<input type="checkbox"/>	MNS1550L-DIN	59.6	82.8	83.8	132.8	130	2.8	16	4
	5	<input checked="" type="checkbox"/>	MNS1550L-DIN-C	59.6	82.8	83.8	132.8	130	2.8	16	3
15.6	3	<input type="checkbox"/>	MNS1560S-DIN	41.4	64.8	65.8	114.8	112	2.8	16	4
	3	<input type="checkbox"/>	MNS1560S-DIN-C	41.4	64.8	65.8	114.8	112	2.8	16	3
	5	<input type="checkbox"/>	MNS1560L-DIN	59.4	82.8	83.8	132.8	130	2.8	16	4
	5	<input type="checkbox"/>	MNS1560L-DIN-C	59.4	82.8	83.8	132.8	130	2.8	16	3
15.7	3	<input type="checkbox"/>	MNS1570S-DIN	41.3	64.9	65.9	114.9	112	2.9	16	4
	3	<input type="checkbox"/>	MNS1570S-DIN-C	41.3	64.9	65.9	114.9	112	2.9	16	3
	5	<input type="checkbox"/>	MNS1570L-DIN	59.3	82.9	83.9	132.9	130	2.9	16	4
	5	<input type="checkbox"/>	MNS1570L-DIN-C	59.3	82.9	83.9	132.9	130	2.9	16	3
15.8	3	<input type="checkbox"/>	MNS1580S-DIN	41.2	64.9	65.9	114.9	112	2.9	16	4
	3	<input type="checkbox"/>	MNS1580S-DIN-C	41.2	64.9	65.9	114.9	112	2.9	16	3
	5	<input type="checkbox"/>	MNS1580L-DIN	59.2	82.9	83.9	132.9	130	2.9	16	4
	5	<input type="checkbox"/>	MNS1580L-DIN-C	59.2	82.9	83.9	132.9	130	2.9	16	3
15.9	3	<input type="checkbox"/>	MNS1590S-DIN	41.0	64.9	65.9	114.9	112	2.9	16	4
	3	<input type="checkbox"/>	MNS1590S-DIN-C	41.0	64.9	65.9	114.9	112	2.9	16	3
	5	<input type="checkbox"/>	MNS1590L-DIN	59.0	82.9	83.9	132.9	130	2.9	16	4
	5	<input type="checkbox"/>	MNS1590L-DIN-C	59.0	82.9	83.9	132.9	130	2.9	16	3
16.0	3	<input type="checkbox"/>	MNS1600S-DIN	40.9	64.9	65.9	114.9	112	2.9	16	4
	3	<input type="checkbox"/>	MNS1600S-DIN-C	40.9	64.9	65.9	114.9	112	2.9	16	3
	5	<input type="checkbox"/>	MNS1600L-DIN	58.9	82.9	83.9	132.9	130	2.9	16	4
	5	<input checked="" type="checkbox"/>	MNS1600L-DIN-C	58.9	82.9	83.9	132.9	130	2.9	16	3
16.1	3	<input type="checkbox"/>	MNS1610S-DIN	48.8	72.9	73.9	122.9	120	2.9	18	4
	3	<input type="checkbox"/>	MNS1610S-DIN-C	48.8	72.9	73.9	122.9	120	2.9	18	3
	5	<input type="checkbox"/>	MNS1610L-DIN	68.8	92.9	93.9	142.9	140	2.9	18	4
	5	<input type="checkbox"/>	MNS1610L-DIN-C	68.8	92.9	93.9	142.9	140	2.9	18	3
16.2	3	<input type="checkbox"/>	MNS1620S-DIN	48.6	72.9	73.9	122.9	120	2.9	18	4
	3	<input type="checkbox"/>	MNS1620S-DIN-C	48.6	72.9	73.9	122.9	120	2.9	18	3
	5	<input type="checkbox"/>	MNS1620L-DIN	68.6	92.9	93.9	142.9	140	2.9	18	4
	5	<input type="checkbox"/>	MNS1620L-DIN-C	68.6	92.9	93.9	142.9	140	2.9	18	3
16.3	3	<input type="checkbox"/>	MNS1630S-DIN	48.5	73.0	74.0	123.0	120	3.0	18	4
	3	<input type="checkbox"/>	MNS1630S-DIN-C	48.5	73.0	74.0	123.0	120	3.0	18	3
	5	<input type="checkbox"/>	MNS1630L-DIN	68.5	93.0	94.0	143.0	140	3.0	18	4
	5	<input type="checkbox"/>	MNS1630L-DIN-C	68.5	93.0	94.0	143.0	140	3.0	18	3
16.4	3	<input type="checkbox"/>	MNS1640S-DIN	48.4	73.0	74.0	123.0	120	3.0	18	4
	3	<input type="checkbox"/>	MNS1640S-DIN-C	48.4	73.0	74.0	123.0	120	3.0	18	3
	5	<input type="checkbox"/>	MNS1640L-DIN	68.4	93.0	94.0	143.0	140	3.0	18	4
	5	<input type="checkbox"/>	MNS1640L-DIN-C	68.4	93.0	94.0	143.0	140	3.0	18	3

DC	Bohrtiefe (mm)	TF15 (L/D)	Bestellnummer	Abmessungen (mm)							Typ
				LU	LCF	LH	OAL	LF	PL	DCONMS	
16.5	3	<input type="checkbox"/>	MNS1650S-DIN	48.3	73.0	74.0	123.0	120	3.0	18	4
	3	<input type="checkbox"/>	MNS1650S-DIN-C	48.3	73.0	74.0	123.0	120	3.0	18	3
	5	<input type="checkbox"/>	MNS1650L-DIN	68.3	93.0	94.0	143.0	140	3.0	18	4
	5	<input checked="" type="checkbox"/>	MNS1650L-DIN-C	68.3	93.0	94.0	143.0	140	3.0	18	3
16.6	3	<input type="checkbox"/>	MNS1660S-DIN	48.1	73.0	74.0	123.0	120	3.0	18	4
	3	<input type="checkbox"/>	MNS1660S-DIN-C	48.1	73.0	74.0	123.0	120	3.0	18	3
	5	<input type="checkbox"/>	MNS1660L-DIN	68.1	93.0	94.0	143.0	140	3.0	18	4
	5	<input type="checkbox"/>	MNS1660L-DIN-C	68.1	93.0	94.0	143.0	140	3.0	18	3
16.7	3	<input type="checkbox"/>	MNS1670S-DIN	48.0	73.0	74.0	123.0	120	3.0	18	4
	3	<input type="checkbox"/>	MNS1670S-DIN-C	48.0	73.0	74.0	123.0	120	3.0	18	3
	5	<input type="checkbox"/>	MNS1670L-DIN	68.0	93.0	94.0	143.0	140	3.0	18	4
	5	<input type="checkbox"/>	MNS1670L-DIN-C	68.0	93.0	94.0	143.0	140	3.0	18	3
16.8	3	<input type="checkbox"/>	MNS1680S-DIN	47.9	73.1	74.1	123.1	120	3.1	18	4
	3	<input type="checkbox"/>	MNS1680S-DIN-C	47.9	73.1	74.1	123.1	120	3.1	18	3
	5	<input type="checkbox"/>	MNS1680L-DIN	67.9	93.1	94.1	143.1	140	3.1	18	4
	5	<input type="checkbox"/>	MNS1680L-DIN-C	67.9	93.1	94.1	143.1	140	3.1	18	3
16.9	3	<input type="checkbox"/>	MNS1690S-DIN	47.7	73.1	74.1	123.1	120	3.1	18	4
	3	<input type="checkbox"/>	MNS1690S-DIN-C	47.7	73.1	74.1	123.1	120	3.1	18	3
	5	<input type="checkbox"/>	MNS1690L-DIN	67.7	93.1	94.1	143.1	140	3.1	18	4
	5	<input type="checkbox"/>	MNS1690L-DIN-C	67.7	93.1	94.1	143.1	140	3.1	18	3
17.0	3	<input type="checkbox"/>	MNS1700S-DIN	47.6	73.1	74.1	123.1	120	3.1	18	4
	3	<input type="checkbox"/>	MNS1700S-DIN-C	47.6	73.1	74.1	123.1	120	3.1	18	3
	5	<input type="checkbox"/>	MNS1700L-DIN	67.6	93.1	94.1	143.1	140	3.1	18	4
	5	<input checked="" type="checkbox"/>	MNS1700L-DIN-C	67.6	93.1	94.1	143.1	140	3.1	18	3
17.1	3	<input type="checkbox"/>	MNS1710S-DIN	47.5	73.1	74.1	123.1	120	3.1	18	4
	3	<input type="checkbox"/>	MNS1710S-DIN-C	47.5	73.1	74.1	123.1	120	3.1	18	3
	5	<input type="checkbox"/>	MNS1710L-DIN	67.5	93.1	94.1	143.1	140	3.1	18	4
	5	<input type="checkbox"/>	MNS1710L-DIN-C	67.5	93.1	94.1	143.1	140	3.1	18	3
17.2	3	<input type="checkbox"/>	MNS1720S-DIN	47.3	73.1	74.1	123.1	120	3.1	18	4
	3	<input type="checkbox"/>	MNS1720S-DIN-C	47.3	73.1	74.1	123.1	120	3.1	18	3
	5	<input type="checkbox"/>	MNS1720L-DIN	67.3	93.1	94.1	143.1	140	3.1	18	4
	5	<input type="checkbox"/>	MNS1720L-DIN-C	67.3	93.1	94.1	143.1	140	3.1	18	3
17.3	3	<input type="checkbox"/>	MNS1730S-DIN	47.2	73.1	74.1	123.1	120	3.1	18	4
	3	<input type="checkbox"/>	MNS1730S-DIN-C	47.2	73.1	74.1	123.1	120	3.1	18	3
	5	<input type="checkbox"/>	MNS1730L-DIN	67.2	93.1	94.1	143.1	140	3.1	18	4
	5	<input type="checkbox"/>	MNS1730L-DIN-C	67.2	93.1	94.1	143.1	140	3.1	18	3
17.4	3	<input type="checkbox"/>	MNS1740S-DIN	47.1	73.2	74.2	123.2	120	3.2	18	4
	3	<input type="checkbox"/>	MNS1740S-DIN-C	47.1	73.2	74.2	123.2	120	3.2	18	3
	5	<input type="checkbox"/>	MNS1740L-DIN	67.1	93.2	94.2	143.2	140	3.2	18	4
	5	<input type="checkbox"/>	MNS1740L-DIN-C	67.1	93.2	94.2	143.2	140	3.2	18	3
17.5	3	<input type="checkbox"/>	MNS1750S-DIN	46.9	73.2	74.2	123.2	120	3.2	18	4
	3	<input type="checkbox"/>	MNS1750S-DIN-C	46.9	73.2	74.2	123.2	120	3.2	18	3
	5	<input type="checkbox"/>	MNS1750L-DIN	66.9	93.2	94.2	143.2	140	3.2	18	4
	5	<input checked="" type="checkbox"/>	MNS1750L-DIN-C	66.9	93.2	94.2	143.2	140	3.2	18	3
17.6	3	<input type="checkbox"/>	MNS1760S-DIN	46.8	73.2	74.2	123.2	120	3.2	18	4
	3	<input type="checkbox"/>	MNS1760S-DIN-C	46.8	73.2	74.2	123.2	120	3.2	18	3
	5	<input type="checkbox"/>	MNS1760L-DIN	66.8	93.2	94.2	143.2	140	3.2	18	4
	5	<input type="checkbox"/>	MNS1760L-DIN-C	66.8	93.2	94.2	143.2	140	3.2	18	3

Hinweis 1) Bei Bedarf von abweichenden Geometrien setzen Sie sich mit uns in Verbindung.  
(Andere Durchmesser und Längen können bestellt werden).

● : Lagerstandard. □ : Herstellung nur auf Anfrage

DC	Bohrtiefe (mm)	TF15 (L/D)	Bestellnummer	Abmessungen (mm)							Typ
				LU	LCF	LH	OAL	LF	PL	DCONMS	
17.7	3	□	MNS1770S-DIN	46.7	73.2	74.2	123.2	120	3.2	18	4
	3	□	MNS1770S-DIN-C	46.7	73.2	74.2	123.2	120	3.2	18	3
	5	□	MNS1770L-DIN	66.7	93.2	94.2	143.2	140	3.2	18	4
	5	□	MNS1770L-DIN-C	66.7	93.2	94.2	143.2	140	3.2	18	3
17.8	3	□	MNS1780S-DIN	46.5	73.2	74.2	123.2	120	3.2	18	4
	3	□	MNS1780S-DIN-C	46.5	73.2	74.2	123.2	120	3.2	18	3
	5	□	MNS1780L-DIN	66.5	93.2	94.2	143.2	140	3.2	18	4
	5	□	MNS1780L-DIN-C	66.5	93.2	94.2	143.2	140	3.2	18	3
17.9	3	□	MNS1790S-DIN	46.4	73.3	74.3	123.3	120	3.3	18	4
	3	□	MNS1790S-DIN-C	46.4	73.3	74.3	123.3	120	3.3	18	3
	5	□	MNS1790L-DIN	66.4	93.3	94.3	143.3	140	3.3	18	4
	5	□	MNS1790L-DIN-C	66.4	93.3	94.3	143.3	140	3.3	18	3
18.0	3	□	MNS1800S-DIN	46.3	73.3	74.3	123.3	120	3.3	18	4
	3	□	MNS1800S-DIN-C	46.3	73.3	74.3	123.3	120	3.3	18	3
	5	□	MNS1800L-DIN	66.3	93.3	94.3	143.3	140	3.3	18	4
	5	●	MNS1800L-DIN-C	66.3	93.3	94.3	143.3	140	3.3	18	3
18.1	3	□	MNS1810S-DIN	52.1	79.3	80.3	131.3	128	3.3	20	4
	3	□	MNS1810S-DIN-C	52.1	79.3	80.3	131.3	128	3.3	20	3
	5	□	MNS1810L-DIN	74.1	101.3	102.3	153.3	150	3.3	20	4
	5	□	MNS1810L-DIN-C	74.1	101.3	102.3	153.3	150	3.3	20	3
18.2	3	□	MNS1820S-DIN	52.0	79.3	80.3	131.3	128	3.3	20	4
	3	□	MNS1820S-DIN-C	52.0	79.3	80.3	131.3	128	3.3	20	3
	5	□	MNS1820L-DIN	74.0	101.3	102.3	153.3	150	3.3	20	4
	5	□	MNS1820L-DIN-C	74.0	101.3	102.3	153.3	150	3.3	20	3
18.3	3	□	MNS1830S-DIN	51.9	79.3	80.3	131.3	128	3.3	20	4
	3	□	MNS1830S-DIN-C	51.9	79.3	80.3	131.3	128	3.3	20	3
	5	□	MNS1830L-DIN	73.9	101.3	102.3	153.3	150	3.3	20	4
	5	□	MNS1830L-DIN-C	73.9	101.3	102.3	153.3	150	3.3	20	3
18.4	3	□	MNS1840S-DIN	51.7	79.3	80.3	131.3	128	3.3	20	4
	3	□	MNS1840S-DIN-C	51.7	79.3	80.3	131.3	128	3.3	20	3
	5	□	MNS1840L-DIN	73.7	101.3	102.3	153.3	150	3.3	20	4
	5	□	MNS1840L-DIN-C	73.7	101.3	102.3	153.3	150	3.3	20	3
18.5	3	□	MNS1850S-DIN	51.6	79.4	80.4	131.4	128	3.4	20	4
	3	□	MNS1850S-DIN-C	51.6	79.4	80.4	131.4	128	3.4	20	3
	5	□	MNS1850L-DIN	73.6	101.4	102.4	153.4	150	3.4	20	4
	5	●	MNS1850L-DIN-C	73.6	101.4	102.4	153.4	150	3.4	20	3
18.6	3	□	MNS1860S-DIN	51.5	79.4	80.4	131.4	128	3.4	20	4
	3	□	MNS1860S-DIN-C	51.5	79.4	80.4	131.4	128	3.4	20	3
	5	□	MNS1860L-DIN	73.5	101.4	102.4	153.4	150	3.4	20	4
	5	□	MNS1860L-DIN-C	73.5	101.4	102.4	153.4	150	3.4	20	3
18.7	3	□	MNS1870S-DIN	51.4	79.4	80.4	131.4	128	3.4	20	4
	3	□	MNS1870S-DIN-C	51.4	79.4	80.4	131.4	128	3.4	20	3
	5	□	MNS1870L-DIN	73.4	101.4	102.4	153.4	150	3.4	20	4
	5	□	MNS1870L-DIN-C	73.4	101.4	102.4	153.4	150	3.4	20	3
18.8	3	□	MNS1880S-DIN	51.2	79.4	80.4	131.4	128	3.4	20	4
	3	□	MNS1880S-DIN-C	51.2	79.4	80.4	131.4	128	3.4	20	3
	5	□	MNS1880L-DIN	73.2	101.4	102.4	153.4	150	3.4	20	4
	5	□	MNS1880L-DIN-C	73.2	101.4	102.4	153.4	150	3.4	20	3

DC	Bohrtiefe (mm)	TF15 (L/D)	Bestellnummer	Abmessungen (mm)							Typ
				LU	LCF	LH	OAL	LF	PL	DCONMS	
18.9	3	□	MNS1890S-DIN	51.1	79.4	80.4	131.4	128	3.4	20	4
	3	□	MNS1890S-DIN-C	51.1	79.4	80.4	131.4	128	3.4	20	3
	5	□	MNS1890L-DIN	73.1	101.4	102.4	153.4	150	3.4	20	4
	5	□	MNS1890L-DIN-C	73.1	101.4	102.4	153.4	150	3.4	20	3
19.0	3	□	MNS1900S-DIN	51.0	79.5	80.5	131.5	128	3.5	20	4
	3	□	MNS1900S-DIN-C	51.0	79.5	80.5	131.5	128	3.5	20	3
	5	□	MNS1900L-DIN	73.0	101.5	102.5	153.5	150	3.5	20	4
	5	□	MNS1900L-DIN-C	73.0	101.5	102.5	153.5	150	3.5	20	3
19.1	3	□	MNS1910S-DIN	50.8	79.5	80.5	131.5	128	3.5	20	4
	3	□	MNS1910S-DIN-C	50.8	79.5	80.5	131.5	128	3.5	20	3
	5	□	MNS1910L-DIN	72.8	101.5	102.5	153.5	150	3.5	20	4
	5	□	MNS1910L-DIN-C	72.8	101.5	102.5	153.5	150	3.5	20	3
19.2	3	□	MNS1920S-DIN	50.7	79.5	80.5	131.5	128	3.5	20	4
	3	□	MNS1920S-DIN-C	50.7	79.5	80.5	131.5	128	3.5	20	3
	5	□	MNS1920L-DIN	72.7	101.5	102.5	153.5	150	3.5	20	4
	5	□	MNS1920L-DIN-C	72.7	101.5	102.5	153.5	150	3.5	20	3
19.3	3	□	MNS1930S-DIN	50.6	79.5	80.5	131.5	128	3.5	20	4
	5	□	MNS1930L-DIN	72.6	101.5	102.5	153.5	150	3.5	20	4
	5	□	MNS1930L-DIN-C	72.6	101.5	102.5	153.5	150	3.5	20	3
19.4	3	□	MNS1940S-DIN	50.4	79.5	80.5	131.5	128	3.5	20	4
	3	□	MNS1940S-DIN-C	50.4	79.5	80.5	131.5	128	3.5	20	3
	5	□	MNS1940L-DIN	72.4	101.5	102.5	153.5	150	3.5	20	4
	5	□	MNS1940L-DIN-C	72.4	101.5	102.5	153.5	150	3.5	20	3
19.5	3	□	MNS1950S-DIN	50.3	79.5	80.5	131.5	128	3.5	20	4
	3	□	MNS1950S-DIN-C	50.3	79.5	80.5	131.5	128	3.5	20	3
	5	□	MNS1950L-DIN	72.3	101.5	102.5	153.5	150	3.5	20	4
	5	●	MNS1950L-DIN-C	72.3	101.5	102.5	153.5	150	3.5	20	3
19.6	3	□	MNS1960S-DIN	50.2	79.6	80.6	131.6	128	3.6	20	4
	3	□	MNS1960S-DIN-C	50.2	79.6	80.6	131.6	128	3.6	20	3
	5	□	MNS1960L-DIN	72.2	101.6	102.6	153.6	150	3.6	20	4
	5	□	MNS1960L-DIN-C	72.2	101.6	102.6	153.6	150	3.6	20	3
19.7	3	□	MNS1970S-DIN	50.0	79.6	80.6	131.6	128	3.6	20	4
	3	□	MNS1970S-DIN-C	50.0	79.6	80.6	131.6	128	3.6	20	3
	5	□	MNS1970L-DIN	72.0	101.6	102.6	153.6	150	3.6	20	4
	5	□	MNS1970L-DIN-C	72.0	101.6	102.6	153.6	150	3.6	20	3
19.8	3	□	MNS1980S-DIN	49.9	79.6	80.6	131.6	128	3.6	20	4
	3	□	MNS1980S-DIN-C	49.9	79.6	80.6	131.6	128	3.6	20	3
	5	□	MNS1980L-DIN	71.9	101.6	102.6	153.6	150	3.6	20	4
	5	□	MNS1980L-DIN-C	71.9	101.6	102.6	153.6	150	3.6	20	3
19.9	3	□	MNS1990S-DIN	49.8	79.6	80.6	131.6	128	3.6	20	4
	3	□	MNS1990S-DIN-C	49.8	79.6	80.6	131.6	128	3.6	20	3
	5	□	MNS1990L-DIN	71.8	101.6	102.6	153.6	150	3.6	20	4
	5	□	MNS1990L-DIN-C	71.8	101.6	102.6	153.6	150	3.6	20	3
20.0	3	□	MNS2000S-DIN	49.6	79.6	80.6	131.6	128	3.6	20	4
	3	□	MNS2000S-DIN-C	49.6	79.6	80.6	131.6	128	3.6	20	3
	5	□	MNS2000L-DIN	71.6	101.6	102.6	153.6	150	3.6	20	4
	5	●	MNS2000L-DIN-C	71.6	101.6	102.6	153.6	150	3.6	20	3

M

BOHREN

## SCHNITTDATENEMPFEHLUNGEN

### Bohrtiefe : L/D = 3, 5, 8 (LB, S-DIN, S-DIN-C, L-DIN, L-DIN-C, L8C -Bohrer)

Material	N								
	Aluminium Leg. (Si<5%)		Aluminium Leg. (5%≤Si≤10%)		Aluminium Leg. (Si>10%)				
Bohrer Durchm. DC (mm)	Drehzahl (min <sup>-1</sup> )	Vorschub (min. – max.) (mm/U.)		Drehzahl (min <sup>-1</sup> )	Vorschub (min. – max.) (mm/U.)				
<b>3.2</b>	11900	0.1	(0.11–0.16)	11900	0.15	(0.16–0.21)	11900	0.15	(0.16–0.21)
<b>4.0</b>	9500	0.15	(0.13–0.20)	9500	0.2	(0.20–0.27)	9500	0.2	(0.20–0.27)
<b>5.0</b>	7600	0.2	(0.17–0.25)	7600	0.25	(0.25–0.33)	7600	0.25	(0.25–0.33)
<b>6.3</b>	7500	0.25	(0.21–0.32)	7500	0.35	(0.32–0.42)	7500	0.35	(0.32–0.42)
<b>8.0</b>	5900	0.3	(0.27–0.40)	5900	0.45	(0.40–0.53)	5900	0.45	(0.40–0.53)
<b>10.0</b>	4700	0.4	(0.33–0.50)	4700	0.55	(0.50–0.67)	4700	0.55	(0.50–0.67)
<b>12.0</b>	5300	0.5	(0.40–0.60)	5300	0.7	(0.60–0.80)	5300	0.7	(0.60–0.80)
<b>14.0</b>	4500	0.5	(0.40–0.60)	4500	0.7	(0.60–0.80)	4500	0.7	(0.60–0.80)
<b>16.0</b>	4000	0.5	(0.40–0.60)	4000	0.7	(0.60–0.80)	4000	0.7	(0.60–0.80)
<b>18.0</b>	3500	0.5	(0.40–0.60)	3500	0.7	(0.60–0.80)	3500	0.7	(0.60–0.80)
<b>20.0</b>	3200	0.5	(0.40–0.60)	3200	0.7	(0.60–0.80)	3200	0.7	(0.60–0.80)

Hinweis 1) Wenn der Bohrer mit einer Länge über L/D 10 verwendet wird, müssen Pilotbohrungen als Führung zum Einsatz kommen.

(Ohne Pilotbohrung kann der Bohrer brechen.)

Hinweis 2) Für die Pilotbohrung empfehlen wir die MNS-Bohrerserie oder alternativ die MAE-MB oder MAS-MB-Bohrer.

### Bohrtiefe : L/D = 10, 12, 15, 20, 25, 30 (X10DB, X20DB, X30DB, L10C, L12C, L15C, L20C, L25C, L30C -Bohrer)

Material	N								
	Aluminium Leg. (Si<5%)		Aluminium Leg. (5%≤Si≤10%)		Aluminium Leg. (Si>10%)				
Bohrer Durchm. DC (mm)	Drehzahl (min <sup>-1</sup> )	Vorschub (min. – max.) (mm/U.)		Drehzahl (min <sup>-1</sup> )	Vorschub (min. – max.) (mm/U.)				
<b>3.2</b>	8900	0.1	(0.11–0.16)	8900	0.15	(0.16–0.21)	8900	0.15	(0.16–0.21)
<b>4.0</b>	7100	0.15	(0.13–0.20)	7100	0.2	(0.20–0.27)	7100	0.2	(0.20–0.27)
<b>5.0</b>	5700	0.2	(0.17–0.25)	5700	0.25	(0.25–0.33)	5700	0.25	(0.25–0.33)
<b>6.3</b>	6000	0.25	(0.21–0.32)	6000	0.35	(0.32–0.42)	6000	0.35	(0.32–0.42)
<b>8.0</b>	4700	0.3	(0.27–0.40)	4700	0.45	(0.40–0.53)	4700	0.45	(0.40–0.53)
<b>10.0</b>	3800	0.4	(0.33–0.50)	3800	0.55	(0.50–0.67)	3800	0.55	(0.50–0.67)
<b>12.0</b>	4200	0.5	(0.40–0.60)	4200	0.7	(0.60–0.80)	4200	0.7	(0.60–0.80)
<b>14.0</b>	3600	0.5	(0.40–0.60)	3600	0.7	(0.60–0.80)	3600	0.7	(0.60–0.80)
<b>16.0</b>	3200	0.5	(0.40–0.60)	3200	0.7	(0.60–0.80)	3200	0.7	(0.60–0.80)
<b>18.0</b>	2800	0.5	(0.40–0.60)	2800	0.7	(0.60–0.80)	2800	0.7	(0.60–0.80)
<b>20.0</b>	2500	0.5	(0.40–0.60)	2500	0.7	(0.60–0.80)	2500	0.7	(0.60–0.80)

Hinweis 1) Wenn der Bohrer mit einer Länge über L/D 10 verwendet wird, müssen Pilotbohrungen als Führung zum Einsatz kommen.

(Ohne Pilotbohrung kann der Bohrer brechen.)

Hinweis 2) Für die Pilotbohrung empfehlen wir die MNS-Bohrerserie oder alternativ MAE-MB oder MAS-MB-Bohrer.

## ■ HINWEISE ZUR VERWENDUNG DES MNS-BOHRERS (L/D 3, 5, 8)

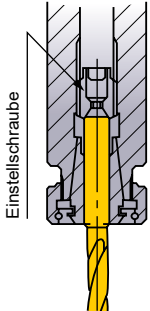
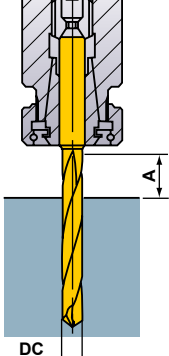
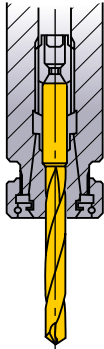
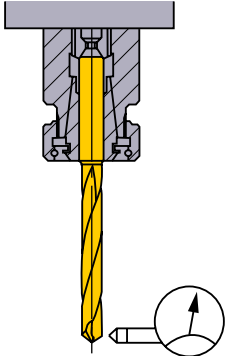
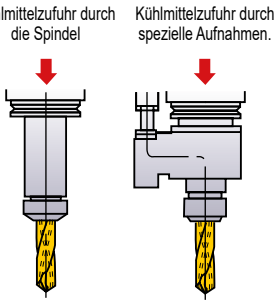
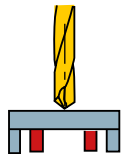
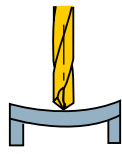
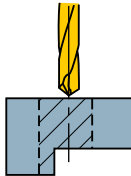
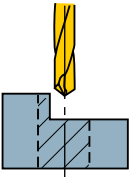
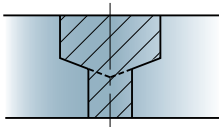
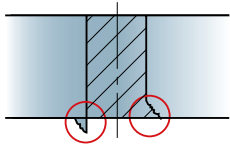
<p><b>Bohrer-Aufnahme</b></p>  <p>Präzisionsspannzangen können verwendet werden.</p>	<p><b>Max. Bohrtiefe</b></p>  <p><math>A : \geq DC \times 1.5</math></p>	<p><b>Bohrer-Einstellung</b></p>  <p>Nicht auf den Nuten spannen.</p>	<p><b>Rundlauftoleranz</b></p>  <p>Rundlaufabweichung <math>\leq 0.03\text{mm}</math></p>
<p><b>Kühlmittelezufuhr (MNS)</b></p>  <p>Kühlmittelezufuhr durch die Spindel      Kühlmittelezufuhr durch spezielle Aufnahmen.</p> <p>Kühlmitteldruck liegt bei etwa: 5 bar – 70 bar</p>	<p><b>Handling mit Kühlmittel</b></p> <p>&lt;Typ <b>MNS</b>&gt;</p> <ol style="list-style-type: none"> <li>1) Schmutz- und Staubpartikel in altem Kühlmittel können die Kühlkanalbohrungen blockieren und einen effektiven Durchfluss verhindern. Der regelmäßige Austausch des Kühlmittels wird empfohlen.</li> <li>2) Kleine Späne könnten sich in den Kühlkanalbohrungen verkanten. Verwenden Sie daher einen Filter, um dies zu verhindern. Beim Einsatz von Bohrern mit kleinem Durchmesser empfiehlt sich ein feinmaschiger Filter.</li> </ol>	<p><b>Dünne Werkstücke</b></p>  <p><b>OK</b> Stützen Sie das Werkstück.</p>  <p><b>X</b> Wenn Werkstücke verbiegen...</p>	<p><b>Unterbrochene Bearbeitung</b></p>  <p><b>Ohne Vorbearbeitung</b> <b>OK</b> ① Reduzieren Sie den Vorschub an der unterbrochenen Stelle.</p>  <p><b>Benötigt Vorbearbeitung</b> ① Planen Sie die Fläche mit einem Fräser vorab.</p>
<p><b>Stufenbohrungen</b></p>  <ol style="list-style-type: none"> <li>① Unterteilen Sie die Bearbeitung in zwei Prozesse.</li> <li>② Bohren Sie die größere Bohrung zuerst.</li> </ol> <p>*Werkzeuge zum Anfasen und Anspiegeln können auf Anfrage hergestellt werden.</p>	<p><b>Gratbildung oder Ausbrüche am Werkstück</b></p>  <ol style="list-style-type: none"> <li>① Verringern Sie den Vorschub, wenn Sie den Durchbruch erreichen.</li> <li>② Eine Fase einbeziehen.</li> <li>③ Tauschen Sie den Bohrer durch einen anderen mit größerem Spitzenwinkel.</li> </ol>		

## ■ BENUTZERHINWEISE FÜR MNS-TIEFLOCHBOHRER (L/D ≥ 10)

### BOHREN AUF EINER EBENEN FLÄCHE

#### ■ 1. Pilotbohrung setzen

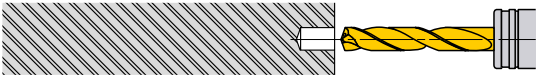

- ① Verwenden Sie den kürzestmöglichen MNS-Bohrer.
- ② Die Pilotbohrung muss ca. 1DC oder tiefer sein (auf Präzision achten).

#### ■ 2. Einfahren in die Pilotbohrung

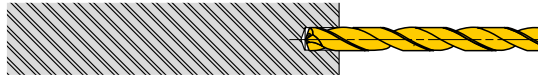

- ① Mit niedriger Drehzahl in die Pilotbohrung einfahren. (Drehzahl 500 min<sup>-1</sup>, Vorschub 0.2 – 0.3mm/U)
- ② Tieflochbohrer 0.5–1mm vor dem Boden der Pilotbohrung stoppen.

#### ■ 3. Tieflochbohren

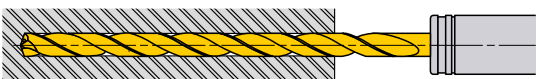

- ① Mit der empfohlenen Drehzahl und Vorschubrate in einem gleichmäßigen Zyklus (kontinuierlicher Vorschub) bis zur gewünschten Bohrungstiefe bohren (ohne zu lüften).

#### ■ 4. Herausfahren des Tieflochbohrers

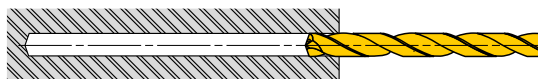

- ① Reduzieren Sie nach Erreichen der Bohrtiefe die Drehzahl. (Drehzahl 500min<sup>-1</sup>)
- ② Bohrer bis zur Tiefe der Pilotbohrung (1DC) bei einem Vorschub von 3000mm/min zurückfahren.
- ③ Fahren Sie den Bohrer anschließend mit einem Vorschub von 0.2–0.3mm/U ganz heraus.

### BOHREN AUF UNEBENEN FLÄCHEN

#### ■ 1. Anspiegeln



- ① Bearbeiten Sie die unebene Fläche mit einem geeigneten Schaftfräser oder Flachbohrer, der zum Anspiegeln geeignet ist. Der Durchmesser der Planfläche muss mindestens so groß wie der Durchmesser des Tieflochbohrers sein (auf Durchmessertoleranzen achten).

#### ■ 2. Pilotbohrung setzen



- ① Verwenden Sie den kürzestmöglichen MNS-Bohrer.
- ② Die Pilotbohrung muss ca. 1DC oder tiefer sein (auf Präzision achten).

#### ■ 3. Einfahren in die Pilotbohrung



- ① Mit niedriger Drehzahl in die Pilotbohrung einfahren. (Drehzahl 500 min<sup>-1</sup>, Vorschub 0.2 – 0.3mm/U)
- ② Tieflochbohrer 0.5–1mm vor dem Boden der Pilotbohrung stoppen.

#### ■ 4. Tieflochbohren

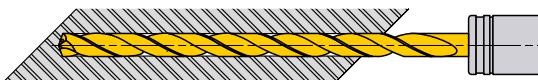

- ① Mit der empfohlenen Drehzahl und Vorschubrate in einem gleichmäßigen Zyklus (kontinuierlicher Vorschub) bis zur gewünschten Bohrungstiefe bohren (ohne zu lüften).

#### ■ 5. Durchbohren

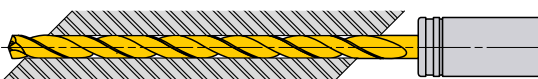

- ① Reduzieren Sie den Vorschub beim Austritt aus der Bohrung, um Beschädigungen an der Schneidkante zu vermeiden.

#### ■ 6. Herausfahren des Bohrers



- ① Reduzieren Sie nach Erreichen der Bohrtiefe die Drehzahl. (Drehzahl 500min<sup>-1</sup>)
- ② Bohrer bis zur Tiefe der Pilotbohrung (1DC) bei einem Vorschub von 3000mm/min zurückfahren.
- ③ Fahren Sie den Bohrer anschließend mit einem Vorschub von 0.2–0.3mm/U ganz heraus.

# Notizen

---

A series of horizontal dashed lines for writing notes, spanning the width of the page.

# BOHREN (VOLLHARTMETALL)

# MAE, MAS

- Entwickelt für die Bearbeitung von Aluminium und Guß.
- Hohe Bohrgenauigkeit.
- Bohrungen für Gewindeformer.
- Gedrallte Kühlmittelbohrungen lassen hohe Drehzahlen zu (MAS-Bohrer).



Nur MAS

P M **K** N S H

**MAE** (Externe Kühlung)



**MAS** (Interne Kühlung)



Hinweis 1) MAS-Bohrer größer als Ø 5.0 haben einen Absatz am Bohrerenauslauf.  
Hinweis 2) MAE/MAS-Bohrer eignen sich für die Verwendung mit Schrupfaufnahmen.



DC=3	3<DC≤6	6<DC≤10	10<DC≤16
+0.005 0	+0.005 0	+0.005 0	+0.005 0
0 -0.006	0 -0.008	0 -0.009	0 -0.011

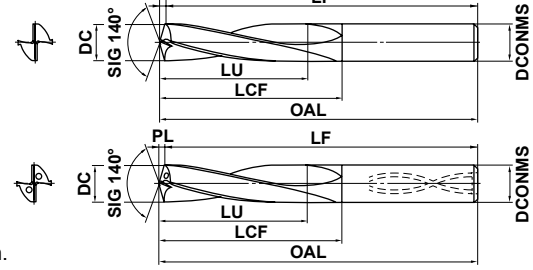

DC (mm)	Bohrtiefe (L/D)	Kühlung (Int./Ext.)	HT10	Bestellnummer	Abmessungen (mm)					
					LU	LCF	OAL	LF	PL	DCONMS
3.0	3	Ext.	★	MAE0300MB	9.5	21.5	61.5	61	0.5	3
	3	Int.	□	MAS0300MB	9.5	21.5	61.5	61	0.5	3
	6	Int.	●	MAS0300LB	18.5	30.5	70.5	70	0.5	3
3.1	3	Ext.	★	MAE0310MB	9.9	24.6	64.6	64	0.6	4
	3	Int.	□	MAS0310MB	9.9	24.6	64.6	64	0.6	4
	6	Int.	★	MAS0310LB	19.2	34.6	74.6	74	0.6	4
3.2	3	Ext.	★	MAE0320MB	10.2	24.6	64.6	64	0.6	4
	3	Int.	□	MAS0320MB	10.2	24.6	64.6	64	0.6	4
	6	Int.	★	MAS0320LB	19.8	34.6	74.6	74	0.6	4
3.3	3	Ext.	★	MAE0330MB	10.5	24.6	64.6	64	0.6	4
	3	Int.	□	MAS0330MB	10.5	24.6	64.6	64	0.6	4
	6	Int.	●	MAS0330LB	20.4	34.6	74.6	74	0.6	4
3.4	3	Ext.	★	MAE0340MB	10.8	24.6	64.6	64	0.6	4
	3	Int.	□	MAS0340MB	10.8	24.6	64.6	64	0.6	4
	6	Int.	★	MAS0340LB	21.0	34.6	74.6	74	0.6	4
3.5	3	Ext.	★	MAE0350MB	11.1	24.6	64.6	64	0.6	4
	3	Int.	□	MAS0350MB	11.1	24.6	64.6	64	0.6	4
	6	Int.	●	MAS0350LB	21.6	34.6	74.6	74	0.6	4
3.6	3	Ext.	★	MAE0360MB	11.5	28.7	68.7	68	0.7	4
	3	Int.	□	MAS0360MB	11.5	28.7	68.7	68	0.7	4
	6	Int.	★	MAS0360LB	22.3	40.7	80.7	80	0.7	4
3.65	3	Ext.	★	* MAE0365MB	11.7	28.7	68.7	68	0.7	4
	3	Int.	□	* MAS0365MB	11.7	28.7	68.7	68	0.7	4
	6	Int.	●	* MAS0365LB	22.6	40.7	80.7	80	0.7	4
3.7	3	Ext.	★	MAE0370MB	11.8	28.7	68.7	68	0.7	4
	3	Int.	□	MAS0370MB	11.8	28.7	68.7	68	0.7	4
	6	Int.	★	MAS0370LB	22.9	40.7	80.7	80	0.7	4
3.8	3	Ext.	★	MAE0380MB	12.1	28.7	68.7	68	0.7	4
	3	Int.	□	MAS0380MB	12.1	28.7	68.7	68	0.7	4
	6	Int.	★	MAS0380LB	23.5	40.7	80.7	80	0.7	4
3.9	3	Ext.	★	MAE0390MB	12.4	28.7	68.7	68	0.7	4
	3	Int.	□	MAS0390MB	12.4	28.7	68.7	68	0.7	4
	6	Int.	★	MAS0390LB	24.1	40.7	80.7	80	0.7	4
4.0	3	Ext.	★	MAE0400MB	12.7	28.7	68.7	68	0.7	4
	3	Int.	□	MAS0400MB	12.7	28.7	68.7	68	0.7	4
	6	Int.	●	MAS0400LB	24.7	40.7	80.7	80	0.7	4
4.1	3	Ext.	★	MAE0410MB	13.0	31.7	71.7	71	0.7	5
	3	Int.	□	MAS0410MB	13.0	31.7	71.7	71	0.7	5
	6	Int.	★	MAS0410LB	25.3	44.7	84.7	84	0.7	5

DC (mm)	Bohrtiefe (L/D)	Kühlung (Int./Ext.)	HT10	Bestellnummer	Abmessungen (mm)					
					LU	LCF	OAL	LF	PL	DCONMS
4.2	3	Ext.	★	MAE0420MB	13.4	31.8	71.8	71	0.8	5
	3	Int.	□	MAS0420MB	13.4	31.8	71.8	71	0.8	5
	6	Int.	●	MAS0420LB	26.0	44.8	84.8	84	0.8	5
4.3	3	Ext.	★	MAE0430MB	13.7	31.8	71.8	71	0.8	5
	3	Int.	□	MAS0430MB	13.7	31.8	71.8	71	0.8	5
	6	Int.	★	MAS0430LB	26.6	44.8	84.8	84	0.8	5
4.4	3	Ext.	★	MAE0440MB	14.0	31.8	71.8	71	0.8	5
	3	Int.	□	MAS0440MB	14.0	31.8	71.8	71	0.8	5
	6	Int.	★	MAS0440LB	27.2	44.8	84.8	84	0.8	5
4.5	3	Ext.	★	MAE0450MB	14.3	31.8	71.8	71	0.8	5
	3	Int.	□	MAS0450MB	14.3	31.8	71.8	71	0.8	5
	6	Int.	★	MAS0450LB	27.8	44.8	84.8	84	0.8	5
4.6	3	Ext.	★	* MAE0460MB	14.6	33.8	73.8	73	0.8	5
	3	Int.	□	* MAS0460MB	14.6	33.8	73.8	73	0.8	5
	6	Int.	●	* MAS0460LB	28.4	48.8	88.8	88	0.8	5
4.7	3	Ext.	★	MAE0470MB	15.0	33.9	73.9	73	0.9	5
	3	Int.	□	MAS0470MB	15.0	33.9	73.9	73	0.9	5
	6	Int.	★	MAS0470LB	29.1	48.9	88.9	88	0.9	5
4.8	3	Ext.	★	MAE0480MB	15.3	33.9	73.9	73	0.9	5
	3	Int.	□	MAS0480MB	15.3	33.9	73.9	73	0.9	5
	6	Int.	★	MAS0480LB	29.7	48.9	88.9	88	0.9	5
4.9	3	Ext.	★	MAE0490MB	15.6	33.9	73.9	73	0.9	5
	3	Int.	□	MAS0490MB	15.6	33.9	73.9	73	0.9	5
	6	Int.	★	MAS0490LB	30.3	48.9	88.9	88	0.9	5
5.0	3	Ext.	★	MAE0500MB	15.9	33.9	73.9	73	0.9	5
	3	Int.	●	MAS0500MB	15.9	33.9	73.9	73	0.9	5
	6	Int.	●	MAS0500LB	30.9	48.9	88.9	88	0.9	5
5.1	3	Ext.	★	MAE0510MB	16.2	36.9	76.9	76	0.9	6
	3	Int.	□	MAS0510MB	16.2	36.9	76.9	76	0.9	6
	6	Int.	★	MAS0510LB	31.5	52.9	92.9	92	0.9	6
5.2	3	Ext.	★	MAE0520MB	16.5	36.9	76.9	76	0.9	6
	3	Int.	□	MAS0520MB	16.5	36.9	76.9	76	0.9	6
	6	Int.	●	MAS0520LB	32.1	52.9	92.9	92	0.9	6
5.3	3	Ext.	★	MAE0530MB	16.9	37.0	77.0	76	1.0	6
	3	Int.	□	MAS0530MB	16.9	37.0	77.0	76	1.0	6
	6	Int.	★	MAS0530LB	32.8	53.0	93.0	92	1.0	6
5.4	3	Ext.	★	MAE0540MB	17.2	37.0	77.0	76	1.0	6
	3	Int.	□	MAS0540MB	17.2	37.0	77.0	76	1.0	6
	6	Int.	★	MAS0540LB	33.4	53.0	93.0	92	1.0	6

\* : Standardbohrung für Gewindeformen.

● : Lagerstandard. ★ : Lagerstandard in Japan.

□ : Herstellung nur auf Anfrage



DC (mm)	Bohrtiefe (L/D)	Kühlung (Int./Ext.)	HTT10	Bestellnummer	Abmessungen (mm)					
					LU	LCF	OAL	LF	PL	DCONMS
5.5	3	Ext.	★	* MAE0550MB	17.5	37.0	77.0	76	1.0	6
	3	Int.	★	* MAS0550MB	17.5	37.0	77.0	76	1.0	6
	6	Int.	●	* MAS0550LB	34.0	53.0	93.0	92	1.0	6
5.6	3	Ext.	★	MAE0560MB	17.8	40.0	80.0	79	1.0	6
	3	Int.	□	MAS0560MB	17.8	40.0	80.0	79	1.0	6
	6	Int.	★	MAS0560LB	34.6	58.0	98.0	97	1.0	6
5.7	3	Ext.	★	MAE0570MB	18.1	40.0	80.0	79	1.0	6
	3	Int.	□	MAS0570MB	18.1	40.0	80.0	79	1.0	6
	6	Int.	★	MAS0570LB	35.2	58.0	98.0	97	1.0	6
5.8	3	Ext.	★	MAE0580MB	18.5	40.1	80.1	79	1.1	6
	3	Int.	□	MAS0580MB	18.5	40.1	80.1	79	1.1	6
	6	Int.	★	MAS0580LB	35.9	58.1	98.1	97	1.1	6
5.9	3	Ext.	★	MAE0590MB	18.8	40.1	80.1	79	1.1	6
	3	Int.	□	MAS0590MB	18.8	40.1	80.1	79	1.1	6
	6	Int.	★	MAS0590LB	36.5	58.1	98.1	97	1.1	6
6.0	3	Ext.	★	MAE0600MB	19.1	40.1	80.1	79	1.1	6
	3	Int.	●	MAS0600MB	19.1	40.1	80.1	79	1.1	6
	6	Int.	●	MAS0600LB	37.1	58.1	98.1	97	1.1	6
6.1	3	Ext.	★	MAE0610MB	19.4	43.1	85.1	84	1.1	7
	3	Int.	□	MAS0610MB	19.4	43.1	85.1	84	1.1	7
	6	Int.	★	MAS0610LB	37.7	63.1	105.1	104	1.1	7
6.2	3	Ext.	★	MAE0620MB	19.7	43.1	85.1	84	1.1	7
	3	Int.	□	MAS0620MB	19.7	43.1	85.1	84	1.1	7
	6	Int.	★	MAS0620LB	38.3	63.1	105.1	104	1.1	7
6.3	3	Ext.	★	MAE0630MB	20.0	43.1	85.1	84	1.1	7
	3	Int.	□	MAS0630MB	20.0	43.1	85.1	84	1.1	7
	6	Int.	★	MAS0630LB	38.9	63.1	105.1	104	1.1	7
6.4	3	Ext.	★	MAE0640MB	20.4	43.2	85.2	84	1.2	7
	3	Int.	□	MAS0640MB	20.4	43.2	85.2	84	1.2	7
	6	Int.	★	MAS0640LB	39.6	63.2	105.2	104	1.2	7
6.5	3	Ext.	★	MAE0650MB	20.7	43.2	85.2	84	1.2	7
	3	Int.	★	MAS0650MB	20.7	43.2	85.2	84	1.2	7
	6	Int.	●	MAS0650LB	40.2	63.2	105.2	104	1.2	7
6.6	3	Ext.	★	MAE0660MB	21.0	43.2	85.2	84	1.2	7
	3	Int.	□	MAS0660MB	21.0	43.2	85.2	84	1.2	7
	6	Int.	★	MAS0660LB	40.8	66.2	108.2	107	1.2	7
6.7	3	Ext.	★	MAE0670MB	21.3	43.2	85.2	84	1.2	7
	3	Int.	□	MAS0670MB	21.3	43.2	85.2	84	1.2	7
	6	Int.	●	MAS0670LB	41.4	66.2	108.2	107	1.2	7
6.8	3	Ext.	★	MAE0680MB	21.6	43.2	85.2	84	1.2	7
	3	Int.	★	MAS0680MB	21.6	43.2	85.2	84	1.2	7
	6	Int.	●	MAS0680LB	42.0	66.2	108.2	107	1.2	7
6.9	3	Ext.	★	MAE0690MB	22.0	43.3	85.3	84	1.3	7
	3	Int.	□	MAS0690MB	22.0	43.3	85.3	84	1.3	7
	6	Int.	★	MAS0690LB	42.7	66.3	108.3	107	1.3	7
7.0	3	Ext.	★	MAE0700MB	22.3	43.3	85.3	84	1.3	7
	3	Int.	★	MAS0700MB	22.3	43.3	85.3	84	1.3	7
	6	Int.	●	MAS0700LB	43.3	66.3	108.3	107	1.3	7

\* : Standardbohrung für Gewindeformen.

DC (mm)	Bohrtiefe (L/D)	Kühlung (Int./Ext.)	HTT10	Bestellnummer	Abmessungen (mm)					
					LU	LCF	OAL	LF	PL	DCONMS
7.1	3	Ext.	★	MAE0710MB	22.6	49.3	91.3	90	1.3	8
	3	Int.	□	MAS0710MB	22.6	49.3	91.3	90	1.3	8
	6	Int.	★	MAS0710LB	43.9	69.3	111.3	110	1.3	8
7.2	3	Ext.	★	MAE0720MB	22.9	49.3	91.3	90	1.3	8
	3	Int.	□	MAS0720MB	22.9	49.3	91.3	90	1.3	8
	6	Int.	★	MAS0720LB	44.5	69.3	111.3	110	1.3	8
7.3	3	Ext.	★	MAE0730MB	23.2	49.3	91.3	90	1.3	8
	3	Int.	□	MAS0730MB	23.2	49.3	91.3	90	1.3	8
	6	Int.	★	MAS0730LB	45.1	69.3	111.3	110	1.3	8
7.35	3	Ext.	★	* MAE0735MB	23.4	49.3	91.3	90	1.3	8
	3	Int.	★	* MAS0735MB	23.4	49.3	91.3	90	1.3	8
	6	Int.	●	* MAS0735LB	45.4	69.3	111.3	110	1.3	8
7.4	3	Ext.	★	MAE0740MB	23.5	49.3	91.3	90	1.3	8
	3	Int.	□	MAS0740MB	23.5	49.3	91.3	90	1.3	8
	6	Int.	★	MAS0740LB	45.7	69.3	111.3	110	1.3	8
7.5	3	Ext.	★	MAE0750MB	23.9	49.4	91.4	90	1.4	8
	3	Int.	□	MAS0750MB	23.9	49.4	91.4	90	1.4	8
	6	Int.	★	MAS0750LB	46.4	69.4	111.4	110	1.4	8
7.6	3	Ext.	★	MAE0760MB	24.2	49.4	91.4	90	1.4	8
	3	Int.	□	MAS0760MB	24.2	49.4	91.4	90	1.4	8
	6	Int.	★	MAS0760LB	47.0	73.4	115.4	114	1.4	8
7.7	3	Ext.	★	MAE0770MB	24.5	49.4	91.4	90	1.4	8
	3	Int.	□	MAS0770MB	24.5	49.4	91.4	90	1.4	8
	6	Int.	★	MAS0770LB	47.6	73.4	115.4	114	1.4	8
7.8	3	Ext.	★	MAE0780MB	24.8	49.4	91.4	90	1.4	8
	3	Int.	□	MAS0780MB	24.8	49.4	91.4	90	1.4	8
	6	Int.	★	MAS0780LB	48.2	73.4	115.4	114	1.4	8
7.9	3	Ext.	★	MAE0790MB	25.1	49.4	91.4	90	1.4	8
	3	Int.	□	MAS0790MB	25.1	49.4	91.4	90	1.4	8
	6	Int.	★	MAS0790LB	48.8	73.4	115.4	114	1.4	8
8.0	3	Ext.	★	MAE0800MB	25.5	49.5	91.5	90	1.5	8
	3	Int.	●	MAS0800MB	25.5	49.5	91.5	90	1.5	8
	6	Int.	●	MAS0800LB	49.5	73.5	115.5	114	1.5	8
8.1	3	Ext.	★	MAE0810MB	25.8	51.5	95.5	94	1.5	9
	3	Int.	□	MAS0810MB	25.8	51.5	95.5	94	1.5	9
	6	Int.	★	MAS0810LB	50.1	76.5	120.5	119	1.5	9
8.2	3	Ext.	★	MAE0820MB	26.1	51.5	95.5	94	1.5	9
	3	Int.	□	MAS0820MB	26.1	51.5	95.5	94	1.5	9
	6	Int.	★	MAS0820LB	50.7	76.5	120.5	119	1.5	9
8.3	3	Ext.	★	MAE0830MB	26.4	51.5	95.5	94	1.5	9
	3	Int.	□	MAS0830MB	26.4	51.5	95.5	94	1.5	9
	6	Int.	★	MAS0830LB	51.3	76.5	120.5	119	1.5	9
8.4	3	Ext.	★	MAE0840MB	26.7	51.5	95.5	94	1.5	9
	3	Int.	□	MAS0840MB	26.7	51.5	95.5	94	1.5	9
	6	Int.	★	MAS0840LB	51.9	76.5	120.5	119	1.5	9
8.5	3	Ext.	★	MAE0850MB	27.0	51.5	95.5	94	1.5	9
	3	Int.	●	MAS0850MB	27.0	51.5	95.5	94	1.5	9
	6	Int.	★	MAS0850LB	52.5	76.5	120.5	119	1.5	9

# MAE, MAS

M  
BOHREN

DC (mm)	Bohrtiefe (L/D)	Kühlung (Int./Ext.)	HTI10	Bestellnummer	Abmessungen (mm)					
					LU	LCF	OAL	LF	PL	DCONMS
8.6	3	Ext.	★	MAE0860MB	27.4	51.6	95.6	94	1.6	9
	3	Int.	□	MAS0860MB	27.4	51.6	95.6	94	1.6	9
	6	Int.	★	MAS0860LB	53.2	78.6	122.6	121	1.6	9
8.7	3	Ext.	★	MAE0870MB	27.7	51.6	95.6	94	1.6	9
	3	Int.	□	MAS0870MB	27.7	51.6	95.6	94	1.6	9
	6	Int.	★	MAS0870LB	53.8	78.6	122.6	121	1.6	9
8.8	3	Ext.	★	MAE0880MB	28.0	51.6	95.6	94	1.6	9
	3	Int.	□	MAS0880MB	28.0	51.6	95.6	94	1.6	9
	6	Int.	★	MAS0880LB	54.4	78.6	122.6	121	1.6	9
8.9	3	Ext.	★	MAE0890MB	28.3	51.6	95.6	94	1.6	9
	3	Int.	□	MAS0890MB	28.3	51.6	95.6	94	1.6	9
	6	Int.	★	MAS0890LB	55.0	78.6	122.6	121	1.6	9
9.0	3	Ext.	★	MAE0900MB	28.6	51.6	95.6	94	1.6	9
	3	Int.	★	MAS0900MB	28.6	51.6	95.6	94	1.6	9
	6	Int.	●	MAS0900LB	55.6	78.6	122.6	121	1.6	9
9.1	3	Ext.	★	MAE0910MB	29.0	54.7	98.7	97	1.7	10
	3	Int.	□	MAS0910MB	29.0	54.7	98.7	97	1.7	10
	6	Int.	★	MAS0910LB	56.3	82.7	126.7	125	1.7	10
9.2	3	Ext.	★	MAE0920MB	29.3	54.7	98.7	97	1.7	10
	3	Int.	□	MAS0920MB	29.3	54.7	98.7	97	1.7	10
	6	Int.	★	MAS0920LB	56.9	82.7	126.7	125	1.7	10
9.21	3	Ext.	★	* MAE0921MB	29.3	54.7	98.7	97	1.7	10
	3	Int.	★	* MAS0921MB	29.3	54.7	98.7	97	1.7	10
	6	Int.	★	* MAS0921LB	57.0	82.7	126.7	125	1.7	10
9.3	3	Ext.	★	MAE0930MB	29.6	54.7	98.7	97	1.7	10
	3	Int.	□	MAS0930MB	29.6	54.7	98.7	97	1.7	10
	6	Int.	★	MAS0930LB	57.5	82.7	126.7	125	1.7	10
9.4	3	Ext.	★	MAE0940MB	29.9	54.7	98.7	97	1.7	10
	3	Int.	□	MAS0940MB	29.9	54.7	98.7	97	1.7	10
	6	Int.	★	MAS0940LB	58.1	82.7	126.7	125	1.7	10
9.5	3	Ext.	★	MAE0950MB	30.2	54.7	98.7	97	1.7	10
	3	Int.	★	MAS0950MB	30.2	54.7	98.7	97	1.7	10
	6	Int.	●	MAS0950LB	58.7	82.7	126.7	125	1.7	10
9.6	3	Ext.	★	MAE0960MB	30.5	54.7	98.7	97	1.7	10
	3	Int.	□	MAS0960MB	30.5	54.7	98.7	97	1.7	10
	6	Int.	★	MAS0960LB	59.3	82.7	126.7	125	1.7	10
9.7	3	Ext.	★	MAE0970MB	30.9	54.8	98.8	97	1.8	10
	3	Int.	□	MAS0970MB	30.9	54.8	98.8	97	1.8	10
	6	Int.	★	MAS0970LB	60.0	82.8	126.8	125	1.8	10
9.8	3	Ext.	★	MAE0980MB	31.2	54.8	98.8	97	1.8	10
	3	Int.	□	MAS0980MB	31.2	54.8	98.8	97	1.8	10
	6	Int.	★	MAS0980LB	60.6	82.8	126.8	125	1.8	10
9.9	3	Ext.	★	MAE0990MB	31.5	54.8	98.8	97	1.8	10
	3	Int.	□	MAS0990MB	31.5	54.8	98.8	97	1.8	10
	6	Int.	★	MAS0990LB	61.2	82.8	126.8	125	1.8	10
10.0	3	Ext.	★	MAE1000MB	31.8	54.8	98.8	97	1.8	10
	3	Int.	●	MAS1000MB	31.8	54.8	98.8	97	1.8	10
	6	Int.	●	MAS1000LB	61.8	82.8	126.8	125	1.8	10

\* : Standardbohrung für Gewindeformen.

DC (mm)	Bohrtiefe (L/D)	Kühlung (Int./Ext.)	HTI10	Bestellnummer	Abmessungen (mm)					
					LU	LCF	OAL	LF	PL	DCONMS
10.1	3	Ext.	□	MAE1010MB	32.1	56.8	102.8	101	1.8	11
	3	Int.	□	MAS1010MB	32.1	56.8	102.8	101	1.8	11
	6	Int.	□	MAS1010LB	62.4	90.8	136.8	135	1.8	11
10.2	3	Ext.	□	MAE1020MB	32.5	56.9	102.9	101	1.9	11
	3	Int.	□	MAS1020MB	32.5	56.9	102.9	101	1.9	11
	6	Int.	□	MAS1020LB	63.1	90.9	136.9	135	1.9	11
10.3	3	Ext.	★	MAE1030MB	32.8	56.9	102.9	101	1.9	11
	3	Int.	★	MAS1030MB	32.8	56.9	102.9	101	1.9	11
	6	Int.	●	MAS1030LB	63.7	90.9	136.9	135	1.9	11
10.4	3	Ext.	□	MAE1040MB	33.1	56.9	102.9	101	1.9	11
	3	Int.	□	MAS1040MB	33.1	56.9	102.9	101	1.9	11
	6	Int.	□	MAS1040LB	64.3	90.9	136.9	135	1.9	11
10.5	3	Ext.	★	MAE1050MB	33.4	56.9	102.9	101	1.9	11
	3	Int.	★	MAS1050MB	33.4	56.9	102.9	101	1.9	11
	6	Int.	●	MAS1050LB	64.9	90.9	136.9	135	1.9	11
10.6	3	Ext.	□	MAE1060MB	33.7	56.9	102.9	101	1.9	11
	3	Int.	□	MAS1060MB	33.7	56.9	102.9	101	1.9	11
	6	Int.	□	MAS1060LB	65.5	90.9	136.9	135	1.9	11
10.7	3	Ext.	□	MAE1070MB	34.0	56.9	102.9	101	1.9	11
	3	Int.	□	MAS1070MB	34.0	56.9	102.9	101	1.9	11
	6	Int.	□	MAS1070LB	66.1	90.9	136.9	135	1.9	11
10.8	3	Ext.	□	MAE1080MB	34.4	57.0	103.0	101	2.0	11
	3	Int.	□	MAS1080MB	34.4	57.0	103.0	101	2.0	11
	6	Int.	□	MAS1080LB	66.8	91.0	137.0	135	2.0	11
10.9	3	Ext.	□	MAE1090MB	34.7	57.0	103.0	101	2.0	11
	3	Int.	□	MAS1090MB	34.7	57.0	103.0	101	2.0	11
	6	Int.	□	MAS1090LB	67.4	91.0	137.0	135	2.0	11
11.0	3	Ext.	★	MAE1100MB	35.0	57.0	103.0	101	2.0	11
	3	Int.	★	MAS1100MB	35.0	57.0	103.0	101	2.0	11
	6	Int.	●	MAS1100LB	68.0	91.0	137.0	135	2.0	11
11.08	3	Ext.	★	* MAE1108MB	35.2	62.0	108.0	106	2.0	12
	3	Int.	★	* MAS1108MB	35.2	62.0	108.0	106	2.0	12
	6	Int.	●	* MAS1108LB	68.5	96.0	142.0	140	2.0	12
11.1	3	Ext.	□	MAE1110MB	35.3	62.0	108.0	106	2.0	12
	3	Int.	□	MAS1110MB	35.3	62.0	108.0	106	2.0	12
	6	Int.	□	MAS1110LB	68.6	96.0	142.0	140	2.0	12
11.2	3	Ext.	□	MAE1120MB	35.6	62.0	108.0	106	2.0	12
	3	Int.	□	MAS1120MB	35.6	62.0	108.0	106	2.0	12
	6	Int.	□	MAS1120LB	69.2	96.0	142.0	140	2.0	12
11.3	3	Ext.	□	MAE1130MB	36.0	62.1	108.1	106	2.1	12
	3	Int.	□	MAS1130MB	36.0	62.1	108.1	106	2.1	12
	6	Int.	□	MAS1130LB	69.9	96.1	142.1	140	2.1	12
11.4	3	Ext.	□	MAE1140MB	36.3	62.1	108.1	106	2.1	12
	3	Int.	□	MAS1140MB	36.3	62.1	108.1	106	2.1	12
	6	Int.	□	MAS1140LB	70.5	96.1	142.1	140	2.1	12
11.5	3	Ext.	□	MAE1150MB	36.6	62.1	108.1	106	2.1	12
	3	Int.	□	MAS1150MB	36.6	62.1	108.1	106	2.1	12
	6	Int.	□	MAS1150LB	71.1	96.1	142.1	140	2.1	12

● : Lagerstandard. ★ : Lagerstandard in Japan.

□ : Herstellung nur auf Anfrage

DC (mm)	Bohrtiefe (L/D)	Kühlung (Int./Ext.)	HTI10	Bestellnummer	Abmessungen (mm)					
					LU	LCF	OAL	LF	PL	DCONMS
11.6	3	Ext.	□	MAE1160MB	36.9	62.1	108.1	106	2.1	12
	3	Int.	□	MAS1160MB	36.9	62.1	108.1	106	2.1	12
	6	Int.	□	MAS1160LB	71.7	96.1	142.1	140	2.1	12
11.7	3	Ext.	□	MAE1170MB	37.2	62.1	108.1	106	2.1	12
	3	Int.	□	MAS1170MB	37.2	62.1	108.1	106	2.1	12
	6	Int.	□	MAS1170LB	72.3	96.1	142.1	140	2.1	12
11.8	3	Ext.	□	MAE1180MB	37.5	62.1	108.1	106	2.1	12
	3	Int.	□	MAS1180MB	37.5	62.1	108.1	106	2.1	12
	6	Int.	□	MAS1180LB	72.9	96.1	142.1	140	2.1	12
11.9	3	Ext.	□	MAE1190MB	37.9	62.2	108.2	106	2.2	12
	3	Int.	□	MAS1190MB	37.9	62.2	108.2	106	2.2	12
	6	Int.	□	MAS1190LB	73.6	96.2	142.2	140	2.2	12
12.0	3	Ext.	★	MAE1200MB	38.2	62.2	108.2	106	2.2	12
	3	Int.	●	MAS1200MB	38.2	62.2	108.2	106	2.2	12
	6	Int.	●	MAS1200LB	74.2	96.2	142.2	140	2.2	12
12.1	3	Ext.	□	MAE1210MB	38.5	67.2	117.2	115	2.2	13
	3	Int.	□	MAS1210MB	38.5	67.2	117.2	115	2.2	13
	6	Int.	□	MAS1210LB	74.8	102.2	152.2	150	2.2	13
12.2	3	Ext.	□	MAE1220MB	38.8	67.2	117.2	115	2.2	13
	3	Int.	□	MAS1220MB	38.8	67.2	117.2	115	2.2	13
	6	Int.	□	MAS1220LB	75.4	102.2	152.2	150	2.2	13
12.3	3	Ext.	□	MAE1230MB	39.1	67.2	117.2	115	2.2	13
	3	Int.	□	MAS1230MB	39.1	67.2	117.2	115	2.2	13
	6	Int.	□	MAS1230LB	76.0	102.2	152.2	150	2.2	13
12.4	3	Ext.	□	MAE1240MB	39.5	67.3	117.3	115	2.3	13
	3	Int.	□	MAS1240MB	39.5	67.3	117.3	115	2.3	13
	6	Int.	□	MAS1240LB	76.7	102.3	152.3	150	2.3	13
12.5	3	Ext.	★	MAE1250MB	39.8	67.3	117.3	115	2.3	13
	3	Int.	●	MAS1250MB	39.8	67.3	117.3	115	2.3	13
	6	Int.	●	MAS1250LB	77.3	102.3	152.3	150	2.3	13
12.6	3	Ext.	□	MAE1260MB	40.1	67.3	117.3	115	2.3	13
	3	Int.	□	MAS1260MB	40.1	67.3	117.3	115	2.3	13
	6	Int.	□	MAS1260LB	77.9	102.3	152.3	150	2.3	13
12.7	3	Ext.	□	MAE1270MB	40.4	67.3	117.3	115	2.3	13
	3	Int.	□	MAS1270MB	40.4	67.3	117.3	115	2.3	13
	6	Int.	□	MAS1270LB	78.5	102.3	152.3	150	2.3	13
12.8	3	Ext.	□	MAE1280MB	40.7	67.3	117.3	115	2.3	13
	3	Int.	□	MAS1280MB	40.7	67.3	117.3	115	2.3	13
	6	Int.	□	MAS1280LB	79.1	102.3	152.3	150	2.3	13
12.9	3	Ext.	□	MAE1290MB	41.0	67.3	117.3	115	2.3	13
	3	Int.	□	MAS1290MB	41.0	67.3	117.3	115	2.3	13
	6	Int.	□	MAS1290LB	79.7	102.3	152.3	150	2.3	13
12.96	3	Ext.	★	*MAE1296MB	41.3	67.4	117.4	115	2.4	13
	3	Int.	★	*MAS1296MB	41.3	67.4	117.4	115	2.4	13
	6	Int.	★	*MAS1296LB	80.2	102.4	152.4	150	2.4	13
13.0	3	Ext.	★	MAE1300MB	41.4	67.4	117.4	115	2.4	13
	3	Int.	★	MAS1300MB	41.4	67.4	117.4	115	2.4	13
	6	Int.	●	MAS1300LB	80.4	102.4	152.4	150	2.4	13

\* : Standardbohrung für Gewindeformen.

DC (mm)	Bohrtiefe (L/D)	Kühlung (Int./Ext.)	HTI10	Bestellnummer	Abmessungen (mm)					
					LU	LCF	OAL	LF	PL	DCONMS
13.1	3	Ext.	□	MAE1310MB	41.7	72.4	122.4	120	2.4	14
	3	Int.	□	MAS1310MB	41.7	72.4	122.4	120	2.4	14
	6	Int.	□	MAS1310LB	81.0	112.4	162.4	160	2.4	14
13.2	3	Ext.	□	MAE1320MB	42.0	72.4	122.4	120	2.4	14
	3	Int.	□	MAS1320MB	42.0	72.4	122.4	120	2.4	14
	6	Int.	□	MAS1320LB	81.6	112.4	162.4	160	2.4	14
13.3	3	Ext.	□	MAE1330MB	42.3	72.4	122.4	120	2.4	14
	3	Int.	□	MAS1330MB	42.3	72.4	122.4	120	2.4	14
	6	Int.	□	MAS1330LB	82.2	112.4	162.4	160	2.4	14
13.4	3	Ext.	□	MAE1340MB	42.6	72.4	122.4	120	2.4	14
	3	Int.	□	MAS1340MB	42.6	72.4	122.4	120	2.4	14
	6	Int.	□	MAS1340LB	82.8	112.4	162.4	160	2.4	14
13.5	3	Ext.	★	MAE1350MB	43.0	72.5	122.5	120	2.5	14
	3	Int.	★	MAS1350MB	43.0	72.5	122.5	120	2.5	14
	6	Int.	★	MAS1350LB	83.5	112.5	162.5	160	2.5	14
13.6	3	Ext.	□	MAE1360MB	43.3	72.5	122.5	120	2.5	14
	3	Int.	□	MAS1360MB	43.3	72.5	122.5	120	2.5	14
	6	Int.	□	MAS1360LB	84.1	112.5	162.5	160	2.5	14
13.7	3	Ext.	□	MAE1370MB	43.6	72.5	122.5	120	2.5	14
	3	Int.	□	MAS1370MB	43.6	72.5	122.5	120	2.5	14
	6	Int.	□	MAS1370LB	84.7	112.5	162.5	160	2.5	14
13.8	3	Ext.	□	MAE1380MB	43.9	72.5	122.5	120	2.5	14
	3	Int.	□	MAS1380MB	43.9	72.5	122.5	120	2.5	14
	6	Int.	□	MAS1380LB	85.3	112.5	162.5	160	2.5	14
13.9	3	Ext.	□	MAE1390MB	44.2	72.5	122.5	120	2.5	14
	3	Int.	□	MAS1390MB	44.2	72.5	122.5	120	2.5	14
	6	Int.	□	MAS1390LB	85.9	112.5	162.5	160	2.5	14
14.0	3	Ext.	★	MAE1400MB	44.5	72.5	122.5	120	2.5	14
	3	Int.	●	MAS1400MB	44.5	72.5	122.5	120	2.5	14
	6	Int.	●	MAS1400LB	86.5	112.5	162.5	160	2.5	14
14.1	3	Ext.	□	MAE1410MB	44.9	74.6	132.6	130	2.6	15
	3	Int.	□	MAS1410MB	44.9	74.6	132.6	130	2.6	15
	6	Int.	□	MAS1410LB	87.2	117.6	175.6	173	2.6	15
14.2	3	Ext.	□	MAE1420MB	45.2	74.6	132.6	130	2.6	15
	3	Int.	□	MAS1420MB	45.2	74.6	132.6	130	2.6	15
	6	Int.	□	MAS1420LB	87.8	117.6	175.6	173	2.6	15
14.3	3	Ext.	□	MAE1430MB	45.5	74.6	132.6	130	2.6	15
	3	Int.	□	MAS1430MB	45.5	74.6	132.6	130	2.6	15
	6	Int.	□	MAS1430LB	88.4	117.6	175.6	173	2.6	15
14.4	3	Ext.	□	MAE1440MB	45.8	74.6	132.6	130	2.6	15
	3	Int.	□	MAS1440MB	45.8	74.6	132.6	130	2.6	15
	6	Int.	□	MAS1440LB	89.0	117.6	175.6	173	2.6	15
14.5	3	Ext.	□	MAE1450MB	46.1	74.6	132.6	130	2.6	15
	3	Int.	□	MAS1450MB	46.1	74.6	132.6	130	2.6	15
	6	Int.	□	MAS1450LB	89.6	117.6	175.6	173	2.6	15
14.6	3	Ext.	□	MAE1460MB	46.5	74.7	132.7	130	2.7	15
	3	Int.	□	MAS1460MB	46.5	74.7	132.7	130	2.7	15
	6	Int.	□	MAS1460LB	90.3	117.7	175.7	173	2.7	15

# MAE, MAS

M

BOHREN

DC (mm)	Bohrtiefe (L/D)	Kühlung (Int./Ext.)	HT110	Bestellnummer	Abmessungen (mm)					
					LU	LCF	OAL	LF	PL	DCONMS
14.7	3	Ext.	<input type="checkbox"/>	MAE1470MB	46.8	74.7	132.7	130	2.7	15
	3	Int.	<input type="checkbox"/>	MAS1470MB	46.8	74.7	132.7	130	2.7	15
	6	Int.	<input type="checkbox"/>	MAS1470LB	90.9	117.7	175.7	173	2.7	15
14.8	3	Ext.	<input type="checkbox"/>	MAE1480MB	47.1	74.7	132.7	130	2.7	15
	3	Int.	<input type="checkbox"/>	MAS1480MB	47.1	74.7	132.7	130	2.7	15
	6	Int.	<input type="checkbox"/>	MAS1480LB	91.5	117.7	175.7	173	2.7	15
14.9	3	Ext.	<input type="checkbox"/>	MAE1490MB	47.4	74.7	132.7	130	2.7	15
	3	Int.	<input type="checkbox"/>	MAS1490MB	47.4	74.7	132.7	130	2.7	15
	6	Int.	<input type="checkbox"/>	MAS1490LB	92.1	117.7	175.7	173	2.7	15
14.96	3	Ext.	★	*MAE1496MB	47.6	74.7	132.7	130	2.7	15
	3	Int.	★	*MAS1496MB	47.6	74.7	132.7	130	2.7	15
	6	Int.	★	*MAS1496LB	92.5	117.7	175.7	173	2.7	15
15.0	3	Ext.	★	MAE1500MB	47.7	74.7	132.7	130	2.7	15
	3	Int.	★	MAS1500MB	47.7	74.7	132.7	130	2.7	15
	6	Int.	●	MAS1500LB	92.7	117.7	175.7	173	2.7	15
15.1	3	Ext.	<input type="checkbox"/>	MAE1510MB	48.0	78.7	136.7	134	2.7	16
	3	Int.	<input type="checkbox"/>	MAS1510MB	48.0	78.7	136.7	134	2.7	16
	6	Int.	<input type="checkbox"/>	MAS1510LB	93.3	122.7	180.7	178	2.7	16
15.2	3	Ext.	<input type="checkbox"/>	MAE1520MB	48.4	78.8	136.8	134	2.8	16
	3	Int.	<input type="checkbox"/>	MAS1520MB	48.4	78.8	136.8	134	2.8	16
	6	Int.	<input type="checkbox"/>	MAS1520LB	94.0	122.8	180.8	178	2.8	16
15.3	3	Ext.	<input type="checkbox"/>	MAE1530MB	48.7	78.8	136.8	134	2.8	16
	3	Int.	<input type="checkbox"/>	MAS1530MB	48.7	78.8	136.8	134	2.8	16
	6	Int.	<input type="checkbox"/>	MAS1530LB	94.6	122.8	180.8	178	2.8	16
15.4	3	Ext.	<input type="checkbox"/>	MAE1540MB	49.0	78.8	136.8	134	2.8	16
	3	Int.	<input type="checkbox"/>	MAS1540MB	49.0	78.8	136.8	134	2.8	16
	6	Int.	<input type="checkbox"/>	MAS1540LB	95.2	122.8	180.8	178	2.8	16
15.5	3	Ext.	<input type="checkbox"/>	MAE1550MB	49.3	78.8	136.8	134	2.8	16
	3	Int.	<input type="checkbox"/>	MAS1550MB	49.3	78.8	136.8	134	2.8	16
	6	Int.	<input type="checkbox"/>	MAS1550LB	95.8	122.8	180.8	178	2.8	16
15.6	3	Ext.	<input type="checkbox"/>	MAE1560MB	49.6	78.8	136.8	134	2.8	16
	3	Int.	<input type="checkbox"/>	MAS1560MB	49.6	78.8	136.8	134	2.8	16
	6	Int.	<input type="checkbox"/>	MAS1560LB	96.4	122.8	180.8	178	2.8	16
15.7	3	Ext.	<input type="checkbox"/>	MAE1570MB	50.0	78.9	136.9	134	2.9	16
	3	Int.	<input type="checkbox"/>	MAS1570MB	50.0	78.9	136.9	134	2.9	16
	6	Int.	<input type="checkbox"/>	MAS1570LB	97.1	122.9	180.9	178	2.9	16
15.8	3	Ext.	<input type="checkbox"/>	MAE1580MB	50.3	78.9	136.9	134	2.9	16
	3	Int.	<input type="checkbox"/>	MAS1580MB	50.3	78.9	136.9	134	2.9	16
	6	Int.	<input type="checkbox"/>	MAS1580LB	97.7	122.9	180.9	178	2.9	16
15.9	3	Ext.	<input type="checkbox"/>	MAE1590MB	50.6	78.9	136.9	134	2.9	16
	3	Int.	<input type="checkbox"/>	MAS1590MB	50.6	78.9	136.9	134	2.9	16
	6	Int.	<input type="checkbox"/>	MAS1590LB	98.3	122.9	180.9	178	2.9	16
16.0	3	Ext.	★	MAE1600MB	50.9	78.9	136.9	134	2.9	16
	3	Int.	★	MAS1600MB	50.9	78.9	136.9	134	2.9	16
	6	Int.	●	MAS1600LB	98.9	122.9	180.9	178	2.9	16

\* : Standardbohrung für Gewindeformen.

● : Lagerstandard. ★ : Lagerstandard in Japan.

□ : Herstellung nur auf Anfrage

## SCHNITTDATENEMPFEHLUNGEN

Typ	Material	Bohrer Durchm. $\varnothing$ 3.0– $\varnothing$ 6.0		Bohrer Durchm. $\varnothing$ 6.1– $\varnothing$ 10.0		Bohrer Durchm. $\varnothing$ 10.1– $\varnothing$ 16.0	
		Schnittgeschw. (m/min)	Vorschub (mm/U.)	Schnittgeschw. (m/min)	Vorschub (mm/U.)	Schnittgeschw. (m/min)	Vorschub (mm/U.)
MAE	N Aluminiumleg.	90 (40–140)	0.15 (0.05–0.3)	100 (50–150)	0.2 (0.1–0.3)	120 (60–170)	0.25 (0.1–0.4)
	Aluminiumgusslegierung	100 (60–150)	0.12 (0.05–0.25)	110 (70–160)	0.15 (0.05–0.25)	130 (80–180)	0.2 (0.1–0.3)
	K Grauguss	40 (20–60)	0.15 (0.1–0.2)	60 (40–80)	0.2 (0.1–0.3)	80 (60–100)	0.3 (0.2–0.4)
	Duktiler Guss	30 (20–40)	0.1 (0.05–0.15)	40 (20–60)	0.12 (0.05–0.2)	60 (40–80)	0.2 (0.1–0.3)
MAS	N Aluminiumleg.	100 (60–150)	0.15 (0.05–0.3)	120 (80–170)	0.2 (0.1–0.3)	150 (100–200)	0.25 (0.1–0.4)
	Aluminiumgusslegierung	120 (80–170)	0.12 (0.05–0.25)	150 (100–180)	0.15 (0.05–0.25)	160 (120–200)	0.2 (0.1–0.3)
	K Grauguss	60 (40–80)	0.15 (0.1–0.2)	80 (60–110)	0.2 (0.1–0.3)	100 (70–130)	0.3 (0.2–0.4)
	Duktiler Guss	45 (30–60)	0.1 (0.05–0.15)	60 (40–80)	0.12 (0.05–0.2)	80 (60–100)	0.2 (0.1–0.3)

## LOCH- UND BOHRDURCHMESSER FÜR GEWINDEBOHREN

Gewindegröße	Gewindebohren			Gewindeformen		
	Bohrer Durchm. (DC)	Toleranz der Lochdurchmesser		Bohrer Durchm. (DC)	Toleranz der Lochdurchmesser	
		min	max		min	max
<b>M4x0.7</b>	<b>3.3</b>	3.242	3.422	<b>3.65</b>	3.65	3.70
<b>M5x0.8</b>	<b>4.2</b>	4.134	4.334	<b>4.60</b>	4.59	4.66
<b>M6x1.0</b>	<b>5.0</b>	4.917	5.153	<b>5.50</b>	5.48	5.57
<b>M8x1.25</b>	<b>6.8</b>	6.647	6.912	<b>7.35</b>	7.34	7.41
<b>M10x1.5</b>	<b>8.5</b>	8.376	8.676	<b>9.21</b>	9.18	9.28
<b>M12x1.75</b>	<b>10.3</b>	10.106	10.441	<b>11.08</b>	11.05	11.15
<b>M14x2</b>	<b>12.0</b>	11.835	12.210	<b>12.96</b>	12.92	13.04
<b>M16x2</b>	<b>14.0</b>	13.835	14.210	<b>14.96</b>	14.92	15.04

# BOHREN (VOLLHARTMETALL)

# MHS

- Verstärkte Geometrie mit 4 Führungsfasen für eine prozesssichere Bearbeitung.
- Für das Tieflochbohren ohne Lüften in gehärteten Werkstoffen.



Interne Kühlung



M

BOHREN

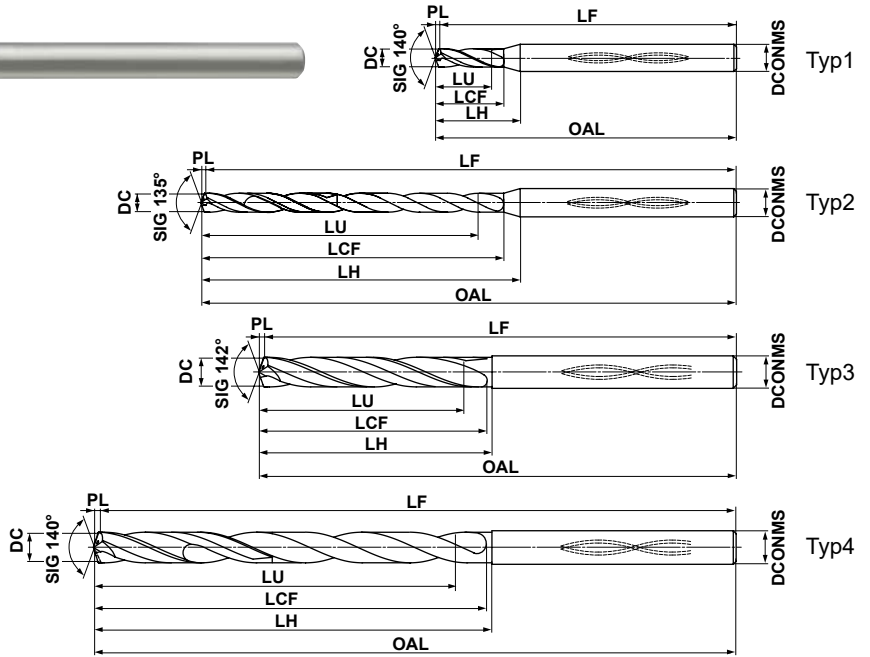

	DC ≤ 3	3 < DC ≤ 6	6 < DC ≤ 10	10 < DC ≤ 12
	+0.010 -0.002	+0.010 -0.002	+0.010 -0.005	+0.010 -0.008
	DCONMS=3	3 < DCONMS ≤ 6	6 < DCONMS ≤ 10	10 < DCONMS ≤ 12
	0 -0.006	0 -0.008	0 -0.009	0 -0.011

- Die MHS-Bohrer eignen sich für die Verwendung mit Schrumpfaufnahmen.
- Verwenden Sie den kürzesten Bohrer im gleichen Durchmesser als Pilotbohrer.

DC (mm)	Bohr- tiefe (L/D)	VP15TF	Bestellnummer	Abmessungen (mm)							Typ
				LU	LCF	LH	OAL	LF	PL	DCONMS	
0.95	3	★	MHS0095L006B	3.0	6.2	10.0	60.2	60	0.17	3	1
	6	★	MHS0095L009B	5.9	9.2	13.0	60.2	60	0.17	3	2
	13	★	MHS0095L015B	12.5	15.2	19.0	60.2	60	0.17	3	2
	23	★	MHS0095L025B	22.0	25.2	29.0	60.2	60	0.17	3	2
	30	★	MHS0095L035B	28.7	35.2	39.0	80.2	80	0.17	3	2
1.00	3	●	MHS0100L006B	3.2	6.2	9.9	60.2	60	0.2	3	1
	6	●	MHS0100L009B	6.2	9.2	12.9	60.2	60	0.2	3	2
	12	★	MHS0100L015B	12.2	15.2	18.9	60.2	60	0.2	3	2
	22	●	MHS0100L025B	22.2	25.2	28.9	60.2	60	0.2	3	2
	30	●	MHS0100L035B	30.2	35.2	38.9	80.2	80	0.2	3	2
1.10	2	●	MHS0110L006B	2.4	6.2	9.7	60.2	60	0.2	3	1
	5	★	MHS0110L009B	5.7	9.2	12.7	60.2	60	0.2	3	2
	11	●	MHS0110L015B	12.3	15.2	18.7	60.2	60	0.2	3	2
	20	●	MHS0110L025B	22.2	25.2	28.7	60.2	60	0.2	3	2
	29	●	MHS0110L035B	32.1	35.2	38.7	80.2	80	0.2	3	2
1.20	2	●	MHS0120L006B	2.6	6.2	9.6	60.2	60	0.2	3	1
	5	★	MHS0120L009B	6.2	9.2	12.6	60.2	60	0.2	3	2
	10	●	MHS0120L015B	12.2	15.2	18.6	60.2	60	0.2	3	2
	18	●	MHS0120L025B	21.8	25.2	28.6	60.2	60	0.2	3	2
	26	●	MHS0120L035B	31.4	35.2	38.6	80.2	80	0.2	3	2
1.30	2	●	MHS0130L007B	2.8	7.2	10.4	60.2	60	0.2	3	1
	5	★	MHS0130L011B	6.8	11.3	14.5	60.3	60	0.3	3	2
	12	●	MHS0130L020B	15.9	20.3	23.5	60.3	60	0.3	3	2
	20	●	MHS0130L030B	26.3	30.3	33.5	80.3	80	0.3	3	2
	30	●	MHS0130L045B	39.3	45.3	48.5	80.3	80	0.3	3	2

DC (mm)	Bohr- tiefe (L/D)	VP15TF	Bestellnummer	Abmessungen (mm)							Typ
				LU	LCF	LH	OAL	LF	PL	DCONMS	
1.40	2	●	MHS0140L007B	3.1	7.3	10.3	60.3	60	0.3	3	1
	5	★	MHS0140L011B	7.3	11.3	14.3	60.3	60	0.3	3	2
	11	●	MHS0140L020B	15.7	20.3	23.3	60.3	60	0.3	3	2
	18	★	MHS0140L030B	25.5	30.3	33.3	80.3	80	0.3	3	2
	29	★	MHS0140L045B	40.9	45.3	48.3	80.3	80	0.3	3	2
1.45	3	●	MHS0145L008B	4.7	8.3	11.2	60.3	60	0.3	3	1
	6	★	MHS0145L013B	9.0	13.3	16.2	60.3	60	0.3	3	2
	11	★	MHS0145L020B	16.3	20.3	23.2	60.3	60	0.3	3	2
	21	●	MHS0145L035B	30.8	35.3	38.2	80.3	80	0.3	3	2
	30	★	MHS0145L055B	43.8	55.3	58.2	100.3	100	0.3	3	2
1.50	2	●	MHS0150L008B	3.3	8.3	11.1	60.3	60	0.3	3	1
	6	★	MHS0150L013B	9.3	13.3	16.1	60.3	60	0.3	3	2
	10	●	MHS0150L020B	15.3	20.3	23.1	60.3	60	0.3	3	2
	20	●	MHS0150L035B	30.3	35.3	38.1	80.3	80	0.3	3	2
	30	●	MHS0150L055B	45.3	55.3	58.1	100.3	100	0.3	3	2
1.60	2	●	MHS0160L008B	3.5	8.3	10.9	60.3	60	0.3	3	1
	5	★	MHS0160L013B	8.3	13.3	15.9	60.3	60	0.3	3	2
	10	●	MHS0160L020B	16.3	20.3	22.9	60.3	60	0.3	3	2
	19	●	MHS0160L035B	30.7	35.3	37.9	80.3	80	0.3	3	2
	30	●	MHS0160L055B	48.3	55.3	57.9	100.3	100	0.3	3	2
1.70	2	●	MHS0170L008B	3.7	8.3	10.7	60.3	60	0.3	3	1
	5	★	MHS0170L013B	8.9	13.4	15.8	60.4	60	0.4	3	2
	9	●	MHS0170L020B	15.7	20.4	22.8	60.4	60	0.4	3	2
	18	●	MHS0170L035B	31.0	35.4	37.8	80.4	80	0.4	3	2
	29	●	MHS0170L055B	49.7	55.4	57.8	100.4	100	0.4	3	2

Hinweis 1) Bei Bedarf von abweichenden Geometrien setzen Sie sich mit uns in Verbindung.  
(Andere Durchmesser und Längen können bestellt werden).

● : Lagerstandard. ★ : Lagerstandard in Japan.

□ : Herstellung nur auf Anfrage

DC	Bohrtiefe (mm)	VP15TF	Bestellnummer	Abmessungen (mm)								Typ
				LU	LCF	LH	OAL	LF	PL	DCNMMS		
1.80	3	●	MHS0180L010B	5.7	10.3	12.5	60.3	60	0.3	3	1	
	5	★	MHS0180L015B	9.4	15.4	17.6	60.4	60	0.4	3	2	
	11	●	MHS0180L025B	20.2	25.4	27.6	60.4	60	0.4	3	2	
	22	●	MHS0180L045B	40.0	45.4	47.6	80.4	80	0.4	3	2	
	30	●	MHS0180L065B	54.4	65.4	67.6	100.4	100	0.4	3	2	
1.90	2	●	MHS0190L010B	4.1	10.3	12.4	60.3	60	0.3	3	1	
	5	★	MHS0190L015B	9.9	15.4	17.5	60.4	60	0.4	3	2	
	10	●	MHS0190L025B	19.4	25.4	27.5	60.4	60	0.4	3	2	
	21	●	MHS0190L045B	40.3	45.4	47.5	80.4	80	0.4	3	2	
	30	●	MHS0190L065B	57.4	65.4	67.5	100.4	100	0.4	3	2	
1.95	2	●	MHS0195L010B	4.3	10.4	12.4	60.4	60	0.4	3	1	
	5	★	MHS0195L015B	10.2	15.4	17.4	60.4	60	0.4	3	2	
	10	★	MHS0195L025B	19.9	25.4	27.4	60.4	60	0.4	3	2	
	20	●	MHS0195L045B	39.4	45.4	47.4	80.4	80	0.4	3	2	
	30	★	MHS0195L065B	58.9	65.4	67.4	100.4	100	0.4	3	2	
2.00	2	●	MHS0200L010B	4.4	10.4	12.3	60.4	60	0.4	3	1	
	5	★	MHS0200L015B	10.4	15.4	17.3	60.4	60	0.4	3	2	
	9	●	MHS0200L025B	18.4	25.4	27.3	60.4	60	0.4	3	2	
	20	●	MHS0200L045B	40.4	45.4	47.3	80.4	80	0.4	3	2	
	30	●	MHS0200L065B	60.4	65.4	67.3	100.4	100	0.4	3	2	
2.10	3	●	MHS0210L012B	6.7	12.4	14.1	60.4	60	0.4	3	1	
	7	★	MHS0210L020B	15.1	20.4	22.1	60.4	60	0.4	3	2	
	11	●	MHS0210L030B	23.5	30.4	32.1	80.4	80	0.4	3	2	
	23	●	MHS0210L055B	48.7	55.4	57.1	100.4	100	0.4	3	2	
	30	●	MHS0210L075B	63.4	75.4	77.1	120.4	120	0.4	3	2	
2.20	2	●	MHS0220L012B	4.8	12.4	13.9	60.4	60	0.4	3	1	
	6	★	MHS0220L020B	13.7	20.5	22.0	60.5	60	0.5	3	2	
	11	●	MHS0220L030B	24.7	30.5	32.0	80.5	80	0.5	3	2	
	22	●	MHS0220L055B	48.9	55.5	57.0	100.5	100	0.5	3	2	
	30	●	MHS0220L075B	66.5	75.5	77.0	120.5	120	0.5	3	2	
2.30	2	●	MHS0230L012B	5.0	12.4	13.7	60.4	60	0.4	3	1	
	6	★	MHS0230L020B	14.3	20.5	21.8	60.5	60	0.5	3	2	
	10	●	MHS0230L030B	23.5	30.5	31.8	80.5	80	0.5	3	2	
	21	●	MHS0230L055B	48.8	55.5	56.8	100.5	100	0.5	3	2	
	30	●	MHS0230L075B	69.5	75.5	76.8	120.5	120	0.5	3	2	
2.40	2	●	MHS0240L012B	5.2	12.4	13.5	60.4	60	0.4	3	1	
	5	★	MHS0240L020B	12.5	20.5	21.6	60.5	60	0.5	3	2	
	9	●	MHS0240L030B	22.1	30.5	31.6	80.5	80	0.5	3	2	
	20	●	MHS0240L055B	48.5	55.5	56.6	100.5	100	0.5	3	2	
	28	●	MHS0240L075B	67.7	75.5	76.6	120.5	120	0.5	3	2	
2.45	2	★	MHS0245L013B	5.3	13.4	14.4	70.4	70	0.4	4	1	
	5	★	MHS0245L020B	12.8	20.5	21.5	70.5	70	0.5	4	2	
	11	★	MHS0245L035B	27.5	35.5	36.5	90.5	90	0.5	4	2	
	24	★	MHS0245L065B	59.3	65.5	66.5	110.5	110	0.5	4	2	
	30	★	MHS0245L090B	74.0	90.5	91.5	140.5	140	0.5	4	2	
2.50	2	●	MHS0250L013B	5.5	13.5	16.3	70.5	70	0.5	4	1	
	5	★	MHS0250L020B	13.0	20.5	23.3	70.5	70	0.5	4	2	
	11	●	MHS0250L035B	28.0	35.5	38.3	90.5	90	0.5	4	2	
	23	●	MHS0250L065B	58.0	65.5	68.3	110.5	110	0.5	4	2	
	30	●	MHS0250L090B	75.5	90.5	93.3	140.5	140	0.5	4	2	

DC	Bohrtiefe (mm)	VP15TF	Bestellnummer	Abmessungen (mm)								Typ
				LU	LCF	LH	OAL	LF	PL	DCNMMS		
2.60	2	●	MHS0260L013B	5.7	13.5	16.1	70.5	70	0.5	4	1	
	5	★	MHS0260L020B	13.5	20.5	23.1	70.5	70	0.5	4	2	
	10	●	MHS0260L035B	26.5	35.5	38.1	90.5	90	0.5	4	2	
	22	●	MHS0260L065B	57.7	65.5	68.1	110.5	110	0.5	4	2	
	30	●	MHS0260L090B	78.5	90.5	93.1	140.5	140	0.5	4	2	
2.70	2	●	MHS0270L013B	5.9	13.5	15.9	70.5	70	0.5	4	1	
	4	★	MHS0270L020B	11.4	20.6	23.0	70.6	70	0.6	4	2	
	10	●	MHS0270L035B	27.6	35.6	38.0	90.6	90	0.6	4	2	
	21	●	MHS0270L065B	57.3	65.6	68.0	110.6	110	0.6	4	2	
	30	●	MHS0270L090B	81.6	90.6	93.0	140.6	140	0.6	4	2	
2.80	2	●	MHS0280L014B	6.1	14.5	16.7	70.5	70	0.5	4	1	
	4	★	MHS0280L020B	11.8	20.6	22.8	70.6	70	0.6	4	2	
	9	●	MHS0280L035B	25.8	35.6	37.8	90.6	90	0.6	4	2	
	20	●	MHS0280L065B	56.6	65.6	67.8	110.6	110	0.6	4	2	
	29	●	MHS0280L090B	81.8	90.6	92.8	140.6	140	0.6	4	2	
2.90	2	●	MHS0290L014B	6.3	14.5	16.6	70.5	70	0.5	4	1	
	4	★	MHS0290L020B	12.2	20.6	22.7	70.6	70	0.6	4	2	
	9	●	MHS0290L035B	26.7	35.6	37.7	90.6	90	0.6	4	2	
	19	●	MHS0290L065B	55.7	65.6	67.7	110.6	110	0.6	4	2	
	28	●	MHS0290L090B	81.8	90.6	92.7	140.6	140	0.6	4	2	
2.95	2	★	MHS0295L014B	6.4	14.5	16.5	70.5	70	0.5	4	1	
	4	★	MHS0295L020B	12.4	20.6	22.6	70.6	70	0.6	4	2	
	9	★	MHS0295L035B	27.2	35.6	37.6	90.6	90	0.6	4	2	
	19	●	MHS0295L065B	56.7	65.6	67.6	110.6	110	0.6	4	2	
	28	★	MHS0295L090B	83.2	90.6	92.6	140.6	140	0.6	4	2	
3.0	4	●	MHS0300L020B	12.5	19.5	20.5	70.5	70	0.5	4	3	
	10	●	MHS0300L040B	30.5	39.5	40.5	90.5	90	0.5	4	4	
	17	●	MHS0300L060B	51.5	59.5	60.5	110.5	110	0.5	4	4	
	27	●	MHS0300L090B	81.5	89.5	90.5	140.5	140	0.5	4	4	
3.1	4	□	MHS0310L020B	12.9	20.0	20.5	70.5	70	0.5	4	3	
	10	□	MHS0310L040B	31.6	40.1	40.6	90.6	90	0.6	4	4	
	17	□	MHS0310L060B	53.3	60.1	60.6	110.6	110	0.6	4	4	
	26	□	MHS0310L090B	81.2	90.1	90.6	140.6	140	0.6	4	4	
3.2	4	□	MHS0320L020B	13.4	20.1	20.6	70.6	70	0.6	4	3	
	10	□	MHS0320L040B	32.6	40.1	40.6	90.6	90	0.6	4	4	
	16	□	MHS0320L060B	51.8	60.1	60.6	110.6	110	0.6	4	4	
	25	□	MHS0320L090B	80.6	90.1	90.6	140.6	140	0.6	4	4	
3.3	3	□	MHS0330L020B	10.5	20.1	20.6	70.6	70	0.6	4	3	
	9	□	MHS0330L040B	30.3	40.1	40.6	90.6	90	0.6	4	4	
	16	□	MHS0330L060B	53.4	60.1	60.6	110.6	110	0.6	4	4	
	25	□	MHS0330L090B	83.1	90.1	90.6	140.6	140	0.6	4	4	
3.4	3	□	MHS0340L020B	10.8	20.1	20.6	70.6	70	0.6	4	3	
	9	□	MHS0340L040B	31.2	40.1	40.6	90.6	90	0.6	4	4	
	15	□	MHS0340L060B	51.6	60.1	60.6	110.6	110	0.6	4	4	
	24	□	MHS0340L090B	82.2	90.1	90.6	140.6	140	0.6	4	4	
3.5	3	●	MHS0350L020B	11.1	20.1	20.6	70.6	70	0.6	4	3	
	9	●	MHS0350L040B	32.1	40.1	40.6	90.6	90	0.6	4	4	
	14	●	MHS0350L060B	49.6	60.1	60.6	110.6	110	0.6	4	4	
	23	●	MHS0350L090B	81.1	90.1	90.6	140.6	140	0.6	4	4	

# BOHREN (VOLLHARTMETALL)

## MHS

DC (mm)	Bohr- tiefe (L/D)	VP15TF	Bestellnummer	Abmessungen (mm)								Typ
				LU	LCF	LH	OAL	LF	PL	DCONMS		
3.6	3	<input type="checkbox"/>	MHS0360L020B	11.4	20.6	20.6	70.6	70	0.6	4	3	
	9	<input type="checkbox"/>	MHS0360L040B	33.1	40.7	40.7	90.7	90	0.7	4	4	
	14	<input type="checkbox"/>	MHS0360L060B	51.1	60.7	60.7	110.7	110	0.7	4	4	
	22	<input type="checkbox"/>	MHS0360L090B	79.9	90.7	90.7	140.7	140	0.7	4	4	
	30	<input type="checkbox"/>	MHS0360L120B	108.7	120.7	120.7	170.7	170	0.7	4	4	
3.7	3	<input type="checkbox"/>	MHS0370L020B	11.7	20.6	20.6	70.6	70	0.6	4	3	
	8	<input type="checkbox"/>	MHS0370L040B	30.3	40.7	40.7	90.7	90	0.7	4	4	
	14	<input type="checkbox"/>	MHS0370L060B	52.5	60.7	60.7	110.7	110	0.7	4	4	
	22	<input type="checkbox"/>	MHS0370L090B	82.1	90.7	90.7	140.7	140	0.7	4	4	
30	<input type="checkbox"/>	MHS0370L120B	111.7	120.7	120.7	170.7	170	0.7	4	4		
3.8	3	<input checked="" type="checkbox"/>	MHS0380L020B	12.1	20.7	20.7	70.7	70	0.7	4	3	
	8	<input checked="" type="checkbox"/>	MHS0380L040B	31.1	40.7	40.7	90.7	90	0.7	4	4	
	13	<input checked="" type="checkbox"/>	MHS0380L060B	50.1	60.7	60.7	110.7	110	0.7	4	4	
	21	<input checked="" type="checkbox"/>	MHS0380L090B	80.5	90.7	90.7	140.7	140	0.7	4	4	
	29	<input checked="" type="checkbox"/>	MHS0380L120B	110.9	120.7	120.7	170.7	170	0.7	4	4	
3.9	3	<input checked="" type="checkbox"/>	MHS0390L020B	12.4	20.7	20.7	70.7	70	0.7	4	3	
	8	<input checked="" type="checkbox"/>	MHS0390L040B	31.9	40.7	40.7	90.7	90	0.7	4	4	
	13	<input checked="" type="checkbox"/>	MHS0390L060B	51.4	60.7	60.7	110.7	110	0.7	4	4	
	21	<input type="checkbox"/>	MHS0390L090B	82.6	90.7	90.7	140.7	140	0.7	4	4	
	28	<input type="checkbox"/>	MHS0390L120B	109.9	120.7	120.7	170.7	170	0.7	4	4	
4.0	2	<input checked="" type="checkbox"/>	MHS0400L020B	8.7	20.7	20.7	70.7	70	0.7	4	3	
	7	<input checked="" type="checkbox"/>	MHS0400L040B	28.7	40.7	40.7	90.7	90	0.7	4	4	
	12	<input checked="" type="checkbox"/>	MHS0400L060B	48.7	60.7	60.7	110.7	110	0.7	4	4	
	20	<input checked="" type="checkbox"/>	MHS0400L090B	80.7	90.7	90.7	140.7	140	0.7	4	4	
	27	<input checked="" type="checkbox"/>	MHS0400L120B	108.7	120.7	120.7	170.7	170	0.7	4	4	
	27	<input type="checkbox"/>	MHS0400L120B	108.7	120.7	120.7	170.7	170	0.7	4	4	
4.1	2	<input type="checkbox"/>	MHS0410L020B	8.9	19.2	20.7	70.7	70	0.7	6	3	
	7	<input type="checkbox"/>	MHS0410L040B	29.4	39.2	40.7	90.7	90	0.7	6	4	
	12	<input type="checkbox"/>	MHS0410L060B	49.9	59.2	60.7	110.7	110	0.7	6	4	
	19	<input type="checkbox"/>	MHS0410L090B	78.6	89.2	90.7	140.7	140	0.7	6	4	
	26	<input type="checkbox"/>	MHS0410L120B	107.3	119.2	120.7	170.7	170	0.7	6	4	
	26	<input type="checkbox"/>	MHS0410L120B	107.3	119.2	120.7	170.7	170	0.7	6	4	
4.2	2	<input type="checkbox"/>	MHS0420L020B	9.1	19.2	20.7	70.7	70	0.7	6	3	
	7	<input type="checkbox"/>	MHS0420L040B	30.2	39.3	40.8	90.8	90	0.8	6	4	
	11	<input type="checkbox"/>	MHS0420L060B	47.0	59.3	60.8	110.8	110	0.8	6	4	
	19	<input type="checkbox"/>	MHS0420L090B	80.6	89.3	90.8	140.8	140	0.8	6	4	
	26	<input type="checkbox"/>	MHS0420L120B	110.0	119.3	120.8	170.8	170	0.8	6	4	
4.3	2	<input type="checkbox"/>	MHS0430L020B	9.3	19.2	20.7	70.7	70	0.7	6	3	
	6	<input type="checkbox"/>	MHS0430L040B	26.6	39.3	40.8	90.8	90	0.8	6	4	
	11	<input type="checkbox"/>	MHS0430L060B	48.1	59.3	60.8	110.8	110	0.8	6	4	
	18	<input type="checkbox"/>	MHS0430L090B	78.2	89.3	90.8	140.8	140	0.8	6	4	
	25	<input type="checkbox"/>	MHS0430L120B	108.3	119.3	120.8	170.8	170	0.8	6	4	
4.4	2	<input checked="" type="checkbox"/>	MHS0440L020B	9.6	19.3	20.8	70.8	70	0.8	6	3	
	6	<input type="checkbox"/>	MHS0440L040B	27.2	39.3	40.8	90.8	90	0.8	6	4	
	11	<input type="checkbox"/>	MHS0440L060B	49.2	59.3	60.8	110.8	110	0.8	6	4	
	18	<input type="checkbox"/>	MHS0440L090B	80.0	89.3	90.8	140.8	140	0.8	6	4	
	24	<input type="checkbox"/>	MHS0440L120B	106.4	119.3	120.8	170.8	170	0.8	6	4	
4.5	2	<input checked="" type="checkbox"/>	MHS0450L020B	9.8	19.3	20.8	70.8	70	0.8	6	3	
	6	<input checked="" type="checkbox"/>	MHS0450L040B	27.8	39.3	40.8	90.8	90	0.8	6	4	
	10	<input checked="" type="checkbox"/>	MHS0450L060B	45.8	59.3	60.8	110.8	110	0.8	6	4	
	17	<input checked="" type="checkbox"/>	MHS0450L090B	77.3	89.3	90.8	140.8	140	0.8	6	4	
	24	<input checked="" type="checkbox"/>	MHS0450L120B	108.8	119.3	120.8	170.8	170	0.8	6	4	

DC (mm)	Bohr- tiefe (L/D)	VP15TF	Bestellnummer	Abmessungen (mm)								Typ
				LU	LCF	LH	OAL	LF	PL	DCONMS		
4.6	2	<input type="checkbox"/>	MHS0460L020B	10.0	19.8	20.8	70.8	70	0.8	6	3	
	6	<input type="checkbox"/>	MHS0460L040B	28.4	39.8	40.8	90.8	90	0.8	6	4	
	10	<input type="checkbox"/>	MHS0460L060B	46.8	59.8	60.8	110.8	110	0.8	6	4	
	17	<input type="checkbox"/>	MHS0460L090B	79.0	89.8	90.8	140.8	140	0.8	6	4	
	23	<input type="checkbox"/>	MHS0460L120B	106.6	119.8	120.8	170.8	170	0.8	6	4	
	30	<input type="checkbox"/>	MHS0460L150B	138.8	149.8	150.8	200.8	200	0.8	6	4	
4.7	2	<input type="checkbox"/>	MHS0470L020B	10.2	19.8	20.8	70.8	70	0.8	6	3	
	6	<input type="checkbox"/>	MHS0470L040B	29.1	39.9	40.9	90.9	90	0.9	6	4	
	10	<input type="checkbox"/>	MHS0470L060B	47.9	59.9	60.9	110.9	110	0.9	6	4	
	16	<input type="checkbox"/>	MHS0470L090B	76.1	89.9	90.9	140.9	140	0.9	6	4	
	23	<input type="checkbox"/>	MHS0470L120B	109.0	119.9	120.9	170.9	170	0.9	6	4	
	29	<input type="checkbox"/>	MHS0470L150B	137.2	149.9	150.9	200.9	200	0.9	6	4	
4.8	1	<input checked="" type="checkbox"/>	MHS0480L020B	5.6	19.8	20.8	70.8	70	0.8	6	3	
	6	<input checked="" type="checkbox"/>	MHS0480L040B	29.7	39.9	40.9	90.9	90	0.9	6	4	
	10	<input checked="" type="checkbox"/>	MHS0480L060B	48.9	59.9	60.9	110.9	110	0.9	6	4	
	16	<input checked="" type="checkbox"/>	MHS0480L090B	77.7	89.9	90.9	140.9	140	0.9	6	4	
	22	<input checked="" type="checkbox"/>	MHS0480L120B	106.5	119.9	120.9	170.9	170	0.9	6	4	
	29	<input checked="" type="checkbox"/>	MHS0480L150B	140.1	149.9	150.9	200.9	200	0.9	6	4	
4.9	1	<input type="checkbox"/>	MHS0490L020B	5.7	19.8	20.8	70.8	70	0.8	6	3	
	5	<input type="checkbox"/>	MHS0490L040B	25.4	39.9	40.9	90.9	90	0.9	6	4	
	10	<input type="checkbox"/>	MHS0490L060B	49.9	59.9	60.9	110.9	110	0.9	6	4	
	16	<input type="checkbox"/>	MHS0490L090B	79.3	89.9	90.9	140.9	140	0.9	6	4	
	22	<input type="checkbox"/>	MHS0490L120B	108.7	119.9	120.9	170.9	170	0.9	6	4	
	28	<input type="checkbox"/>	MHS0490L150B	138.1	149.9	150.9	200.9	200	0.9	6	4	
5.0	1	<input checked="" type="checkbox"/>	MHS0500L020B	5.9	19.9	20.9	70.9	70	0.9	6	3	
	5	<input checked="" type="checkbox"/>	MHS0500L040B	25.9	39.9	40.9	90.9	90	0.9	6	4	
	9	<input checked="" type="checkbox"/>	MHS0500L060B	45.9	59.9	60.9	110.9	110	0.9	6	4	
	15	<input checked="" type="checkbox"/>	MHS0500L090B	75.9	89.9	90.9	140.9	140	0.9	6	4	
	21	<input checked="" type="checkbox"/>	MHS0500L120B	105.9	119.9	120.9	170.9	170	0.9	6	4	
	27	<input checked="" type="checkbox"/>	MHS0500L150B	135.9	149.9	150.9	200.9	200	0.9	6	4	
5.1	3	<input type="checkbox"/>	MHS0510L030B	16.2	30.4	30.9	80.9	80	0.9	6	3	
	9	<input type="checkbox"/>	MHS0510L060B	46.8	60.4	60.9	110.9	110	0.9	6	4	
	15	<input type="checkbox"/>	MHS0510L090B	77.4	90.4	90.9	140.9	140	0.9	6	4	
	21	<input type="checkbox"/>	MHS0510L120B	108.0	120.4	120.9	170.9	170	0.9	6	4	
	27	<input type="checkbox"/>	MHS0510L150B	138.6	150.4	150.9	200.9	200	0.9	6	4	
	27	<input type="checkbox"/>	MHS0510L150B	138.6	150.4	150.9	200.9	200	0.9	6	4	
5.2	3	<input type="checkbox"/>	MHS0520L030B	16.5	30.4	30.9	80.9	80	0.9	6	3	
	9	<input type="checkbox"/>	MHS0520L060B	47.7	60.4	60.9	110.9	110	0.9	6	4	
	15	<input type="checkbox"/>	MHS0520L090B	78.9	90.4	90.9	140.9	140	0.9	6	4	
	20	<input type="checkbox"/>	MHS0520L120B	104.9	120.4	120.9	170.9	170	0.9	6	4	
	26	<input type="checkbox"/>	MHS0520L150B	136.1	150.4	150.9	200.9	200	0.9	6	4	
	26	<input type="checkbox"/>	MHS0520L150B	136.1	150.4	150.9	200.9	200	0.9	6	4	
5.3	3	<input type="checkbox"/>	MHS0530L030B	16.8	30.4	30.9	80.9	80	0.9	6	3	
	9	<input type="checkbox"/>	MHS0530L060B	48.7	60.5	61.0	111.0	110	1.0	6	4	
	14	<input checked="" type="checkbox"/>	MHS0530L090B	75.2	90.5	91.0	141.0	140	1.0	6	4	
	20	<input type="checkbox"/>	MHS0530L120B	107.0	120.5	121.0	171.0	170	1.0	6	4	
	26	<input type="checkbox"/>	MHS0530L150B	138.8	150.5	151.0	201.0	200	1.0	6	4	
	26	<input type="checkbox"/>	MHS0530L150B	138.8	150.5	151.0	201.0	200	1.0	6	4	
5.4	3	<input type="checkbox"/>	MHS0540L030B	17.1	30.4	30.9	80.9	80	0.9	6	3	
	9	<input type="checkbox"/>	MHS0540L060B	49.6	60.5	61.0	111.0	110	1.0	6	4	
	14	<input type="checkbox"/>	MHS0540L090B	76.6	90.5	91.0	141.0	140	1.0	6	4	
	20	<input type="checkbox"/>	MHS0540L120B	109.0	120.5	121.0	171.0	170	1.0	6	4	
	25	<input type="checkbox"/>	MHS0540L150B	136.0	150.5	151.0	201.0	200	1.0	6	4	
	25	<input type="checkbox"/>	MHS0540L150B	136.0	150.5	151.0	201.0	200	1.0	6	4	

Hinweis 1) Bei Bedarf von abweichenden Geometrien setzen Sie sich mit uns in Verbindung.  
(Andere Durchmesser und Längen können bestellt werden).



DC	Bohr- tiefe (mm)	VP15TF (L/D)	Bestellnummer	Abmessungen (mm)							Typ
				LU	LCF	LH	OAL	LF	PL	DCNMS	
5.5	3	●	MHS0550L030B	17.4	30.4	30.9	80.9	80	0.9	6	3
	8	●	MHS0550L060B	45.0	60.5	61.0	111.0	110	1.0	6	4
	14	●	MHS0550L090B	78.0	90.5	91.0	141.0	140	1.0	6	4
	19	●	MHS0550L120B	105.5	120.5	121.0	171.0	170	1.0	6	4
	25	●	MHS0550L150B	138.5	150.5	151.0	201.0	200	1.0	6	4
5.6	3	□	MHS0560L030B	17.8	31.0	31.0	81.0	80	1.0	6	3
	8	□	MHS0560L060B	45.8	61.0	61.0	111.0	110	1.0	6	4
	14	□	MHS0560L090B	79.4	91.0	91.0	141.0	140	1.0	6	4
	19	□	MHS0560L120B	107.4	121.0	121.0	171.0	170	1.0	6	4
	24	□	MHS0560L150B	135.4	151.0	151.0	201.0	200	1.0	6	4
5.7	3	□	MHS0570L030B	18.1	31.0	31.0	81.0	80	1.0	6	3
	8	□	MHS0570L060B	46.6	61.0	61.0	111.0	110	1.0	6	4
	13	□	MHS0570L090B	75.1	91.0	91.0	141.0	140	1.0	6	4
	19	□	MHS0570L120B	109.3	121.0	121.0	171.0	170	1.0	6	4
	24	□	MHS0570L150B	137.8	151.0	151.0	201.0	200	1.0	6	4
5.8	3	★	MHS0580L030B	18.4	31.0	31.0	81.0	80	1.0	6	3
	8	★	MHS0580L060B	47.5	61.1	61.1	111.1	110	1.1	6	4
	13	★	MHS0580L090B	76.5	91.1	91.1	141.1	140	1.1	6	4
	18	★	MHS0580L120B	105.5	121.1	121.1	171.1	170	1.1	6	4
	23	★	MHS0580L150B	134.5	151.1	151.1	201.1	200	1.1	6	4
5.9	3	□	MHS0590L030B	18.7	31.0	31.0	81.0	80	1.0	6	3
	8	□	MHS0590L060B	48.3	61.1	61.1	111.1	110	1.1	6	4
	13	□	MHS0590L090B	77.8	91.1	91.1	141.1	140	1.1	6	4
	18	□	MHS0590L120B	107.3	121.1	121.1	171.1	170	1.1	6	4
	23	□	MHS0590L150B	136.8	151.1	151.1	201.1	200	1.1	6	4
6.0	2	●	MHS0600L030B	13.0	31.0	31.0	81.0	80	1.0	6	3
	7	●	MHS0600L060B	43.1	61.1	61.1	111.1	110	1.1	6	4
	12	●	MHS0600L090B	73.1	91.1	91.1	141.1	140	1.1	6	4
	17	●	MHS0600L120B	103.1	121.1	121.1	171.1	170	1.1	6	4
	22	●	MHS0600L150B	133.1	151.1	151.1	201.1	200	1.1	6	4
6.1	2	□	MHS0610L030B	13.3	29.6	31.1	81.1	80	1.1	8	3
	7	□	MHS0610L060B	43.8	59.6	61.1	111.1	110	1.1	8	4
	12	□	MHS0610L090B	74.3	89.6	91.1	141.1	140	1.1	8	4
	17	□	MHS0610L120B	104.8	119.6	121.1	171.1	170	1.1	8	4
	22	□	MHS0610L150B	135.3	149.6	151.1	201.1	200	1.1	8	4
6.2	2	□	MHS0620L030B	13.5	29.6	31.1	81.1	80	1.1	8	3
	7	□	MHS0620L060B	44.5	59.6	61.1	111.1	110	1.1	8	4
	12	□	MHS0620L090B	75.5	89.6	91.1	141.1	140	1.1	8	4
	17	□	MHS0620L120B	106.5	119.6	121.1	171.1	170	1.1	8	4
	21	□	MHS0620L150B	131.3	149.6	151.1	201.1	200	1.1	8	4
6.3	2	□	MHS0630L030B	13.7	29.6	31.1	81.1	80	1.1	8	3
	7	□	MHS0630L060B	45.2	59.6	61.1	111.1	110	1.1	8	4
	12	□	MHS0630L090B	76.7	89.6	91.1	141.1	140	1.1	8	4
	16	□	MHS0630L120B	101.9	119.6	121.1	171.1	170	1.1	8	4
	21	□	MHS0630L150B	133.4	149.6	151.1	201.1	200	1.1	8	4
6.4	2	□	MHS0640L030B	13.9	29.6	31.1	81.1	80	1.1	8	3
	7	□	MHS0640L060B	46.0	59.7	61.2	111.2	110	1.2	8	4
	11	□	MHS0640L090B	71.6	89.7	91.2	141.2	140	1.2	8	4
	16	□	MHS0640L120B	103.6	119.7	121.2	171.2	170	1.2	8	4
	21	□	MHS0640L150B	135.6	149.7	151.2	201.2	200	1.2	8	4

DC	Bohr- tiefe (mm)	VP15TF (L/D)	Bestellnummer	Abmessungen (mm)							Typ
				LU	LCF	LH	OAL	LF	PL	DCNMS	
6.5	2	●	MHS0650L030B	14.1	29.6	31.1	81.1	80	1.1	8	3
	6	●	MHS0650L060B	40.2	59.7	61.2	111.2	110	1.2	8	4
	11	●	MHS0650L090B	72.7	89.7	91.2	141.2	140	1.2	8	4
	16	●	MHS0650L120B	105.2	119.7	121.2	171.2	170	1.2	8	4
	20	●	MHS0650L150B	131.2	149.7	151.2	201.2	200	1.2	8	4
6.6	2	□	MHS0660L030B	14.3	30.1	31.1	81.1	80	1.1	8	3
	6	□	MHS0660L060B	40.8	60.2	61.2	111.2	110	1.2	8	4
	11	□	MHS0660L090B	73.8	90.2	91.2	141.2	140	1.2	8	4
	16	□	MHS0660L120B	106.8	120.2	121.2	171.2	170	1.2	8	4
	20	□	MHS0660L150B	133.2	150.2	151.2	201.2	200	1.2	8	4
6.7	2	□	MHS0670L030B	14.6	30.2	31.2	81.2	80	1.2	8	3
	6	□	MHS0670L060B	41.4	60.2	61.2	111.2	110	1.2	8	4
	11	□	MHS0670L090B	74.9	90.2	91.2	141.2	140	1.2	8	4
	15	□	MHS0670L120B	101.7	120.2	121.2	171.2	170	1.2	8	4
	20	□	MHS0670L150B	135.2	150.2	151.2	201.2	200	1.2	8	4
6.8	2	★	MHS0680L030B	14.8	30.2	31.2	81.2	80	1.2	8	3
	6	★	MHS0680L060B	42.0	60.2	61.2	111.2	110	1.2	8	4
	11	★	MHS0680L090B	76.0	90.2	91.2	141.2	140	1.2	8	4
	15	★	MHS0680L120B	103.2	120.2	121.2	171.2	170	1.2	8	4
	19	★	MHS0680L150B	130.4	150.2	151.2	201.2	200	1.2	8	4
6.9	2	□	MHS0690L030B	15.0	30.2	31.2	81.2	80	1.2	8	3
	6	□	MHS0690L060B	42.7	60.3	61.3	111.3	110	1.3	8	4
	10	□	MHS0690L090B	70.3	90.3	91.3	141.3	140	1.3	8	4
	15	□	MHS0690L120B	104.8	120.3	121.3	171.3	170	1.3	8	4
	19	□	MHS0690L150B	132.4	150.3	151.3	201.3	200	1.3	8	4
7.0	2	●	MHS0700L030B	15.2	30.2	31.2	81.2	80	1.2	8	3
	6	●	MHS0700L060B	43.3	60.3	61.3	111.3	110	1.3	8	4
	10	●	MHS0700L090B	71.3	90.3	91.3	141.3	140	1.3	8	4
	14	●	MHS0700L120B	99.3	120.3	121.3	171.3	170	1.3	8	4
	19	●	MHS0700L150B	134.3	150.3	151.3	201.3	200	1.3	8	4
7.1	2	□	MHS0710L030B	15.4	30.7	31.2	81.2	80	1.2	8	3
	6	□	MHS0710L060B	43.9	60.8	61.3	111.3	110	1.3	8	4
	10	□	MHS0710L090B	72.3	90.8	91.3	141.3	140	1.3	8	4
	14	□	MHS0710L120B	100.7	120.8	121.3	171.3	170	1.3	8	4
	19	□	MHS0710L150B	136.2	150.8	151.3	201.3	200	1.3	8	4
7.2	2	□	MHS0720L030B	15.6	30.7	31.2	81.2	80	1.2	8	3
	6	□	MHS0720L060B	44.5	60.8	61.3	111.3	110	1.3	8	4
	10	□	MHS0720L090B	73.3	90.8	91.3	141.3	140	1.3	8	4
	14	□	MHS0720L120B	102.1	120.8	121.3	171.3	170	1.3	8	4
	18	□	MHS0720L150B	130.9	150.8	151.3	201.3	200	1.3	8	4
25	□	MHS0720L200B	181.3	200.8	201.3	251.3	250	1.3	8	4	

M

BOHREN

# MHS

M  
BOHREN

DC	Bohr- tiefe	VP15TF	Bestellnummer	Abmessungen (mm)							Typ	
				LU	LCF	LH	OAL	LF	PL	DCONMS		
7.3	2	□	MHS0730L030B	15.9	30.8	31.3	81.3	80	1.3	8	3	
	6	□	MHS0730L060B	45.1	60.8	61.3	111.3	110	1.3	8	4	
	10	□	MHS0730L090B	74.3	90.8	91.3	141.3	140	1.3	8	4	
	14	□	MHS0730L120B	103.5	120.8	121.3	171.3	170	1.3	8	4	
	18	□	MHS0730L150B	132.7	150.8	151.3	201.3	200	1.3	8	4	
	25	□	MHS0730L200B	183.8	200.8	201.3	251.3	250	1.3	8	4	
7.4	1	□	MHS0740L030B	8.7	30.8	31.3	81.3	80	1.3	8	3	
	6	□	MHS0740L060B	45.7	60.8	61.3	111.3	110	1.3	8	4	
	10	□	MHS0740L090B	75.3	90.8	91.3	141.3	140	1.3	8	4	
	14	□	MHS0740L120B	104.9	120.8	121.3	171.3	170	1.3	8	4	
	18	□	MHS0740L150B	134.5	150.8	151.3	201.3	200	1.3	8	4	
	24	□	MHS0740L200B	178.9	200.8	201.3	251.3	250	1.3	8	4	
7.5	1	●	MHS0750L030B	8.8	30.8	31.3	81.3	80	1.3	8	3	
	5	●	MHS0750L060B	38.9	60.9	61.4	111.4	110	1.4	8	4	
	9	●	MHS0750L090B	68.9	90.9	91.4	141.4	140	1.4	8	4	
	13	●	MHS0750L120B	98.9	120.9	121.4	171.4	170	1.4	8	4	
	17	●	MHS0750L150B	128.9	150.9	151.4	201.4	200	1.4	8	4	
	24	●	MHS0750L200B	181.4	200.9	201.4	251.4	250	1.4	8	4	
7.6	1	□	MHS0760L030B	8.9	31.3	31.3	81.3	80	1.3	8	3	
	5	□	MHS0760L060B	39.4	61.4	61.4	111.4	110	1.4	8	4	
	9	□	MHS0760L090B	69.8	91.4	91.4	141.4	140	1.4	8	4	
	13	□	MHS0760L120B	100.2	121.4	121.4	171.4	170	1.4	8	4	
	17	□	MHS0760L150B	130.6	151.4	151.4	201.4	200	1.4	8	4	
	24	□	MHS0760L200B	183.8	201.4	201.4	251.4	250	1.4	8	4	
7.7	1	□	MHS0770L030B	9.0	31.3	31.3	81.3	80	1.3	8	3	
	5	□	MHS0770L060B	39.9	61.4	61.4	111.4	110	1.4	8	4	
	9	□	MHS0770L090B	70.7	91.4	91.4	141.4	140	1.4	8	4	
	13	□	MHS0770L120B	101.5	121.4	121.4	171.4	170	1.4	8	4	
	17	□	MHS0770L150B	132.3	151.4	151.4	201.4	200	1.4	8	4	
	23	□	MHS0770L200B	178.5	201.4	201.4	251.4	250	1.4	8	4	
7.8	1	★	MHS0780L030B	9.1	31.3	31.3	81.3	80	1.3	8	3	
	5	★	MHS0780L060B	40.4	61.4	61.4	111.4	110	1.4	8	4	
	9	★	MHS0780L090B	71.6	91.4	91.4	141.4	140	1.4	8	4	
	13	★	MHS0780L120B	102.8	121.4	121.4	171.4	170	1.4	8	4	
	17	★	MHS0780L150B	134.0	151.4	151.4	201.4	200	1.4	8	4	
	23	★	MHS0780L200B	180.8	201.4	201.4	251.4	250	1.4	8	4	
7.9	1	□	MHS0790L030B	9.3	31.4	31.4	81.4	80	1.4	8	3	
	5	□	MHS0790L060B	40.9	61.4	61.4	111.4	110	1.4	8	4	
	9	□	MHS0790L090B	72.5	91.4	91.4	141.4	140	1.4	8	4	
	13	□	MHS0790L120B	104.1	121.4	121.4	171.4	170	1.4	8	4	
	16	□	MHS0790L150B	127.8	151.4	151.4	201.4	200	1.4	8	4	
	23	□	MHS0790L200B	183.1	201.4	201.4	251.4	250	1.4	8	4	
7.3	1	●	MHS0800L030B	9.4	31.4	31.4	81.4	80	1.4	8	3	
	5	●	MHS0800L060B	41.5	61.5	61.5	111.5	110	1.5	8	4	
	9	●	MHS0800L090B	73.5	91.5	91.5	141.5	140	1.5	8	4	
	12	●	MHS0800L120B	97.5	121.5	121.5	171.5	170	1.5	8	4	
	16	●	MHS0800L150B	129.5	151.5	151.5	201.5	200	1.5	8	4	
	22	●	MHS0800L200B	177.5	201.5	201.5	251.5	250	1.5	8	4	
8.0	29	●	MHS0800L250B	233.5	251.5	251.5	301.5	300	1.5	8	4	
	8.1	2	□	MHS0810L040B	17.6	39.9	41.4	101.4	100	1.4	10	3
		8	□	MHS0810L090B	66.3	90.0	91.5	151.5	150	1.5	10	4
		12	□	MHS0810L120B	98.7	120.0	121.5	181.5	180	1.5	10	4
		16	□	MHS0810L150B	131.1	150.0	151.5	211.5	210	1.5	10	4
		22	□	MHS0810L200B	179.7	200.0	201.5	261.5	260	1.5	10	4
28		□	MHS0810L250B	228.3	250.0	251.5	311.5	310	1.5	10	4	
8.2	2	□	MHS0820L040B	17.8	39.9	41.4	101.4	100	1.4	10	3	
	8	□	MHS0820L090B	67.1	90.0	91.5	151.5	150	1.5	10	4	
	12	□	MHS0820L120B	99.9	120.0	121.5	181.5	180	1.5	10	4	
	16	□	MHS0820L150B	132.7	150.0	151.5	211.5	210	1.5	10	4	
	22	□	MHS0820L200B	181.9	200.0	201.5	261.5	260	1.5	10	4	
	28	□	MHS0820L250B	231.1	250.0	251.5	311.5	310	1.5	10	4	
8.3	2	□	MHS0830L040B	18.0	39.9	41.4	101.4	100	1.4	10	3	
	8	□	MHS0830L090B	67.9	90.0	91.5	151.5	150	1.5	10	4	
	12	□	MHS0830L120B	101.1	120.0	121.5	181.5	180	1.5	10	4	
	15	□	MHS0830L150B	126.0	150.0	151.5	211.5	210	1.5	10	4	
	21	□	MHS0830L200B	175.8	200.0	201.5	261.5	260	1.5	10	4	
	27	□	MHS0830L250B	225.6	250.0	251.5	311.5	310	1.5	10	4	
8.4	2	□	MHS0840L040B	18.2	39.9	41.4	101.4	100	1.4	10	3	
	8	□	MHS0840L090B	68.7	90.0	91.5	151.5	150	1.5	10	4	
	12	□	MHS0840L120B	102.3	120.0	121.5	181.5	180	1.5	10	4	
	15	□	MHS0840L150B	127.5	150.0	151.5	211.5	210	1.5	10	4	
	21	□	MHS0840L200B	177.9	200.0	201.5	261.5	260	1.5	10	4	
	27	□	MHS0840L250B	228.3	250.0	251.5	311.5	310	1.5	10	4	
8.5	2	●	MHS0850L040B	18.5	40.0	41.5	101.5	100	1.5	10	3	
	8	●	MHS0850L090B	69.5	90.0	91.5	151.5	150	1.5	10	4	
	11	●	MHS0850L120B	95.0	120.0	121.5	181.5	180	1.5	10	4	
	15	●	MHS0850L150B	129.0	150.0	151.5	211.5	210	1.5	10	4	
	21	●	MHS0850L200B	180.0	200.0	201.5	261.5	260	1.5	10	4	
	27	●	MHS0850L250B	231.0	250.0	251.5	311.5	310	1.5	10	4	
8.6	2	□	MHS0860L040B	18.7	40.5	41.5	101.5	100	1.5	10	3	
	8	□	MHS0860L090B	70.4	90.6	91.6	151.6	150	1.6	10	4	
	11	□	MHS0860L120B	96.2	120.6	121.6	181.6	180	1.6	10	4	
	15	□	MHS0860L150B	130.6	150.6	151.6	211.6	210	1.6	10	4	
	21	□	MHS0860L200B	182.2	200.6	201.6	261.6	260	1.6	10	4	
	26	□	MHS0860L250B	225.2	250.6	251.6	311.6	310	1.6	10	4	
8.7	2	□	MHS0870L040B	18.9	40.5	41.5	101.5	100	1.5	10	3	
	8	□	MHS0870L090B	71.2	90.6	91.6	151.6	150	1.6	10	4	
	11	□	MHS0870L120B	97.3	120.6	121.6	181.6	180	1.6	10	4	
	15	□	MHS0870L150B	132.1	150.6	151.6	211.6	210	1.6	10	4	
	20	□	MHS0870L200B	175.6	200.6	201.6	261.6	260	1.6	10	4	
	26	□	MHS0870L250B	227.8	250.6	251.6	311.6	310	1.6	10	4	

Hinweis 1) Bei Bedarf von abweichenden Geometrien setzen Sie sich mit uns in Verbindung.  
(Andere Durchmesser und Längen können bestellt werden).

● : Lagerstandard. ★ : Lagerstandard in Japan.

□ : Herstellung nur auf Anfrage

DC	Bohr- tiefe (mm)	VP15TF (L/D)	Bestellnummer	Abmessungen (mm)							Typ
				LU	LCF	LH	OAL	LF	PL	DCONMS	
8.8	2	★	MHS0880L040B	19.1	40.5	41.5	101.5	100	1.5	10	3
	8	★	MHS0880L090B	72.0	90.6	91.6	151.6	150	1.6	10	4
	11	★	MHS0880L120B	98.4	120.6	121.6	181.6	180	1.6	10	4
	14	★	MHS0880L150B	124.8	150.6	151.6	211.6	210	1.6	10	4
	20	★	MHS0880L200B	177.6	200.6	201.6	261.6	260	1.6	10	4
	26	★	MHS0880L250B	230.4	250.6	251.6	311.6	310	1.6	10	4
8.9	2	□	MHS0890L040B	19.3	40.5	41.5	101.5	100	1.5	10	3
	7	□	MHS0890L090B	63.9	90.6	91.6	151.6	150	1.6	10	4
	11	□	MHS0890L120B	99.5	120.6	121.6	181.6	180	1.6	10	4
	14	□	MHS0890L150B	126.2	150.6	151.6	211.6	210	1.6	10	4
	20	□	MHS0890L200B	179.6	200.6	201.6	261.6	260	1.6	10	4
	25	□	MHS0890L250B	224.1	250.6	251.6	311.6	310	1.6	10	4
9.0	2	●	MHS0900L040B	19.5	40.5	41.5	101.5	100	1.5	10	3
	7	●	MHS0900L090B	64.6	90.6	91.6	151.6	150	1.6	10	4
	11	●	MHS0900L120B	100.6	120.6	121.6	181.6	180	1.6	10	4
	14	●	MHS0900L150B	127.6	150.6	151.6	211.6	210	1.6	10	4
	20	●	MHS0900L200B	181.6	200.6	201.6	261.6	260	1.6	10	4
	25	●	MHS0900L250B	226.6	250.6	251.6	311.6	310	1.6	10	4
9.1	2	□	MHS0910L040B	19.8	41.1	41.6	101.6	100	1.6	10	3
	7	□	MHS0910L090B	65.4	91.2	91.7	151.7	150	1.7	10	4
	11	□	MHS0910L120B	101.8	121.2	121.7	181.7	180	1.7	10	4
	14	□	MHS0910L150B	129.1	151.2	151.7	211.7	210	1.7	10	4
	19	□	MHS0910L200B	174.6	201.2	201.7	261.7	260	1.7	10	4
	25	□	MHS0910L250B	229.2	251.2	251.7	311.7	310	1.7	10	4
30	□	MHS0910L300B	274.7	301.2	301.7	361.7	360	1.7	10	4	
9.2	2	□	MHS0920L040B	20.0	41.1	41.6	101.6	100	1.6	10	3
	7	□	MHS0920L090B	66.1	91.2	91.7	151.7	150	1.7	10	4
	10	□	MHS0920L120B	93.7	121.2	121.7	181.7	180	1.7	10	4
	14	□	MHS0920L150B	130.5	151.2	151.7	211.7	210	1.7	10	4
	19	□	MHS0920L200B	176.5	201.2	201.7	261.7	260	1.7	10	4
	25	□	MHS0920L250B	231.7	251.2	251.7	311.7	310	1.7	10	4
30	□	MHS0920L300B	277.7	301.2	301.7	361.7	360	1.7	10	4	
9.3	2	□	MHS0930L040B	20.2	41.1	41.6	101.6	100	1.6	10	3
	7	□	MHS0930L090B	66.8	91.2	91.7	151.7	150	1.7	10	4
	10	□	MHS0930L120B	94.7	121.2	121.7	181.7	180	1.7	10	4
	14	□	MHS0930L150B	131.9	151.2	151.7	211.7	210	1.7	10	4
	19	□	MHS0930L200B	178.4	201.2	201.7	261.7	260	1.7	10	4
	24	□	MHS0930L250B	224.9	251.2	251.7	311.7	310	1.7	10	4
30	□	MHS0930L300B	280.7	301.2	301.7	361.7	360	1.7	10	4	
9.4	2	□	MHS0940L040B	20.4	41.1	41.6	101.6	100	1.6	10	3
	7	□	MHS0940L090B	67.5	91.2	91.7	151.7	150	1.7	10	4
	10	□	MHS0940L120B	95.7	121.2	121.7	181.7	180	1.7	10	4
	13	□	MHS0940L150B	123.9	151.2	151.7	211.7	210	1.7	10	4
	19	□	MHS0940L200B	180.3	201.2	201.7	261.7	260	1.7	10	4
	24	□	MHS0940L250B	227.3	251.2	251.7	311.7	310	1.7	10	4
29	□	MHS0940L300B	274.3	301.2	301.7	361.7	360	1.7	10	4	

DC	Bohr- tiefe (mm)	VP15TF (L/D)	Bestellnummer	Abmessungen (mm)							Typ
				LU	LCF	LH	OAL	LF	PL	DCONMS	
9.5	2	★	MHS0950L040B	20.6	41.1	41.6	101.6	100	1.6	10	3
	7	★	MHS0950L090B	68.2	91.2	91.7	151.7	150	1.7	10	4
	10	★	MHS0950L120B	96.7	121.2	121.7	181.7	180	1.7	10	4
	13	★	MHS0950L150B	125.2	151.2	151.7	211.7	210	1.7	10	4
	18	★	MHS0950L200B	172.7	201.2	201.7	261.7	260	1.7	10	4
	24	★	MHS0950L250B	229.7	251.2	251.7	311.7	310	1.7	10	4
	29	★	MHS0950L300B	277.2	301.2	301.7	361.7	360	1.7	10	4
9.6	2	□	MHS0960L040B	20.9	41.7	41.7	101.7	100	1.7	10	3
	7	□	MHS0960L090B	68.9	91.7	91.7	151.7	150	1.7	10	4
	10	□	MHS0960L120B	97.7	121.7	121.7	181.7	180	1.7	10	4
	13	□	MHS0960L150B	126.5	151.7	151.7	211.7	210	1.7	10	4
	18	□	MHS0960L200B	174.5	201.7	201.7	261.7	260	1.7	10	4
	24	□	MHS0960L250B	232.1	251.7	251.7	311.7	310	1.7	10	4
	29	□	MHS0960L300B	280.1	301.7	301.7	361.7	360	1.7	10	4
9.7	2	□	MHS0970L040B	21.1	41.7	41.7	101.7	100	1.7	10	3
	7	□	MHS0970L090B	69.7	91.8	91.8	151.8	150	1.8	10	4
	10	□	MHS0970L120B	98.8	121.8	121.8	181.8	180	1.8	10	4
	13	□	MHS0970L150B	127.9	151.8	151.8	211.8	210	1.8	10	4
	18	□	MHS0970L200B	176.4	201.8	201.8	261.8	260	1.8	10	4
	23	□	MHS0970L250B	224.9	251.8	251.8	311.8	310	1.8	10	4
	28	□	MHS0970L300B	273.4	301.8	301.8	361.8	360	1.8	10	4
9.8	2	★	MHS0980L040B	21.3	41.7	41.7	101.7	100	1.7	10	3
	7	★	MHS0980L090B	70.4	91.8	91.8	151.8	150	1.8	10	4
	10	★	MHS0980L120B	99.8	121.8	121.8	181.8	180	1.8	10	4
	13	★	MHS0980L150B	129.2	151.8	151.8	211.8	210	1.8	10	4
	18	★	MHS0980L200B	178.2	201.8	201.8	261.8	260	1.8	10	4
	23	★	MHS0980L250B	227.2	251.8	251.8	311.8	310	1.8	10	4
	28	★	MHS0980L300B	276.2	301.8	301.8	361.8	360	1.8	10	4
9.9	2	□	MHS0990L040B	21.5	41.7	41.7	101.7	100	1.7	10	3
	7	□	MHS0990L090B	71.1	91.8	91.8	151.8	150	1.8	10	4
	10	□	MHS0990L120B	100.8	121.8	121.8	181.8	180	1.8	10	4
	13	□	MHS0990L150B	130.5	151.8	151.8	211.8	210	1.8	10	4
	18	□	MHS0990L200B	180.0	201.8	201.8	261.8	260	1.8	10	4
	23	□	MHS0990L250B	229.5	251.8	251.8	311.8	310	1.8	10	4
	28	□	MHS0990L300B	279.0	301.8	301.8	361.8	360	1.8	10	4
10.0	1	●	MHS1000L040B	11.7	41.7	41.7	101.7	100	1.7	10	3
	6	●	MHS1000L090B	61.8	91.8	91.8	151.8	150	1.8	10	4
	9	●	MHS1000L120B	91.8	121.8	121.8	181.8	180	1.8	10	4
	12	●	MHS1000L150B	121.8	151.8	151.8	211.8	210	1.8	10	4
	17	●	MHS1000L200B	171.8	201.8	201.8	261.8	260	1.8	10	4
	22	●	MHS1000L250B	221.8	251.8	251.8	311.8	310	1.8	10	4
	27	●	MHS1000L300B	271.8	301.8	301.8	361.8	360	1.8	10	4
10.1	1	□	MHS1010L040B	11.8	40.2	41.7	101.7	100	1.7	12	3
	6	□	MHS1010L090B	62.4	90.3	91.8	151.8	150	1.8	12	4
	9	□	MHS1010L120B	92.7	120.3	121.8	181.8	180	1.8	12	4
	12	□	MHS1010L150B	123.0	150.3	151.8	211.8	210	1.8	12	4
	17	□	MHS1010L200B	173.5	200.3	201.8	261.8	260	1.8	12	4
	22	□	MHS1010L250B	224.0	250.3	251.8	311.8	310	1.8	12	4
	27	□	MHS1010L300B	274.5	300.3	301.8	361.8	360	1.8	12	4

M

BOHREN

# BOHREN (VOLLHARTMETALL)

# MHS

HARTMETALL

M  
BOHREN

DC (mm)	Bohr- tiefe (L/D)	VP15TF	Bestellnummer	Abmessungen (mm)							Typ
				LU	LCF	LH	OAL	LF	PL	DCONMS	
10.2	1	<input type="checkbox"/>	MHS1020L040B	12.0	40.3	41.8	101.8	100	1.8	12	3
	6	<input type="checkbox"/>	MHS1020L090B	63.1	90.4	91.9	151.9	150	1.9	12	4
	9	<input type="checkbox"/>	MHS1020L120B	93.7	120.4	121.9	181.9	180	1.9	12	4
	12	<input type="checkbox"/>	MHS1020L150B	124.3	150.4	151.9	211.9	210	1.9	12	4
	17	<input type="checkbox"/>	MHS1020L200B	175.3	200.4	201.9	261.9	260	1.9	12	4
	22	<input type="checkbox"/>	MHS1020L250B	226.3	250.4	251.9	311.9	310	1.9	12	4
	27	<input type="checkbox"/>	MHS1020L300B	277.3	300.4	301.9	361.9	360	1.9	12	4
10.3	1	<input type="checkbox"/>	MHS1030L040B	12.1	40.3	41.8	101.8	100	1.8	12	3
	6	<input type="checkbox"/>	MHS1030L090B	63.7	90.4	91.9	151.9	150	1.9	12	4
	9	<input type="checkbox"/>	MHS1030L120B	94.6	120.4	121.9	181.9	180	1.9	12	4
	12	<input type="checkbox"/>	MHS1030L150B	125.5	150.4	151.9	211.9	210	1.9	12	4
	17	<input type="checkbox"/>	MHS1030L200B	177.0	200.4	201.9	261.9	260	1.9	12	4
	22	<input type="checkbox"/>	MHS1030L250B	228.5	250.4	251.9	311.9	310	1.9	12	4
	26	<input type="checkbox"/>	MHS1030L300B	269.7	300.4	301.9	361.9	360	1.9	12	4
10.4	1	<input type="checkbox"/>	MHS1040L040B	12.2	40.3	41.8	101.8	100	1.8	12	3
	6	<input type="checkbox"/>	MHS1040L090B	64.3	90.4	91.9	151.9	150	1.9	12	4
	9	<input type="checkbox"/>	MHS1040L120B	95.5	120.4	121.9	181.9	180	1.9	12	4
	12	<input type="checkbox"/>	MHS1040L150B	126.7	150.4	151.9	211.9	210	1.9	12	4
	17	<input type="checkbox"/>	MHS1040L200B	178.7	200.4	201.9	261.9	260	1.9	12	4
	21	<input type="checkbox"/>	MHS1040L250B	220.3	250.4	251.9	311.9	310	1.9	12	4
	26	<input type="checkbox"/>	MHS1040L300B	272.3	300.4	301.9	361.9	360	1.9	12	4
10.5	1	★	MHS1050L040B	12.3	40.3	41.8	101.8	100	1.8	12	3
	6	★	MHS1050L090B	64.9	90.4	91.9	151.9	150	1.9	12	4
	9	★	MHS1050L120B	96.4	120.4	121.9	181.9	180	1.9	12	4
	12	★	MHS1050L150B	127.9	150.4	151.9	211.9	210	1.9	12	4
	16	★	MHS1050L200B	169.9	200.4	201.9	261.9	260	1.9	12	4
	21	★	MHS1050L250B	222.4	250.4	251.9	311.9	310	1.9	12	4
	26	★	MHS1050L300B	274.9	300.4	301.9	361.9	360	1.9	12	4
10.6	1	<input type="checkbox"/>	MHS1060L040B	12.4	40.8	41.8	101.8	100	1.8	12	3
	6	<input type="checkbox"/>	MHS1060L090B	65.5	90.9	91.9	151.9	150	1.9	12	4
	9	<input type="checkbox"/>	MHS1060L120B	97.3	120.9	121.9	181.9	180	1.9	12	4
	12	<input type="checkbox"/>	MHS1060L150B	129.1	150.9	151.9	211.9	210	1.9	12	4
	16	<input type="checkbox"/>	MHS1060L200B	171.5	200.9	201.9	261.9	260	1.9	12	4
	21	<input type="checkbox"/>	MHS1060L250B	224.5	250.9	251.9	311.9	310	1.9	12	4
	26	<input type="checkbox"/>	MHS1060L300B	277.5	300.9	301.9	361.9	360	1.9	12	4
10.7	1	<input type="checkbox"/>	MHS1070L040B	12.5	40.8	41.8	101.8	100	1.8	12	3
	6	<input type="checkbox"/>	MHS1070L090B	66.1	90.9	91.9	151.9	150	1.9	12	4
	9	<input type="checkbox"/>	MHS1070L120B	98.2	120.9	121.9	181.9	180	1.9	12	4
	11	<input type="checkbox"/>	MHS1070L150B	119.6	150.9	151.9	211.9	210	1.9	12	4
	16	<input type="checkbox"/>	MHS1070L200B	173.1	200.9	201.9	261.9	260	1.9	12	4
	21	<input type="checkbox"/>	MHS1070L250B	226.6	250.9	251.9	311.9	310	1.9	12	4
	25	<input type="checkbox"/>	MHS1070L300B	269.4	300.9	301.9	361.9	360	1.9	12	4
10.8	1	★	MHS1080L040B	12.7	40.9	41.9	101.9	100	1.9	12	3
	6	★	MHS1080L090B	66.8	91.0	92.0	152.0	150	2.0	12	4
	9	★	MHS1080L120B	99.2	121.0	122.0	182.0	180	2.0	12	4
	11	★	MHS1080L150B	120.8	151.0	152.0	212.0	210	2.0	12	4
	16	★	MHS1080L200B	174.8	201.0	202.0	262.0	260	2.0	12	4
	21	★	MHS1080L250B	228.8	251.0	252.0	312.0	310	2.0	12	4
	25	★	MHS1080L300B	272.0	301.0	302.0	362.0	360	2.0	12	4

DC (mm)	Bohr- tiefe (L/D)	VP15TF	Bestellnummer	Abmessungen (mm)							Typ
				LU	LCF	LH	OAL	LF	PL	DCONMS	
10.9	1	<input type="checkbox"/>	MHS1090L040B	12.8	40.9	41.9	101.9	100	1.9	12	3
	6	<input type="checkbox"/>	MHS1090L090B	67.4	91.0	92.0	152.0	150	2.0	12	4
	8	<input type="checkbox"/>	MHS1090L120B	89.2	121.0	122.0	182.0	180	2.0	12	4
	11	<input type="checkbox"/>	MHS1090L150B	121.9	151.0	152.0	212.0	210	2.0	12	4
	16	<input type="checkbox"/>	MHS1090L200B	176.4	201.0	202.0	262.0	260	2.0	12	4
	20	<input type="checkbox"/>	MHS1090L250B	220.0	251.0	252.0	312.0	310	2.0	12	4
	25	<input type="checkbox"/>	MHS1090L300B	274.5	301.0	302.0	362.0	360	2.0	12	4
11.0	1	●	MHS1100L040B	12.9	40.9	41.9	101.9	100	1.9	12	3
	6	●	MHS1100L090B	68.0	91.0	92.0	152.0	150	2.0	12	4
	8	●	MHS1100L120B	90.0	121.0	122.0	182.0	180	2.0	12	4
	11	●	MHS1100L150B	123.0	151.0	152.0	212.0	210	2.0	12	4
	16	●	MHS1100L200B	178.0	201.0	202.0	262.0	260	2.0	12	4
	20	●	MHS1100L250B	222.0	251.0	252.0	312.0	310	2.0	12	4
	25	●	MHS1100L300B	277.0	301.0	302.0	362.0	360	2.0	12	4
11.1	1	<input type="checkbox"/>	MHS1110L040B	13.0	41.4	41.9	101.9	100	1.9	12	3
	6	<input type="checkbox"/>	MHS1110L090B	68.6	91.5	92.0	152.0	150	2.0	12	4
	8	<input type="checkbox"/>	MHS1110L120B	90.8	121.5	122.0	182.0	180	2.0	12	4
	11	<input type="checkbox"/>	MHS1110L150B	124.1	151.5	152.0	212.0	210	2.0	12	4
	15	<input type="checkbox"/>	MHS1110L200B	168.5	201.5	202.0	262.0	260	2.0	12	4
	20	<input type="checkbox"/>	MHS1110L250B	224.0	251.5	252.0	312.0	310	2.0	12	4
	24	<input type="checkbox"/>	MHS1110L300B	268.4	301.5	302.0	362.0	360	2.0	12	4
11.2	1	<input type="checkbox"/>	MHS1120L040B	13.1	41.4	41.9	101.9	100	1.9	12	3
	5	<input type="checkbox"/>	MHS1120L090B	58.0	91.5	92.0	152.0	150	2.0	12	4
	8	<input type="checkbox"/>	MHS1120L120B	91.6	121.5	122.0	182.0	180	2.0	12	4
	11	<input type="checkbox"/>	MHS1120L150B	125.2	151.5	152.0	212.0	210	2.0	12	4
	15	<input type="checkbox"/>	MHS1120L200B	170.0	201.5	202.0	262.0	260	2.0	12	4
	20	<input type="checkbox"/>	MHS1120L250B	226.0	251.5	252.0	312.0	310	2.0	12	4
	24	<input type="checkbox"/>	MHS1120L300B	270.8	301.5	302.0	362.0	360	2.0	12	4
11.3	1	<input type="checkbox"/>	MHS1130L040B	13.2	41.4	41.9	101.9	100	1.9	12	3
	5	<input type="checkbox"/>	MHS1130L090B	58.6	91.6	92.1	152.1	150	2.1	12	4
	8	<input type="checkbox"/>	MHS1130L120B	92.5	121.6	122.1	182.1	180	2.1	12	4
	11	<input type="checkbox"/>	MHS1130L150B	126.4	151.6	152.1	212.1	210	2.1	12	4
	15	<input type="checkbox"/>	MHS1130L200B	171.6	201.6	202.1	262.1	260	2.1	12	4
	20	<input type="checkbox"/>	MHS1130L250B	228.1	251.6	252.1	312.1	310	2.1	12	4
	24	<input type="checkbox"/>	MHS1130L300B	273.3	301.6	302.1	362.1	360	2.1	12	4
11.4	1	<input type="checkbox"/>	MHS1140L040B	13.4	41.5	42.0	102.0	100	2.0	12	3
	5	<input type="checkbox"/>	MHS1140L090B	59.1	91.6	92.1	152.1	150	2.1	12	4
	8	<input type="checkbox"/>	MHS1140L120B	93.3	121.6	122.1	182.1	180	2.1	12	4
	11	<input type="checkbox"/>	MHS1140L150B	127.5	151.6	152.1	212.1	210	2.1	12	4
	15	<input type="checkbox"/>	MHS1140L200B	173.1	201.6	202.1	262.1	260	2.1	12	4
	19	<input type="checkbox"/>	MHS1140L250B	218.7	251.6	252.1	312.1	310	2.1	12	4
	24	<input type="checkbox"/>	MHS1140L300B	275.7	301.6	302.1	362.1	360	2.1	12	4
11.5	1	★	MHS1150L040B	13.5	41.5	42.0	102.0	100	2.0	12	3
	5	★	MHS1150L090B	59.6	91.6	92.1	152.1	150	2.1	12	4
	8	★	MHS1150L120B	94.1	121.6	122.1	182.1	180	2.1	12	4
	10	★	MHS1150L150B	117.1	151.6	152.1	212.1	210	2.1	12	4
	15	★	MHS1150L200B	174.6	201.6	202.1	262.1	260	2.1	12	4
	19	★	MHS1150L250B	220.6	251.6	252.1	312.1	310	2.1	12	4
	24	★	MHS1150L300B	278.1	301.6	302.1	362.1	360	2.1	12	4

Hinweis 1) Bei Bedarf von abweichenden Geometrien setzen Sie sich mit uns in Verbindung.  
(Andere Durchmesser und Längen können bestellt werden).

● : Lagerstandard. ★ : Lagerstandard in Japan.

□ : Herstellung nur auf Anfrage

DC	Bohr- tiefe (mm)	VP15TF (L/D)	Bestellnummer	Abmessungen (mm)								Typ
				LU	LCF	LH	OAL	LF	PL	DCNMS		
11.6	1	□	MHS1160L040B	13.6	42.0	42.0	102.0	100	2.0	12	3	
	5	□	MHS1160L090B	60.1	92.1	92.1	152.1	150	2.1	12	4	
	8	□	MHS1160L120B	94.9	122.1	122.1	182.1	180	2.1	12	4	
	10	□	MHS1160L150B	118.1	152.1	152.1	212.1	210	2.1	12	4	
	15	□	MHS1160L200B	176.1	202.1	202.1	262.1	260	2.1	12	4	
	19	□	MHS1160L250B	222.5	252.1	252.1	312.1	310	2.1	12	4	
	23	□	MHS1160L300B	268.9	302.1	302.1	362.1	360	2.1	12	4	
11.7	1	□	MHS1170L040B	13.7	42.0	42.0	102.0	100	2.0	12	3	
	5	□	MHS1170L090B	60.6	92.1	92.1	152.1	150	2.1	12	4	
	8	□	MHS1170L120B	95.7	122.1	122.1	182.1	180	2.1	12	4	
	10	□	MHS1170L150B	119.1	152.1	152.1	212.1	210	2.1	12	4	
	15	□	MHS1170L200B	177.6	202.1	202.1	262.1	260	2.1	12	4	
	19	□	MHS1170L250B	224.4	252.1	252.1	312.1	310	2.1	12	4	
	23	□	MHS1170L300B	271.2	302.1	302.1	362.1	360	2.1	12	4	
11.8	1	★	MHS1180L040B	13.8	42.0	42.0	102.0	100	2.0	12	3	
	5	★	MHS1180L090B	61.1	92.1	92.1	152.1	150	2.1	12	4	
	8	★	MHS1180L120B	96.5	122.1	122.1	182.1	180	2.1	12	4	
	10	★	MHS1180L150B	120.1	152.1	152.1	212.1	210	2.1	12	4	
	14	★	MHS1180L200B	167.3	202.1	202.1	262.1	260	2.1	12	4	
	19	★	MHS1180L250B	226.3	252.1	252.1	312.1	310	2.1	12	4	
	23	★	MHS1180L300B	273.5	302.1	302.1	362.1	360	2.1	12	4	
11.9	1	□	MHS1190L040B	13.9	42.0	42.0	102.0	100	2.0	12	3	
	5	□	MHS1190L090B	61.7	92.2	92.2	152.2	150	2.2	12	4	
	8	□	MHS1190L120B	97.4	122.2	122.2	182.2	180	2.2	12	4	
	10	□	MHS1190L150B	121.2	152.2	152.2	212.2	210	2.2	12	4	
	14	□	MHS1190L200B	168.8	202.2	202.2	262.2	260	2.2	12	4	
	19	□	MHS1190L250B	228.3	252.2	252.2	312.2	310	2.2	12	4	
	23	□	MHS1190L300B	275.9	302.2	302.2	362.2	360	2.2	12	4	
12.0	1	●	MHS1200L040B	14.1	42.1	42.1	102.1	100	2.1	12	3	
	5	●	MHS1200L090B	62.2	92.2	92.2	152.2	150	2.2	12	4	
	7	●	MHS1200L120B	86.2	122.2	122.2	182.2	180	2.2	12	4	
	10	●	MHS1200L150B	122.2	152.2	152.2	212.2	210	2.2	12	4	
	14	●	MHS1200L200B	170.2	202.2	202.2	262.2	260	2.2	12	4	
	18	●	MHS1200L250B	218.2	252.2	252.2	312.2	310	2.2	12	4	
	22	●	MHS1200L300B	266.2	302.2	302.2	362.2	360	2.2	12	4	

M

BOHREN

## SCHNITTDATENEMPFEHLUNGEN

Bohrer Durchm. DC (mm)	P				M			
	Schnittgeschw. (m/min)	Drehzahl (min <sup>-1</sup> )	Vorschub (min. – max.) (mm/U.)	Tischvorschub (mm/min)	Schnittgeschw. (m/min)	Drehzahl (min <sup>-1</sup> )	Vorschub (min. – max.) (mm/U.)	Tischvorschub (mm/min)
	Allg. Baustahl (≤180HB), C-Stahl Leg. Stahl (180–280HB)  Ck10, Ck45, 42CrMo4				Rostfreie Stähle austenitisch und martensitisch (>200HB)  X20CrNi17-2, X30Cr13			
<b>1.0</b>	40	12700	0.030 (0.020–0.040)	380	20	6400	0.030 (0.020–0.040)	190
<b>1.2</b>	50	13300	0.035 (0.025–0.050)	465	30	8000	0.035 (0.025–0.050)	280
<b>1.6</b>	60	11900	0.050 (0.030–0.065)	595	40	8000	0.050 (0.030–0.065)	400
<b>2.0</b>	70	11100	0.060 (0.040–0.080)	665	50	8000	0.060 (0.040–0.080)	480
<b>2.5</b>	80	10200	0.075 (0.050–0.100)	765	60	7600	0.075 (0.050–0.100)	570
<b>3.2</b>	80	8000	0.100 (0.070–0.130)	800	60	6000	0.100 (0.070–0.130)	600
<b>4.0</b>	80	6400	0.100 (0.090–0.110)	640	60	4800	0.090 (0.080–0.090)	430
<b>5.0</b>	80	5100	0.130 (0.110–0.140)	665	60	3800	0.110 (0.100–0.120)	420
<b>6.3</b>	80	4000	0.160 (0.140–0.180)	640	60	3000	0.140 (0.130–0.150)	420
<b>8.0</b>	80	3200	0.200 (0.180–0.230)	640	60	2400	0.170 (0.160–0.190)	410
<b>10.0</b>	80	2600	0.250 (0.220–0.280)	650	60	1900	0.220 (0.200–0.230)	420
<b>12.0</b>	80	2100	0.300 (0.270–0.340)	630	60	1600	0.260 (0.240–0.280)	415

Bohrer Durchm. DC (mm)	P				H	M			
	Schnittgeschw. (m/min)	Drehzahl (min <sup>-1</sup> )	Vorschub (min. – max.) (mm/U.)	Tischvorschub (mm/min)	Schnittgeschw. (m/min)	Drehzahl (min <sup>-1</sup> )	Vorschub (min. – max.) (mm/U.)	Tischvorschub (mm/min)	
	Vergüteter Stahl (35–45HRC), Leg. Werkzeugstahl (≤350HB)  X36CrMo17, X210Cr12, 55NiCrMoV6				Gehärteter Stahl (40–55HRC), PH Rostfreier Stahl (<450HB)  X20CrNi17-2, X30Cr13 X5CrNiCuNb164, X7CrNiAl17-7				
<b>1.0</b>	20	6400	0.025 (0.020–0.030)	160	40	12700	0.020 (0.015–0.025)	255	
<b>1.2</b>	30	8000	0.030 (0.020–0.035)	240	40	10600	0.025 (0.020–0.030)	265	
<b>1.6</b>	40	8000	0.040 (0.030–0.045)	320	50	10000	0.035 (0.025–0.040)	350	
<b>2.0</b>	50	8000	0.045 (0.035–0.060)	360	50	8000	0.040 (0.030–0.050)	320	
<b>2.5</b>	60	7600	0.060 (0.045–0.075)	455	60	7600	0.050 (0.040–0.065)	380	
<b>3.2</b>	60	6000	0.080 (0.060–0.090)	480	60	6000	0.060 (0.050–0.080)	360	
<b>4.0</b>	60	4800	0.080 (0.070–0.100)	385	60	4800	0.080 (0.060–0.100)	385	
<b>5.0</b>	60	3800	0.110 (0.090–0.130)	420	60	3800	0.100 (0.080–0.130)	380	
<b>6.3</b>	60	3000	0.130 (0.110–0.160)	390	60	3000	0.110 (0.090–0.130)	330	
<b>8.0</b>	60	2400	0.170 (0.140–0.200)	410	60	2400	0.140 (0.120–0.160)	335	
<b>10.0</b>	60	1900	0.210 (0.170–0.250)	400	60	1900	0.170 (0.140–0.200)	325	
<b>12.0</b>	60	1600	0.250 (0.210–0.300)	400	60	1600	0.210 (0.170–0.240)	335	

Bohrer Durchm. DC (mm)	H		S	
	Schnittgeschw. (m/min)	Drehzahl (min <sup>-1</sup> )	Vorschub (min. – max.) (mm/U.)	Tischvorschub (mm/min)
	Gehärteter Stahl (40–55HRC), Hitzebeständiger Stahl  X40CrMoV51, 55NiCrMoV7, Inconel <sup>®</sup> 718			
<b>1.0</b>	10	3200	0.015 (0.015–0.020)	50
<b>1.2</b>	10	2700	0.020 (0.015–0.025)	55
<b>1.6</b>	10	2000	0.025 (0.020–0.030)	50
<b>2.0</b>	20	3200	0.035 (0.025–0.040)	110
<b>2.5</b>	20	2600	0.040 (0.030–0.050)	105
<b>3.2</b>	20	2000	0.050 (0.040–0.070)	100
<b>4.0</b>	30	2400	0.070 (0.050–0.080)	170
<b>5.0</b>	30	1900	0.080 (0.060–0.100)	150
<b>6.3</b>	30	1500	0.090 (0.080–0.110)	135
<b>8.0</b>	40	1600	0.120 (0.100–0.130)	190
<b>10.0</b>	40	1300	0.150 (0.130–0.170)	195
<b>12.0</b>	40	1100	0.180 (0.150–0.200)	200

Hinweis 1) Wenn der Bohrer mit einer Länge über L/D 10 verwendet wird, müssen Pilotbohrungen als Führung zum Einsatz kommen.  
(Ohne Pilotbohrung kann der Bohrer brechen.)

Hinweis 2) Verwenden Sie den Bohrer mit der kürzesten Schneide in der gleichen Größe als Pilotbohrer.

## EINSATZHINWEISE

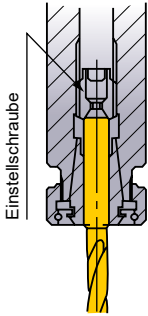
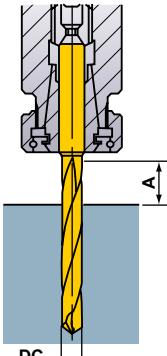
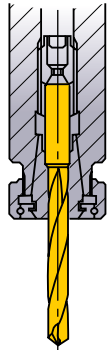
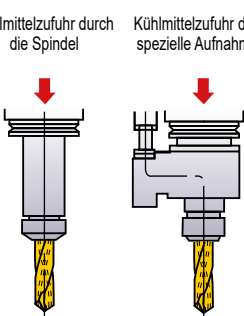
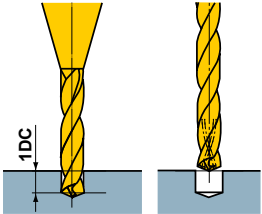
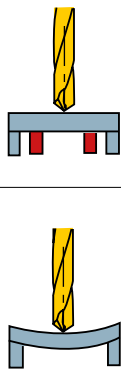
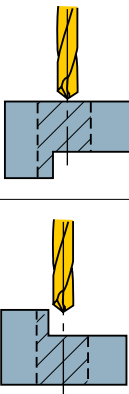
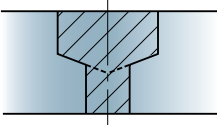
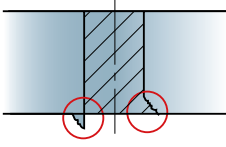
<h3>Bohrer-Aufnahme</h3>  <p>Präzisionsspannzangen können verwendet werden.</p>	<h3>Max. Bohrtiefe</h3>  <p><math>A \geq DC \times 2</math></p>	<h3>Bohrer-Einstellung</h3>  <p>Nicht auf den Nuten Spannen.</p>	<h3>Interne Kühlmittelzufuhr</h3>  <p>Kühlmittelzufuhr durch die Spindel      Kühlmittelzufuhr durch spezielle Aufnahmen.</p> <p>Der Kühlmitteldruck beträgt ca. 15 bar – 70 bar Empfohlener Kühlmitteldruck: <math>\geq 30</math> bar</p>
<h3>Bohrer-Einstellung</h3>  <p>1) Pilotbohrung 1xDC oder tiefer (DC= Bohrerdurchmesser) mittels kurzem MHS-Bohrer herstellen. 2) Je nach Anwendung kann ein kurzes Lüften beim Tieflochbohren notwendig sein.</p>	<h3>Handling mit Kühlmittel</h3> <p>1) Schmutz und Staubpartikel in altem Kühlmittel können die Kanäle verstopfen und den Kühlmittelfluss behindern. Es wird empfohlen, das Kühlmittel regelmäßig zu wechseln. 2) Feine Metallspäne können die Kühlkanalbohrung verstopfen. Zur Vorbeugung einen Filter verwenden. Bei Bohrern mit kleinem Durchmesser einen feinen Filter verwenden.</p>	<h3>Dünne Werkstücke</h3>  <p>Stützen Sie das Werkstück.</p> <p>Wenn Werkstücke verbiegen...</p>	<h3>Unterbrochene Bearbeitung</h3>  <p>Ohne Vorbearbeitung <b>OK</b> ① Reduzieren Sie den Vorschub an der unterbrochenen Stelle.</p> <p>Benötigt Vorbearbeitung ① Planen Sie die Fläche mit einem Fräser vorab.</p>
<h3>Stufenbohrungen</h3>  <p>① Vorgang in zwei Prozesse unterteilen. ② Zuerst die größere Bohrung bohren. *Werkzeuge zum Fasen und Anspiegeln können auf Bestellung gefertigt werden.</p>	<h3>Gratbildung oder Ausbrüche am Werkstück</h3>  <p>① Am Ende des Durchbruchs den Vorschub verringern. ② Tauschen Sie den Bohrer durch einen anderen mit größerem Spitzenwinkel.</p>		

## ■ BENUTZERHINWEISE FÜR MHS-TIEFLOCHBOHRER (L/D ≥ 10)

### BOHREN AUF EINER EBENEN FLÄCHE

#### ■ 1. Pilotbohrung setzen

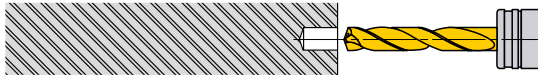

- ① Verwenden Sie den kürzestmöglichen MHS-Bohrer.
- ② Die Pilotbohrung muss ca. 1DC oder tiefer sein (auf Präzision achten).

#### ■ 2. Einfahren in die Pilotbohrung



- ① Mit niedriger Drehzahl in die Pilotbohrung einfahren. (Drehzahl 500 min<sup>-1</sup>, Vorschub 0.2 – 0.3mm/U)
- ② Tieflochbohrer 0.5–1mm vor dem Boden der Pilotbohrung stoppen.

#### ■ 3. Tieflochbohren

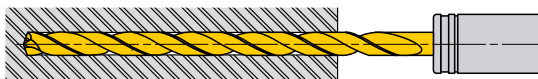

- ① Mit der empfohlenen Drehzahl und Vorschubrate in einem gleichmäßigen Zyklus (kontinuierlicher Vorschub) bis zur gewünschten Bohrungstiefe bohren (ohne zu lüften).

#### ■ 4. Herausfahren des Tieflochbohrers

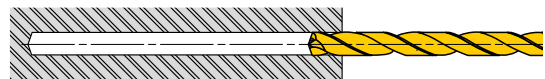

- ① Reduzieren Sie nach Erreichen der Bohrtiefe die Drehzahl. (Drehzahl 500min<sup>-1</sup>)
- ② Bohrer bis zur Tiefe der Pilotbohrung (1DC) bei einem Vorschub von 3000mm/min zurückfahren.
- ③ Fahren Sie den Bohrer anschließend mit einem Vorschub von 0.2–0.3mm/U ganz heraus.

### BOHREN AUF UNEBENEN FLÄCHEN

#### ■ 1. Anspiegeln

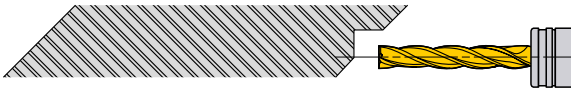

- ① Bearbeiten Sie die unebene Fläche mit einem geeigneten Schaffräser oder Flachbohrer, der zum Anspiegeln geeignet ist. Der Durchmesser der Planfläche muss mindestens so groß wie der Durchmesser des Tieflochbohrers sein (auf Durchmessertoleranzen achten).

#### ■ 2. Pilotbohrung setzen



- ① Verwenden Sie den kürzestmöglichen MHS-Bohrer.
- ② Die Pilotbohrung muss ca. 1DC oder tiefer sein (auf Präzision achten).

#### ■ 3. Einfahren in die Pilotbohrung



- ① Mit niedriger Drehzahl in die Pilotbohrung einfahren. (Drehzahl 500 min<sup>-1</sup>, Vorschub 0.2 – 0.3mm/U)
- ② Tieflochbohrer 0.5–1mm vor dem Boden der Pilotbohrung stoppen.

#### ■ 4. Tieflochbohren

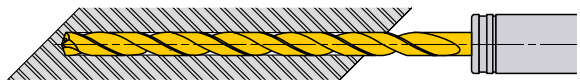

- ① Mit der empfohlenen Drehzahl und Vorschubrate in einem gleichmäßigen Zyklus (kontinuierlicher Vorschub) bis zur gewünschten Bohrungstiefe bohren (ohne zu lüften).

#### ■ 5. Durchbohren

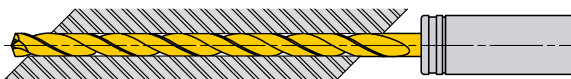

- ① Reduzieren Sie den Vorschub beim Austritt aus der Bohrung, um Beschädigungen an der Schneidkante zu vermeiden.

#### ■ 6. Herausfahren des Bohrers



- ① Reduzieren Sie nach Erreichen der Bohrtiefe die Drehzahl. (Drehzahl 500min<sup>-1</sup>)
- ② Bohrer bis zur Tiefe der Pilotbohrung (1DC) bei einem Vorschub von 3000mm/min zurückfahren.
- ③ Fahren Sie den Bohrer anschließend mit einem Vorschub von 0.2–0.3mm/U ganz heraus.



# BOHREN (SCHNEIDKRONEN AUSFÜHRUNG)

# STAW

- Wellenförmige Schneidkante für optimale Spankontrolle.
- Hochstabiles Einspannsystem bietet Stabilität und Zuverlässigkeit beim Bohren kleiner Löcher.



HARTMETALL

- P
- M
- K
- N
- S
- H

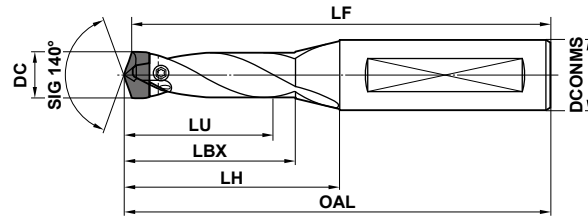

M  
BOHREN

## HALTER FÜR SCHNEIDKRONEN

DC (mm)	Bohrtiefe (LD)	Halter		Abmessungen (mm)						F Schlüssel	Schneidkrone		
		Bestellnummer	Lager	LU	LBX	LH	OAL	LF	DCONMS		DC (mm)	Bestellnummer	Lager VP15TF
10.0   10.4	1.5	STAWSS1000S16	●	16.8	23.8	33.8	81.8	80	16	TIP06F	10.0	* STAWN1000TH STAWK1000TG	●
	3	STAWSN1000S16	●	31.8	38.8	48.8	96.8	95	16	TIP06F	10.1	STAWN1010TH STAWK1010TG	●
	5	STAWMN1000S16	●	51.8	58.8	68.8	116.8	115	16	TIP06F	10.2	STAWN1020TH STAWK1020TG	●
	8	STAWLN1000S16	●	81.8	88.8	98.8	146.8	145	16	TIP06F	10.3 10.4	STAWN1030TH STAWK1030TG STAWN1040TH STAWK1040TG	●
10.5   10.9	1.5	STAWSS1050S16	●	17.7	23.9	33.9	81.9	80	16	TIP06F	10.5	* STAWN1050TH STAWK1050TG	●
	3	STAWSN1050S16	●	33.4	38.9	48.9	96.9	95	16	TIP06F	10.6	STAWN1060TH STAWK1060TG	●
	5	STAWMN1050S16	●	54.4	58.9	68.9	116.9	115	16	TIP06F	10.7	STAWN1070TH STAWK1070TG	●
	8	STAWLN1050S16	●	85.9	88.9	98.9	146.9	145	16	TIP06F	10.8 10.9	STAWN1080TH STAWK1080TG STAWN1090TH STAWK1090TG	●
11.0   11.4	1.5	STAWSS1100S16	●	18.5	27.0	38.0	86.0	84	16	TIP06F	11.0	* STAWN1100TH STAWK1100TG	●
	3	STAWSN1100S16	●	35.0	43.0	54.0	102.0	100	16	TIP06F	11.1	STAWN1110TH STAWK1110TG	●
	5	STAWMN1100S16	●	57.0	68.0	79.0	127.0	125	16	TIP06F	11.2	STAWN1120TH STAWK1120TG	●
	8	STAWLN1100S16	●	90.0	98.0	109.0	157.0	155	16	TIP06F	11.3 11.4	STAWN1130TH STAWK1130TG STAWN1140TH STAWK1140TG	●
11.5   11.9	1.5	STAWSS1150S16	●	19.4	27.1	38.1	86.1	84	16	TIP06F	11.5	* STAWN1150TH STAWK1150TG	●
	3	STAWSN1150S16	●	36.6	43.1	54.1	102.1	100	16	TIP06F	11.6	STAWN1160TH STAWK1160TG	●
	5	STAWMN1150S16	●	59.6	68.1	79.1	127.1	125	16	TIP06F	11.7	STAWN1170TH STAWK1170TG	●
	8	STAWLN1150S16	●	94.1	98.1	109.1	157.1	155	16	TIP06F	11.8 11.9	STAWN1180TH STAWK1180TG STAWN1190TH STAWK1190TG	●
12.0   12.4	1.5	STAWSS1200S16	●	20.2	29.2	41.2	89.2	87	16	TIP06F	12.0	* STAWN1200TH STAWK1200TG	●
	3	STAWSN1200S16	●	38.2	47.2	59.2	107.2	105	16	TIP06F	12.1	STAWN1210TH STAWK1210TG	●
	5	STAWMN1200S16	●	62.2	72.2	84.2	132.2	130	16	TIP06F	12.2	STAWN1220TH STAWK1220TG	●
	8	STAWLN1200S16	●	98.2	107.2	119.2	167.2	165	16	TIP06F	12.3 12.4	STAWN1230TH STAWK1230TG STAWN1240TH STAWK1240TG	●

Hinweis 1) Die obigen Abmessungen (\*) beziehen für montierte Schneidkrone auf Grundkörpern.

Hinweis 2) Für Sonderabmasse (z.B. andere Durchmesser und Längen) setzen Sie sich bitte mit uns Verbindung.

● : Lagerstandard. (Verpackungseinheit: 1Stk.)

WSP BESCHREIBUNG > M142  
 SCHNITTBEDINGUNGEN > M144  
 EINSATZ HINWEISE > M145

ERSATZTEILE > N001  
 TECHNISCHE DATEN > P001

M139

# BOHREN (SCHNEIDKRONEN AUSFÜHRUNG)

# STAW

HARTMETALL

M

BOHREN

DC (mm)	Bohrtiefe (L/D)	Halter		Abmessungen (mm)						F W		Schneidkrone		
		Bestellnummer	Lager	LU	LBX	LH	OAL	LF	DCONMS	Schlüssel	DC (mm)	Bestellnummer	Lager VP15TF	
12.5   12.9	1.5	STAWSS1250S16	●	21.1	29.3	41.3	89.3	87	16	TIP06F	12.5	* STAWN1250TH STAWK1250TG	●	
	3	STAWSN1250S16	●	39.8	47.3	59.3	107.3	105	16	TIP06F	12.6	STAWN1260TH STAWK1260TG	●	
	5	STAWMN1250S16	●	64.8	72.3	84.3	132.3	130	16	TIP06F	12.7	STAWN1270TH STAWK1270TG	●	
	8	STAWLN1250S16	●	102.3	107.3	119.3	167.3	165	16	TIP06F	12.8	STAWN1280TH STAWK1280TG	●	
13.0   13.4	1.5	STAWSS1300S16	●	21.9	32.4	45.4	93.4	91	16	TIP08W	13.0	* STAWN1300TH STAWK1300TG	●	
	3	STAWSN1300S16	●	41.4	51.4	64.4	112.4	110	16	TIP08W	13.1	STAWN1310TH STAWK1310TG	●	
	5	STAWMN1300S16	●	67.4	76.4	89.4	137.4	135	16	TIP08W	13.2	STAWN1320TH STAWK1320TG	●	
	8	STAWLN1300S16	●	106.4	116.4	129.4	177.4	175	16	TIP08W	13.3	STAWN1330TH STAWK1330TG	●	
13.5   13.9	1.5	STAWSS1350S16	●	22.8	32.5	45.5	93.5	91	16	TIP08W	13.5	* STAWN1350TH STAWK1350TG	●	
	3	STAWSN1350S16	●	43.0	51.5	64.5	112.5	110	16	TIP08W	13.6	STAWN1360TH STAWK1360TG	●	
	5	STAWMN1350S16	●	70.0	76.5	89.5	137.5	135	16	TIP08W	13.7	STAWN1370TH STAWK1370TG	●	
	8	STAWLN1350S16	●	110.5	116.5	129.5	177.5	175	16	TIP08W	13.8	STAWN1380TH STAWK1380TG	●	
14.0   14.4	1.5	STAWSS1400S16	●	23.5	33.5	47.5	95.5	93	16	TIP08W	14.0	* STAWN1400TH STAWK1400TG	●	
	3	STAWSN1400S16	●	44.5	55.5	69.5	117.5	115	16	TIP08W	14.1	STAWN1410TH STAWK1410TG	●	
	5	STAWMN1400S16	●	72.5	85.5	99.5	147.5	145	16	TIP08W	14.2	STAWN1420TH STAWK1420TG	●	
	8	STAWLN1400S16	●	114.5	124.5	139.5	187.5	185	16	TIP08W	14.3	STAWN1430TH STAWK1430TG	●	
14.5   14.9	1.5	STAWSS1450S16	●	24.4	33.6	47.6	95.6	93	16	TIP08W	14.5	* STAWN1450TH STAWK1450TG	●	
	3	STAWSN1450S16	●	46.1	55.6	69.6	117.6	115	16	TIP08W	14.6	STAWN1460TH STAWK1460TG	●	
	5	STAWMN1450S16	●	75.1	85.6	99.6	147.6	145	16	TIP08W	14.7	STAWN1470TH STAWK1470TG	●	
	8	STAWLN1450S16	●	118.6	124.6	139.6	187.6	185	16	TIP08W	14.8	STAWN1480TH STAWK1480TG	●	
15.0   15.4	1.5	STAWSS1500S20	●	25.2	35.7	50.7	100.7	98	20	TIP08W	15.0	* STAWN1500TH STAWK1500TG	●	
	3	STAWSN1500S20	●	47.7	62.7	77.7	127.7	125	20	TIP08W	15.1	STAWN1510TH STAWK1510TG	●	
	5	STAWMN1500S20	●	77.7	92.7	107.7	157.7	155	20	TIP08W	15.2	STAWN1520TH STAWK1520TG	●	
	8	STAWLN1500S20	●	122.7	132.7	150.7	200.7	198	20	TIP08W	15.3	STAWN1530TH STAWK1530TG	●	
										15.4	STAWN1540TH STAWK1540TG	●		

Hinweis 1) Die obigen Abmessungen (\*) beziehen sich auf die Montage mit Schneidkrone.

Hinweis 2) Für Sonderabmasse (z. B. andere Durchmesser und Längen) setzen Sie sich bitte mit uns Verbindung.

● : Lagerstandard. (Verpackungseinheit: 1Stk.)

DC (mm)	Bohrtiefe (L/D)	Halter		Abmessungen (mm)						W  Schlüssel	Schneidkrone		
		Bestellnummer	Lager	LU	LBX	LH	OAL	LF	DCONMS		DC (mm)	Bestellnummer	Lager VP15TF
15.5   16.4	1.5	STAWSS1600S20	●	26.1	36.8	52.8	102.8	100	20	TIP10W	15.5	* STAWN1550T	●
												STAWK1550TG	
											15.6	STAWN1560T	●
											15.7	STAWN1570T	●
												STAWK1570TG	
											15.8	STAWN1580T	●
												STAWK1580TG	
											15.9	STAWN1590T	●
												STAWK1590TG	
											16.0	STAWN1600T	●
												STAWK1600TG	
										16.1	STAWN1610T	●	
											STAWK1610TG		
										16.2	STAWN1620T	●	
											STAWK1620TG		
										16.3	STAWN1630T	●	
											STAWK1630TG		
										16.4	STAWN1640T	●	
											STAWK1640TG		
16.5   17.4	1.5	STAWSS1700S20	●	27.8	39.0	56.0	106.0	103	20	TIP10W	16.5	* STAWN1650T	●
												STAWK1650TG	
											16.6	STAWN1660T	●
												STAWK1660TG	
											16.7	STAWN1670T	●
												STAWK1670TG	
											16.8	STAWN1680T	●
												STAWK1680TG	
											16.9	STAWN1690T	●
												STAWK1690TG	
											17.0	STAWN1700T	●
												STAWK1700TG	
										17.1	STAWN1710T	●	
											STAWK1710TG		
										17.2	STAWN1720T	●	
											STAWK1720TG		
										17.3	STAWN1730T	●	
											STAWK1730TG		
										17.4	STAWN1740T	●	
											STAWK1740TG		
17.5   18.4	1.5	STAWSS1800S20	●	29.5	40.2	58.2	108.2	105	20	TIP10W	17.5	* STAWN1750T	●
												STAWK1750TG	
											17.6	STAWN1760T	●
												STAWK1760TG	
											17.7	STAWN1770T	●
												STAWK1770TG	
											17.8	STAWN1780T	●
												STAWK1780TG	
											17.9	STAWN1790T	●
												STAWK1790TG	
											18.0	STAWN1800T	●
												STAWK1800TG	
										18.1	STAWN1810T	●	
											STAWK1810TG		
										18.2	STAWN1820T	●	
											STAWK1820TG		
										18.3	STAWN1830T	●	
											STAWK1830TG		
										18.4	STAWN1840T	●	
											STAWK1840TG		

WSP BESCHREIBUNG > M142  
 SCHNITTBEDINGUNGEN > M144  
 EINSATZ HINWEISE > M145

ERSATZTEILE > N001  
 TECHNISCHE DATEN > P001

# BOHREN (SCHNEIDKRONEN AUSFÜHRUNG)

HARTMETALL

# STAW

## Schneidkrone

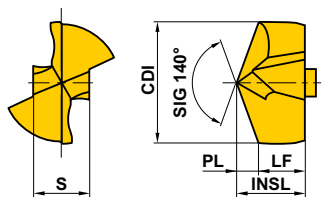

M

BOHREN

Bestellnummer	Beschichtet		Abmessungen (mm)					Halter für Schneidkrone
	VP15TF		CDI	INSL	LF	PL	S	
STAWN1000TH	●		10.0	5.6	3.8	1.8	4.6	STAWSS1000S16 STAWSN1000S16 STAWMN1000S16 STAWLN1000S16
STAWN1010TH	●		10.1	5.6	3.8	1.8	4.6	
STAWN1020TH	●		10.2	5.7	3.8	1.9	4.6	
STAWN1030TH	●		10.3	5.7	3.8	1.9	4.6	
STAWN1040TH	●		10.4	5.7	3.8	1.9	4.6	
STAWN1050TH	●		10.5	5.9	4.0	1.9	4.8	STAWSS1050S16 STAWSN1050S16 STAWMN1050S16 STAWLN1050S16
STAWN1060TH	●		10.6	5.9	4.0	1.9	4.8	
STAWN1070TH	●		10.7	5.9	4.0	1.9	4.8	
STAWN1080TH	●		10.8	6.0	4.0	2.0	4.8	
STAWN1090TH	●		10.9	6.0	4.0	2.0	4.8	
STAWN1100TH	●		11.0	6.2	4.2	2.0	5.1	STAWSS1100S16 STAWSN1100S16 STAWMN1100S16 STAWLN1100S16
STAWN1110TH	●		11.1	6.2	4.2	2.0	5.1	
STAWN1120TH	●		11.2	6.2	4.2	2.0	5.1	
STAWN1130TH	●		11.3	6.3	4.2	2.1	5.1	
STAWN1140TH	●		11.4	6.3	4.2	2.1	5.1	
STAWN1150TH	●		11.5	6.5	4.4	2.1	5.3	STAWSS1150S16 STAWSN1150S16 STAWMN1150S16 STAWLN1150S16
STAWN1160TH	●		11.6	6.5	4.4	2.1	5.3	
STAWN1170TH	●		11.7	6.5	4.4	2.1	5.3	
STAWN1180TH	●		11.8	6.5	4.4	2.1	5.3	
STAWN1190TH	●		11.9	6.6	4.4	2.2	5.3	
STAWN1200TH	●		12.0	6.8	4.6	2.2	5.5	STAWSS1200S16 STAWSN1200S16 STAWMN1200S16 STAWLN1200S16
STAWN1210TH	●		12.1	6.8	4.6	2.2	5.5	
STAWN1220TH	●		12.2	6.8	4.6	2.2	5.5	
STAWN1230TH	●		12.3	6.8	4.6	2.2	5.5	
STAWN1240TH	●		12.4	6.9	4.6	2.3	5.5	
STAWN1250TH	●		12.5	7.1	4.8	2.3	5.8	STAWSS1250S16 STAWSN1250S16 STAWMN1250S16 STAWLN1250S16
STAWN1260TH	●		12.6	7.1	4.8	2.3	5.8	
STAWN1270TH	●		12.7	7.1	4.8	2.3	5.8	
STAWN1280TH	●		12.8	7.1	4.8	2.3	5.8	
STAWN1290TH	●		12.9	7.1	4.8	2.3	5.8	
STAWN1300TH	●		13.0	7.3	4.9	2.4	6.0	STAWSS1300S16 STAWSN1300S16 STAWMN1300S16 STAWLN1300S16
STAWN1310TH	●		13.1	7.3	4.9	2.4	6.0	
STAWN1320TH	●		13.2	7.3	4.9	2.4	6.0	
STAWN1330TH	●		13.3	7.3	4.9	2.4	6.0	
STAWN1340TH	●		13.4	7.3	4.9	2.4	6.0	
STAWN1350TH	●		13.5	7.6	5.1	2.5	6.2	STAWSS1350S16 STAWSN1350S16 STAWMN1350S16 STAWLN1350S16
STAWN1360TH	●		13.6	7.6	5.1	2.5	6.2	
STAWN1370TH	●		13.7	7.6	5.1	2.5	6.2	
STAWN1380TH	●		13.8	7.6	5.1	2.5	6.2	
STAWN1390TH	●		13.9	7.6	5.1	2.5	6.2	

● : Lagerstandard. (Verpackungseinheit: 1Stk.)

Bestellnummer	Beschichtet		Abmessungen (mm)					Halter für Schneidkrone
	VPI	15TF	CDI	INSL	LF	PL	S	
STAWN1400TH	●		14.0	7.8	5.3	2.5	6.4	STAWSS1400S16 STAWSN1400S16 STAWMN1400S16 STAWLN1400S16
STAWN1410TH	●		14.1	7.9	5.3	2.6	6.4	
STAWN1420TH	●		14.2	7.9	5.3	2.6	6.4	
STAWN1430TH	●		14.3	7.9	5.3	2.6	6.4	
STAWN1440TH	●		14.4	7.9	5.3	2.6	6.4	
STAWN1450TH	●		14.5	8.1	5.5	2.6	6.7	STAWSS1450S16 STAWSN1450S16 STAWMN1450S16 STAWLN1450S16
STAWN1460TH	●		14.6	8.2	5.5	2.7	6.7	
STAWN1470TH	●		14.7	8.2	5.5	2.7	6.7	
STAWN1480TH	●		14.8	8.2	5.5	2.7	6.7	
STAWN1490TH	●		14.9	8.2	5.5	2.7	6.7	
STAWN1500TH	●		15.0	8.4	5.7	2.7	6.9	STAWSS1500S20 STAWSN1500S20 STAWMN1500S20 STAWLN1500S20
STAWN1510TH	●		15.1	8.4	5.7	2.7	6.9	
STAWN1520TH	●		15.2	8.5	5.7	2.8	6.9	
STAWN1530TH	●		15.3	8.5	5.7	2.8	6.9	
STAWN1540TH	●		15.4	8.5	5.7	2.8	6.9	
STAWN1550T	●		15.5	8.7	5.9	2.8	7.1	STAWSS1600S20 STAWSN1600S20 STAWMN1600S20 STAWLN1600S20
STAWN1560T	●		15.6	8.7	5.9	2.8	7.1	
STAWN1570T	●		15.7	8.8	5.9	2.9	7.1	
STAWN1580T	●		15.8	8.8	5.9	2.9	7.1	
STAWN1590T	●		15.9	8.8	5.9	2.9	7.1	
STAWN1600T	●		16.0	8.8	5.9	2.9	7.1	
STAWN1610T	●		16.1	8.8	5.9	2.9	7.1	
STAWN1620T	●		16.2	8.8	5.9	2.9	7.1	
STAWN1630T	●		16.3	8.9	5.9	3.0	7.1	
STAWN1640T	●		16.4	8.9	5.9	3.0	7.1	
STAWN1650T	●		16.5	9.3	6.3	3.0	7.6	STAWSS1700S20 STAWSN1700S20 STAWMN1700S20 STAWLN1700S20
STAWN1660T	●		16.6	9.3	6.3	3.0	7.6	
STAWN1670T	●		16.7	9.3	6.3	3.0	7.6	
STAWN1680T	●		16.8	9.4	6.3	3.1	7.6	
STAWN1690T	●		16.9	9.4	6.3	3.1	7.6	
STAWN1700T	●		17.0	9.4	6.3	3.1	7.6	
STAWN1710T	●		17.1	9.4	6.3	3.1	7.6	
STAWN1720T	●		17.2	9.4	6.3	3.1	7.6	
STAWN1730T	●		17.3	9.4	6.3	3.1	7.6	
STAWN1740T	●		17.4	9.5	6.3	3.2	7.6	
STAWN1750T	●		17.5	9.9	6.7	3.2	8.1	STAWSS1800S20 STAWSN1800S20 STAWMN1800S20 STAWLN1800S20
STAWN1760T	●		17.6	9.9	6.7	3.2	8.1	
STAWN1770T	●		17.7	9.9	6.7	3.2	8.1	
STAWN1780T	●		17.8	9.9	6.7	3.2	8.1	
STAWN1790T	●		17.9	10.0	6.7	3.3	8.1	
STAWN1800T	●		18.0	10.0	6.7	3.3	8.1	
STAWN1810T	●		18.1	10.0	6.7	3.3	8.1	
STAWN1820T	●		18.2	10.0	6.7	3.3	8.1	
STAWN1830T	●		18.3	10.0	6.7	3.3	8.1	
STAWN1840T	●		18.4	10.0	6.7	3.3	8.1	

## FASENBREITE

Wenn eine Schneidkrone mit einer anderen Verfassung bevorzugt wird, verwenden Sie bitte folgende Symbole bei der Bestellnummer.

(Schneidkronen Bestellnummer)

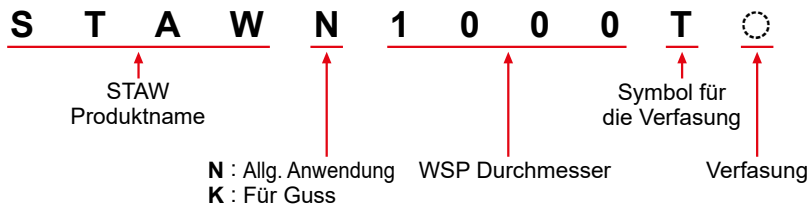

(Verfassungen)

Verfassung	Fasenbreite (mm)
F	0
G	0.02–0.05
H	0.05–0.10
- (Standard)	0.10–0.15
K	0.15–0.20
S	0.20–0.25
M	0.25–0.30

## SCHNITTDATENEMPFEHLUNGEN

Material	Bohrer Durchm. Bedingung Härte	Ø 10.0–Ø 12.9		Ø 13.0–Ø 13.9		Ø 14.0–Ø 15.4		Ø 15.5–Ø 18.4	
		Schnittgeschw. (m/min)	Vorschub (mm/U.)	Schnittgeschw. (m/min)	Vorschub (mm/U.)	Schnittgeschw. (m/min)	Vorschub (mm/U.)	Schnittgeschw. (m/min)	Vorschub (mm/U.)
<b>P</b> Allg. Baustahl	≤180HB	80 (60–100)	0.20 (0.15–0.25)	90 (70–110)	0.25 (0.20–0.30)	100 (80–120)	0.30 (0.25–0.35)	100 (80–120)	0.35 (0.25–0.40)
	180–280HB	80 (60–100)	0.20 (0.15–0.25)	90 (70–110)	0.25 (0.20–0.30)	100 (80–120)	0.30 (0.25–0.35)	100 (80–120)	0.35 (0.25–0.40)
	280–350HB	70 (60–90)	0.20 (0.15–0.25)	80 (60–100)	0.25 (0.20–0.30)	90 (70–110)	0.25 (0.20–0.30)	90 (70–110)	0.30 (0.20–0.35)
<b>M</b> Rostfreier Stahl	≤200HB	40 (30–50)	0.13 (0.10–0.16)	50 (40–60)	0.15 (0.12–0.18)	60 (50–70)	0.17 (0.14–0.20)	60 (50–70)	0.17 (0.14–0.20)
<b>K</b> Guss	Zugfestigkeit ≤350MPa	80 (60–100)	0.20 (0.15–0.25)	90 (70–110)	0.25 (0.20–0.30)	100 (80–120)	0.30 (0.25–0.35)	120 (80–140)	0.45 (0.35–0.55)
	Duktiler Guss Zugfestigkeit ≤450MPa	70 (60–90)	0.20 (0.15–0.25)	80 (60–100)	0.25 (0.20–0.30)	90 (70–110)	0.30 (0.25–0.35)	100 (80–120)	0.35 (0.25–0.40)

Hinweis 1) Bei Verwendung von L/D 1.5 Bohrern ist es möglich, die Vorschubgeschwindigkeit um ca. 20 % zu erhöhen.

Hinweis 2) Bei Verwendung von L/D 8 Bohrern sollte die Schnittgeschwindigkeit um ca. 20 % reduziert werden.

Hinweis 3) Bei Verwendung von L/D 8 Bohrern wird der Einsatz einer Pilotbohrung empfohlen.

Hinweis 4) Bitte verwenden Sie interne Kühlmittelzufuhr bei rostfreien Stählen. Bitte keine MMS (Minimalmengenschmierung) einsetzen.

## BENUTZERHINWEIS

### ■ SCHNEIDKRONEN-MONTAGE

1. Bevor Sie die Schneidkrone in den Halter einsetzen, vergewissern Sie sich, dass sich in der Halteröffnung bzw. in dem Schlitz weder Fremdkörper noch Schmutz befinden. Reinigen Sie den Halter gegebenenfalls mit Druckluft.
2. Verwenden Sie den beiliegenden Schlüssel, um die innere Schraube zu lockern und die Spitze des Halters zu öffnen. Setzen Sie dann die WSP in die Halteröffnung ein wie in Abb. 1 gezeigt.  
\*Achten Sie darauf, dass der Schlüssel beim Festziehen der Schraube einen engen Kontakt mit dem Kopf der Schraube hat.
3. Nachdem Sie die Schneidkrone in die Halteröffnung eingesetzt haben, ziehen Sie die innere Schraube fest und drücken Sie gleichzeitig die WSP in die Tasche (wie in Abb. 2 gezeigt), damit dieser richtig sitzt und sicher gespannt ist.  
\*Achten Sie darauf, dass der Schlüssel beim Festziehen der Schraube einen engen Kontakt mit dem Kopf der Schraube hat.



Bild 1



Bild 2

Spannschraube mit Drehmoment gemäß nachfolgender Tabelle festziehen.

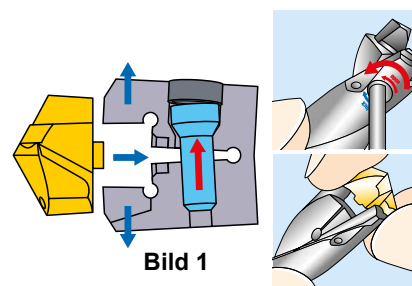
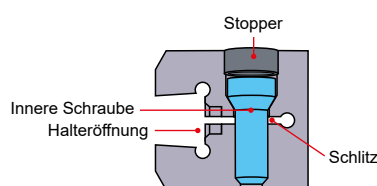

Bohrer Durchm. (mm)	Drehmoment	
	N•m	
10 – 12.9	1	
13 – 15.4	2	
15.5 – 18.4	2.5	

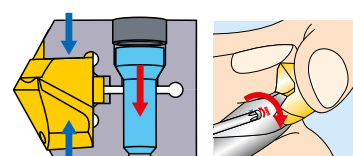
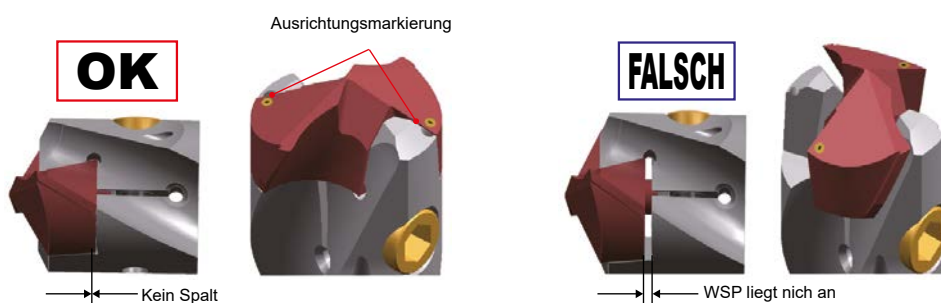
4. Vergewissern Sie sich, dass kein Spalt zwischen der Unterseite der WSP und der Halteröffnung besteht.



Hinweis 1) Wenn die Schneidkrone unzureichend oder nicht richtig eingespannt wird, kann die Bohrleistung nachlassen und/oder der Bohrer brechen. Achten Sie daher beim Einsetzen darauf, dass die Ausrichtungsmarkierungen am Halter und an der Schneidkrone übereinstimmen. Verwenden Sie bei der Bearbeitung Sicherheitsvorrichtungen und eine Schutzbrille.

## ERSATZTEILE

Halter für Schneidkronen	Set-Bestellnummer (Innere Schraube und stopper)		
		Innere Schraube	Stopper
<b>STAWSS/SN/MN/LN1000S16</b>	WS203107TPS-35LH	WS203107TPS	WS35LH
<b>STAWSS/SN/MN/LN1050S16</b>	WS203107TPS-35LH	WS203107TPS	WS35LH
<b>STAWSS/SN/MN/LN1100S16</b>	WS203108TPS-35LH	WS203108TPS	WS35LH
<b>STAWSS/SN/MN/LN1150S16</b>	WS203108TPS-35LH	WS203108TPS	WS35LH
<b>STAWSS/SN/MN/LN1200S16</b>	WS203108TPS-35LH	WS203108TPS	WS35LH
<b>STAWSS/SN/MN/LN1250S16</b>	WS203108TPS-35LH	WS203108TPS	WS35LH
<b>STAWSS/SN/MN/LN1300S16</b>	WS253909TPS-45LH	WS253909TPS	WS45LH
<b>STAWSS/SN/MN/LN1350S16</b>	WS253909TPS-45LH	WS253909TPS	WS45LH
<b>STAWSS/SN/MN/LN1400S16</b>	WS253909TPS-45LH	WS253909TPS	WS45LH
<b>STAWSS/SN/MN/LN1450S16</b>	WS253909TPS-45LH	WS253909TPS	WS45LH
<b>STAWSS/SN/MN/LN1500S20</b>	WS253909TPS-45LH	WS253909TPS	WS45LH
<b>STAWSS/SN/MN/LN1600S20</b>	WS304912TPS-55LH	WS304912TPS	WS55LH
<b>STAWSS/SN/MN/LN1700S20</b>	WS304912TPS-55LH	WS304912TPS	WS55LH
<b>STAWSS/SN/MN/LN1800S20</b>	WS304912TPS-55LH	WS304912TPS	WS55LH

Hinweis 1) Das KIT beinhaltet Spannschraube, Stopper und Bedienungsanleitung. Wechseln Sie bitte die Ersatzteile entsprechend der beiliegenden Anleitung.



# Notizen

---

A series of horizontal dashed lines for writing notes, spanning the width of the page.

# BOHREN (SCHNEIDKRONEN AUSFÜHRUNG)

HARTMETALL

# TAW

- Wellenförmige Schneidkante für optimale Spankontrolle.
- Positionsrillen für optimalen Rundlauf und Wiederholgenauigkeit.
- Einfacher WSP-Tausch.



P M K N S H

(Allg. Anwendung)

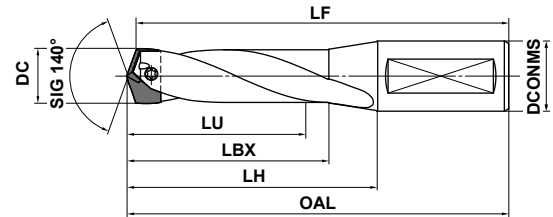





M  
BOHREN

## ■ Halter für Schneidkronen

DC (mm)	Bohrtiefe (L/D)	Halter		Abmessungen (mm)						Spannschraube	Schlüssel	Schlitz-Reiniger	Kupfer-paste	Schneidkrone			
		Bestellnummer	Lager	LU	LBX	LH	OAL	LF	DCONMS					DC (mm)	Bestellnummer	Lager	
														VP15TF	VP10H		
18.5 - 19.4	3	TAWSN1900S25	●	58.9	71.4	102.4	158.4	155.0	25	WS304517T	TKY10T	WPT4405	MK1KS	18.5	* TAWNH1850T	●	<input type="checkbox"/>
															TAWKH1850TG		
														18.6	TAWNH1860T	●	<input type="checkbox"/>
															TAWKH1860TG		
														18.7	TAWNH1870T	●	<input type="checkbox"/>
															TAWKH1870TG		
	5	TAWMN1900S25	●	95.9	110.4	137.4	193.4	190.0	25	WS304517T	TKY10T	WPT4405	MK1KS	18.8	TAWNH1880T	●	<input type="checkbox"/>
															TAWKH1880TG		
														18.9	TAWNH1890T	●	<input type="checkbox"/>
															TAWKH1890TG		
														19.0	TAWNH1900T	●	<input type="checkbox"/>
															TAWKH1900TG		
8	TAWLN1900S25	●	151.4	165.4	188.4	244.4	241.0	25	WS304517T	TKY10T	WPT4405	MK1KS	19.1	TAWNH1910T	●	<input type="checkbox"/>	
														TAWKH1910TG			
													19.2	TAWNH1920T	●	<input type="checkbox"/>	
														TAWKH1920TG			
													19.3	TAWNH1930T	●	<input type="checkbox"/>	
														TAWKH1930TG			
19.4	TAWNH1940T	●	<input type="checkbox"/>														
	TAWKH1940TG																
19.5 - 20.4	3	TAWSN2000S25	●	62.0	75.5	102.5	158.5	155.0	25	WS304518T	TKY10T	WPT4405	MK1KS	19.5	* TAWNH1950T	●	<input type="checkbox"/>
															TAWKH1950TG		
														19.6	TAWNH1960T	●	<input type="checkbox"/>
															TAWKH1960TG		
														19.7	TAWNH1970T	●	<input type="checkbox"/>
															TAWKH1970TG		
	19.8	TAWNH1980T	●	<input type="checkbox"/>													
		TAWKH1980TG															
	5	TAWMN2000S25	●	101.0	116.5	142.5	198.5	195.0	25	WS304518T	TKY10T	WPT4405	MK1KS	19.9	TAWNH1990T	●	<input type="checkbox"/>
															TAWKH1990TG		
														20.0	TAWNH2000T	●	<input type="checkbox"/>
															TAWKH2000TG		
														20.1	TAWNH2010T	<input type="checkbox"/>	<input type="checkbox"/>
															TAWKH2010TG		
	20.2	TAWNH2020T	<input type="checkbox"/>	<input type="checkbox"/>													
		TAWKH2020TG															
	8	TAWLN2000S25	●	159.5	173.5	196.5	252.5	249.0	25	WS304518T	TKY10T	WPT4405	MK1KS	20.3	TAWNH2030T	<input type="checkbox"/>	<input type="checkbox"/>
															TAWKH2030TG		
20.4														TAWNH2040T	<input type="checkbox"/>	<input type="checkbox"/>	
														TAWKH2040TG			

Hinweis 1) Die obigen Abmessungen (\*) beziehen sich für montierte Schneidplatten auf Grundkörpern.  
 Hinweis 2) Bei Bedarf von abweichenden Geometrien setzen Sie sich mit uns in Verbindung.  
 (Andere Durchmesser und Längen können bestellt werden).

● : Lagerstandard. □ : Herstellung nur auf Anfrage  
 (Verpackungseinheit: 1Stk.)

DC (mm)	Bohrtiefe (L/D)	Halter		Abmessungen (mm)						D CONIMS					Schneidkrone			
		Bestellnummer	Lager	LU	LBX	LH	OAL	LF	DC						Bestellnummer	Lager		
																VP15TF	VP10H	
20.5 - 21.4	3	TAWSN2100S25	●	65.2	78.7	102.7	158.7	155.0	25	WS304518T	TKY10T	WPT4405	MK1KS	20.5	* TAWNH2050T	●	<input type="checkbox"/>	
															TAWKH2050TG			
														20.6	TAWNH2060T	<input type="checkbox"/>	<input type="checkbox"/>	
	5	TAWMN2100S25	●	106.2	121.7	142.7	198.7	195.0	25	WS304518T	TKY10T	WPT4405	MK1KS		TAWKH2060TG			
														20.7	TAWNH2070T	<input type="checkbox"/>	<input type="checkbox"/>	
															TAWKH2070TG			
														20.8	TAWNH2080T	<input type="checkbox"/>	<input type="checkbox"/>	
															TAWKH2080TG			
														20.9	TAWNH2090T	<input type="checkbox"/>	<input type="checkbox"/>	
															TAWKH2090TG			
														21.0	TAWNH2100T	●	<input type="checkbox"/>	
															TAWKH2100TG			
21.1	TAWNH2110T	<input type="checkbox"/>	<input type="checkbox"/>															
	TAWKH2110TG																	
8	TAWLN2100S25	●	167.7	181.7	205.7	261.7	258.0	25	WS304518T	TKY10T	WPT4405	MK1KS	21.2	TAWNH2120T	<input type="checkbox"/>	<input type="checkbox"/>		
														TAWKH2120TG				
													21.3	TAWNH2130T	<input type="checkbox"/>	<input type="checkbox"/>		
														TAWKH2130TG				
													21.4	TAWNH2140T	<input type="checkbox"/>	<input type="checkbox"/>		
														TAWKH2140TG				
21.5 - 22.4	3	TAWSN2200S25	●	68.4	83.2	108.2	164.2	160.3	25	WS355520T	TKY15T	WPT4405	MK1KS	21.5	* TAWNH2150T	●	<input type="checkbox"/>	
															TAWKH2150TG			
														21.6	TAWNH2160T	<input type="checkbox"/>	<input type="checkbox"/>	
	5	TAWMN2200S25	●	111.4	128.2	148.2	204.2	200.3	25	WS355520T	TKY15T	WPT4405	MK1KS		TAWKH2160TG			
														21.7	TAWNH2170T	<input type="checkbox"/>	<input type="checkbox"/>	
															TAWKH2170TG			
														21.8	TAWNH2180T	<input type="checkbox"/>	<input type="checkbox"/>	
															TAWKH2180TG			
														21.9	TAWNH2190T	<input type="checkbox"/>	<input type="checkbox"/>	
		TAWKH2190TG																
	8	TAWLN2200S25	●	175.9	189.9	213.9	269.9	266.0	25	WS355520T	TKY15T	WPT4405	MK1KS	22.0	TAWNH2200T	●	<input type="checkbox"/>	
															TAWKH2200TG			
22.1														TAWNH2210T	<input type="checkbox"/>	<input type="checkbox"/>		
														TAWKH2210TG				
22.2														TAWNH2220T	<input type="checkbox"/>	<input type="checkbox"/>		
														TAWKH2220TG				
22.3	TAWLN2200S25	●	175.9	189.9	213.9	269.9	266.0	25	WS355520T	TKY15T	WPT4405	MK1KS		TAWKH2230TG				
													22.3	TAWNH2230T	<input type="checkbox"/>	<input type="checkbox"/>		
														TAWKH2230TG				
													22.4	TAWNH2240T	<input type="checkbox"/>	<input type="checkbox"/>		
														TAWKH2240TG				
22.5 - 23.4	3	TAWSN2300S25	●	71.6	86.4	108.4	164.4	160.3	25	WS355521T	TKY15T	WPT4405	MK1KS	22.5	* TAWNH2250T	●	<input type="checkbox"/>	
															TAWKH2250TG			
														22.6	TAWNH2260T	<input type="checkbox"/>	<input type="checkbox"/>	
	5	TAWMN2300S25	●	116.6	133.4	158.4	214.4	210.3	25	WS355521T	TKY15T	WPT4405	MK1KS		TAWKH2260TG			
														22.7	TAWNH2270T	<input type="checkbox"/>	<input type="checkbox"/>	
															TAWKH2270TG			
														22.8	TAWNH2280T	<input type="checkbox"/>	<input type="checkbox"/>	
															TAWKH2280TG			
														22.9	TAWNH2290T	<input type="checkbox"/>	<input type="checkbox"/>	
		TAWKH2290TG																
	8	TAWLN2300S25	●	184.1	198.1	227.1	283.1	279.0	25	WS355521T	TKY15T	WPT4405	MK1KS	23.0	TAWNH2300T	●	<input type="checkbox"/>	
															TAWKH2300TG			
23.1														TAWNH2310T	<input type="checkbox"/>	<input type="checkbox"/>		
														TAWKH2310TG				
23.2														TAWNH2320T	<input type="checkbox"/>	<input type="checkbox"/>		
														TAWKH2320TG				
23.3	TAWNH2330T	<input type="checkbox"/>	<input type="checkbox"/>															
	TAWKH2330TG																	
23.4	TAWNH2340T	<input type="checkbox"/>	<input type="checkbox"/>															
	TAWKH2340TG																	

WSP BESCHREIBUNG > M153  
 SCHNITTBEDINGUNGEN > M155  
 EINSATZ HINWEISE > M156





ERSATZTEILE > N001  
 TECHNISCHE DATEN > P001

# BOHREN (SCHNEIDKRONEN AUSFÜHRUNG)

HARTMETALL

# TAW

M  
BOHREN

DC (mm)	Bohrtiefe (L/D)	Halter		Abmessungen (mm)											Schneidkrone			
		Bestellnummer	Lager	LU	LBX	LH	OAL	LF	DCONIMS	DC (mm)					Bestellnummer	Lager		
															VP15TF	VP10H		
23.5 - 24.4	3	TAWSN2400S32	●	74.8	90.6	114.6	174.6	170.3	32	WS355521T	TKY15T	WPT4405	MK1KS	23.5	* TAWNH2350T	●	<input type="checkbox"/>	
															TAWKH2350TG			
														23.6	TAWNH2360T	<input type="checkbox"/>	<input type="checkbox"/>	
	5	TAWMN2400S32	●	121.8	139.6	164.6	224.6	220.3	32	WS355521T	TKY15T	WPT4405	MK1KS	23.7	TAWNH2370T	<input type="checkbox"/>	<input type="checkbox"/>	
															TAWKH2370TG			
														23.8	TAWNH2380T	<input type="checkbox"/>	<input type="checkbox"/>	
	8	TAWLN2400S32	●	192.3	206.6	236.6	296.6	292.3	32	WS355521T	TKY15T	WPT4405	MK1KS	23.9	TAWNH2390T	<input type="checkbox"/>	<input type="checkbox"/>	
															TAWKH2390TG			
														24.0	TAWNH2400T	●	<input type="checkbox"/>	
	24.5 - 25.4	3	TAWSN2500S32	●	78.0	93.1	115.1	175.1	170.6	32	WS406023T	TKY25T	WPT4405	MK1KS	24.1	TAWNH2410T	<input type="checkbox"/>	<input type="checkbox"/>
																TAWKH2410TG		
															24.2	TAWNH2420T	<input type="checkbox"/>	<input type="checkbox"/>
5		TAWMN2500S32	●	127.0	145.1	170.1	230.1	225.6	32	WS406023T	TKY25T	WPT4405	MK1KS	24.3	TAWNH2430T	<input type="checkbox"/>	<input type="checkbox"/>	
															TAWKH2430TG			
														24.4	TAWNH2440T	<input type="checkbox"/>	<input type="checkbox"/>	
25.5 - 26.4	3	TAWSN2600S32	●	81.1	97.2	120.2	180.2	175.6	32	WS406024T	TKY25T	WPT4405	MK1KS	24.5	* TAWNH2450T	●	<input type="checkbox"/>	
															TAWKH2450TG			
														24.6	TAWNH2460T	<input type="checkbox"/>	<input type="checkbox"/>	
	5	TAWMN2600S32	●	132.1	151.2	175.2	235.2	230.6	32	WS406024T	TKY25T	WPT4405	MK1KS	24.7	TAWNH2470T	<input type="checkbox"/>	<input type="checkbox"/>	
															TAWKH2470TG			
														24.8	TAWNH2480T	<input type="checkbox"/>	<input type="checkbox"/>	
25.5 - 26.4	3	TAWSN2600S32	●	200.5	215.1	245.1	305.1	300.6	32	WS406023T	TKY25T	WPT4405	MK1KS	24.9	TAWNH2490T	<input type="checkbox"/>	<input type="checkbox"/>	
															TAWKH2490TG			
														25.0	TAWNH2500T	●	<input type="checkbox"/>	
	5	TAWMN2600S32	●	208.6	223.2	253.2	313.2	308.6	32	WS406024T	TKY25T	WPT4405	MK1KS	25.1	TAWNH2510T	<input type="checkbox"/>	<input type="checkbox"/>	
															TAWKH2510TG			
														25.2	TAWNH2520T	<input type="checkbox"/>	<input type="checkbox"/>	
25.5 - 26.4	3	TAWSN2600S32	●	259.0	274.1	309.1	379.1	374.6	32	WS406023T	TKY25T	WPT4405	MK1KS	25.3	TAWNH2530T	<input type="checkbox"/>	<input type="checkbox"/>	
															TAWKH2530TG			
														25.4	TAWNH2540T	<input type="checkbox"/>	<input type="checkbox"/>	
	5	TAWMN2600S32	●	259.0	274.1	309.1	379.1	374.6	32	WS406024T	TKY25T	WPT4405	MK1KS	25.5	* TAWNH2550T	●	<input type="checkbox"/>	
															TAWKH2550TG			
														25.6	TAWNH2560T	<input type="checkbox"/>	<input type="checkbox"/>	
25.5 - 26.4	3	TAWSN2600S32	●	259.0	274.1	309.1	379.1	374.6	32	WS406024T	TKY25T	WPT4405	MK1KS	25.7	TAWNH2570T	<input type="checkbox"/>	<input type="checkbox"/>	
															TAWKH2570TG			
														25.8	TAWNH2580T	<input type="checkbox"/>	<input type="checkbox"/>	
	5	TAWMN2600S32	●	259.0	274.1	309.1	379.1	374.6	32	WS406024T	TKY25T	WPT4405	MK1KS	25.9	TAWNH2590T	<input type="checkbox"/>	<input type="checkbox"/>	
															TAWKH2590TG			
														26.0	TAWNH2600T	●	<input type="checkbox"/>	
25.5 - 26.4	3	TAWSN2600S32	●	259.0	274.1	309.1	379.1	374.6	32	WS406024T	TKY25T	WPT4405	MK1KS	26.1	TAWNH2610T	<input type="checkbox"/>	<input type="checkbox"/>	
															TAWKH2610TG			
														26.2	TAWNH2620T	<input type="checkbox"/>	<input type="checkbox"/>	
	5	TAWMN2600S32	●	259.0	274.1	309.1	379.1	374.6	32	WS406024T	TKY25T	WPT4405	MK1KS	26.3	TAWNH2630T	<input type="checkbox"/>	<input type="checkbox"/>	
															TAWKH2630TG			
														26.4	TAWNH2640T	<input type="checkbox"/>	<input type="checkbox"/>	

Hinweis 1) Die obigen Abmessungen (\*) beziehen sich für montierte Schneidkronen auf Grundkörpern.

Hinweis 2) Bei Bedarf von abweichenden Geometrien setzen Sie sich mit uns in Verbindung.

(Andere Durchmesser und Längen können bestellt werden).

● : Lagerstandard. □ : Herstellung nur auf Anfrage  
(Verpackungseinheit: 1Stk.)

M150

DC (mm)	Bohrtiefe (L/D)	Halter		Abmessungen (mm)						Spannschraube	Schlüssel	Schlitz- Reiniger	Kupfer- paste	Schneidkrone				
		Bestellnummer	Lager	LU	LBX	LH	OAL	LF	DCONIMS					DC (mm)	Bestellnummer	Lager		
																VP15TF	VP10H	
26.5 - 27.4	3	TAWSN2700S32	●	84.3	99.4	120.4	180.4	175.6	32	WS406024T	TKY25T	WPT4405	MK1KS	26.5	* TAWNH2650T	●	<input type="checkbox"/>	
															TAWKH2650TG			
														26.6	TAWNH2660T	<input type="checkbox"/>	<input type="checkbox"/>	
															TAWKH2660TG			
		5	TAWMN2700S32	●	137.3	156.4	180.4	240.4	235.6	32	WS406024T	TKY25T	WPT4405	MK1KS	26.7	TAWNH2670T	<input type="checkbox"/>	<input type="checkbox"/>
															TAWKH2670TG			
	26.8														TAWNH2680T	<input type="checkbox"/>	<input type="checkbox"/>	
															TAWKH2680TG			
		8	TAWLN2700S32	●	216.8	231.4	261.4	321.4	316.6	32	WS406024T	TKY25T	WPT4405	MK1KS	26.9	TAWNH2690T	<input type="checkbox"/>	<input type="checkbox"/>
															TAWKH2690TG			
	27.0														TAWNH2700T	●	<input type="checkbox"/>	
															TAWKH2700TG			
														27.1	TAWNH2710T	<input type="checkbox"/>	<input type="checkbox"/>	
														TAWKH2710TG				
27.2														TAWNH2720T	<input type="checkbox"/>	<input type="checkbox"/>		
														TAWKH2720TG				
														27.3	TAWNH2730T	<input type="checkbox"/>	<input type="checkbox"/>	
														TAWKH2730TG				
27.4														TAWNH2740T	<input type="checkbox"/>	<input type="checkbox"/>		
														TAWKH2740TG				
27.5 - 28.4	3	TAWSN2800S32	●	87.5	102.2	125.2	185.2	180.2	32	WS508026T	TKY27T	WPT4405	MK1KS	27.5	* TAWNH2750T	●	<input type="checkbox"/>	
															TAWKH2750TG			
														27.6	TAWNH2760T	<input type="checkbox"/>	<input type="checkbox"/>	
															TAWKH2760TG			
		5	TAWMN2800S32	●	142.5	162.2	185.2	245.2	240.2	32	WS508026T	TKY27T	WPT4405	MK1KS	27.7	TAWNH2770T	<input type="checkbox"/>	<input type="checkbox"/>
															TAWKH2770TG			
	27.8														TAWNH2780T	<input type="checkbox"/>	<input type="checkbox"/>	
															TAWKH2780TG			
		8	TAWLN2800S32	●	225.0	239.2	269.2	329.2	324.2	32	WS508026T	TKY27T	WPT4405	MK1KS	27.9	TAWNH2790T	<input type="checkbox"/>	<input type="checkbox"/>
															TAWKH2790TG			
	28.0														TAWNH2800T	●	<input type="checkbox"/>	
															TAWKH2800TG			
														28.1	TAWNH2810T	<input type="checkbox"/>	<input type="checkbox"/>	
														TAWKH2810TG				
28.2														TAWNH2820T	<input type="checkbox"/>	<input type="checkbox"/>		
														TAWKH2820TG				
														28.3	TAWNH2830T	<input type="checkbox"/>	<input type="checkbox"/>	
														TAWKH2830TG				
28.4														TAWNH2840T	<input type="checkbox"/>	<input type="checkbox"/>		
														TAWKH2840TG				
28.5 - 29.4	3	TAWSN2900S32	●	90.7	105.4	130.4	190.4	185.2	32	WS508027T	TKY27T	WPT4405	MK1KS	28.5	* TAWNH2850T	●	<input type="checkbox"/>	
															TAWKH2850TG			
														28.6	TAWNH2860T	<input type="checkbox"/>	<input type="checkbox"/>	
															TAWKH2860TG			
		5	TAWMN2900S32	●	147.7	167.4	190.4	250.4	245.2	32	WS508027T	TKY27T	WPT4405	MK1KS	28.7	TAWNH2870T	<input type="checkbox"/>	<input type="checkbox"/>
															TAWKH2870TG			
	28.8														TAWNH2880T	<input type="checkbox"/>	<input type="checkbox"/>	
															TAWKH2880TG			
		8	TAWLN2900S32	●	233.2	247.4	277.4	337.4	332.2	32	WS508027T	TKY27T	WPT4405	MK1KS	28.9	TAWNH2890T	<input type="checkbox"/>	<input type="checkbox"/>
															TAWKH2890TG			
	29.0														TAWNH2900T	●	<input type="checkbox"/>	
															TAWKH2900TG			
														29.1	TAWNH2910T	<input type="checkbox"/>	<input type="checkbox"/>	
														TAWKH2910TG				
29.2														TAWNH2920T	<input type="checkbox"/>	<input type="checkbox"/>		
														TAWKH2920TG				
														29.3	TAWNH2930T	<input type="checkbox"/>	<input type="checkbox"/>	
														TAWKH2930TG				
29.4														TAWNH2940T	<input type="checkbox"/>	<input type="checkbox"/>		
														TAWKH2940TG				

WSP BESCHREIBUNG > M153  
 SCHNITTBEDINGUNGEN > M155  
 EINSATZ HINWEISE > M156

ERSATZTEILE > N001  
 TECHNISCHE DATEN > P001





# BOHREN (SCHNEIDKRONEN AUSFÜHRUNG)

HARTMETALL

# TAW

M

BOHREN

DC (mm)	Bohrtiefe (L/D)	Halter		Abmessungen (mm)						DCONIMS					Schneidkrone			
		Bestellnummer	Lager	LU	LBX	LH	OAL	LF	DC						Bestellnummer	Lager		
																	VP15TF	VP10H
29.5 - 30.4	3	TAWSN3000S32	●	93.9	109.6	130.6	190.6	185.2	32	WS508027T	TKY27T	WPT4405	MK1KS	29.5	* TAWNH2950T	●	<input type="checkbox"/>	
															TAWKH2950TG			
														29.6	TAWNH2960T	<input type="checkbox"/>	<input type="checkbox"/>	
			TAWKH2960TG															
			TAWNH2970T	<input type="checkbox"/>	<input type="checkbox"/>													
			TAWKH2970TG															
			TAWNH2980T	<input type="checkbox"/>	<input type="checkbox"/>													
			TAWKH2980TG															
			TAWNH2990T	<input type="checkbox"/>	<input type="checkbox"/>													
			TAWKH2990TG															
			TAWNH3000T	●	<input type="checkbox"/>													
			TAWKH3000TG															
		TAWNH3010T	<input type="checkbox"/>	<input type="checkbox"/>														
		TAWKH3010TG																
		TAWNH3020T	<input type="checkbox"/>	<input type="checkbox"/>														
		TAWKH3020TG																
		TAWNH3030T	<input type="checkbox"/>	<input type="checkbox"/>														
		TAWKH3030TG																
		TAWNH3040T	<input type="checkbox"/>	<input type="checkbox"/>														
		TAWKH3040TG																

Hinweis 1) Die obigen Abmessungen (\*) beziehen für montierte Schneidkronen auf Grundkörpern.

Hinweis 2) Bei Bedarf von abweichenden Geometrien setzen Sie sich mit uns in Verbindung.

(Andere Durchmesser und Längen können bestellt werden).

● : Lagerstandard. □ : Herstellung nur auf Anfrage  
(Verpackungseinheit: 1Stk.)

## Schneidkrone Typ H

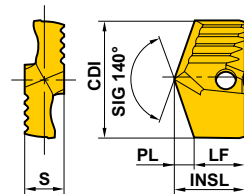

Bestellnummer	Lager		Abmessungen (mm)					Halter für Schneidkrone
	VP15TF	VP10H	CDI	INSL	LF	PL	S	
TAWNH1850T	●	□	18.5	12.7	9.3	3.4	7.0	TAWSN 1900S25
TAWNH1860T	●	□	18.6	12.7	9.3	3.4	7.0	
TAWNH1870T	●	□	18.7	12.7	9.3	3.4	7.0	
TAWNH1880T	●	□	18.8	12.7	9.3	3.4	7.0	
TAWNH1890T	●	□	18.9	12.7	9.3	3.4	7.0	
TAWNH1900T	●	□	19.0	12.7	9.2	3.5	7.0	
TAWNH1910T	●	□	19.1	12.7	9.2	3.5	7.0	
TAWNH1920T	●	□	19.2	12.7	9.2	3.5	7.0	
TAWNH1930T	●	□	19.3	12.7	9.2	3.5	7.0	
TAWNH1940T	●	□	19.4	12.7	9.2	3.5	7.0	
TAWNH1950T	●	□	19.5	12.6	9.1	3.5	7.0	TAWSN 2000S25
TAWNH1960T	●	□	19.6	12.7	9.1	3.6	7.0	
TAWNH1970T	●	□	19.7	12.7	9.1	3.6	7.0	
TAWNH1980T	●	□	19.8	12.7	9.1	3.6	7.0	
TAWNH1990T	●	□	19.9	12.7	9.1	3.6	7.0	
TAWNH2000T	●	□	20.0	12.6	9.0	3.6	7.0	
TAWNH2010T	□	□	20.1	12.7	9.0	3.7	7.0	
TAWNH2020T	□	□	20.2	12.7	9.0	3.7	7.0	
TAWNH2030T	□	□	20.3	12.7	9.0	3.7	7.0	
TAWNH2040T	□	□	20.4	12.7	9.0	3.7	7.0	
TAWNH2050T	●	□	20.5	12.6	8.9	3.7	7.0	TAWSN 2100S25
TAWNH2060T	□	□	20.6	12.6	8.9	3.7	7.0	
TAWNH2070T	□	□	20.7	12.7	8.9	3.8	7.0	
TAWNH2080T	□	□	20.8	12.7	8.9	3.8	7.0	
TAWNH2090T	□	□	20.9	12.7	8.9	3.8	7.0	
TAWNH2100T	●	□	21.0	12.6	8.8	3.8	7.0	
TAWNH2110T	□	□	21.1	12.6	8.8	3.8	7.0	
TAWNH2120T	□	□	21.2	12.7	8.8	3.9	7.0	
TAWNH2130T	□	□	21.3	12.7	8.8	3.9	7.0	
TAWNH2140T	□	□	21.4	12.7	8.8	3.9	7.0	
TAWNH2150T	●	□	21.5	14.5	10.6	3.9	8.0	TAWSN 2200S25
TAWNH2160T	□	□	21.6	14.5	10.6	3.9	8.0	
TAWNH2170T	□	□	21.7	14.5	10.6	3.9	8.0	
TAWNH2180T	□	□	21.8	14.6	10.6	4.0	8.0	
TAWNH2190T	□	□	21.9	14.6	10.6	4.0	8.0	
TAWNH2200T	●	□	22.0	14.5	10.5	4.0	8.0	
TAWNH2210T	□	□	22.1	14.5	10.5	4.0	8.0	
TAWNH2220T	□	□	22.2	14.5	10.5	4.0	8.0	
TAWNH2230T	□	□	22.3	14.6	10.5	4.1	8.0	
TAWNH2240T	□	□	22.4	14.6	10.5	4.1	8.0	

Bestellnummer	Lager		Abmessungen (mm)					Halter für Schneidkrone
	VP15TF	VP10H	CDI	INSL	LF	PL	S	
TAWNH2250T	●	□	22.5	14.5	10.4	4.1	8.0	TAWSN 2300S25
TAWNH2260T	□	□	22.6	14.5	10.4	4.1	8.0	
TAWNH2270T	□	□	22.7	14.5	10.4	4.1	8.0	
TAWNH2280T	□	□	22.8	14.5	10.4	4.1	8.0	
TAWNH2290T	□	□	22.9	14.6	10.4	4.2	8.0	
TAWNH2300T	●	□	23.0	14.5	10.3	4.2	8.0	
TAWNH2310T	□	□	23.1	14.5	10.3	4.2	8.0	
TAWNH2320T	□	□	23.2	14.5	10.3	4.2	8.0	
TAWNH2330T	□	□	23.3	14.5	10.3	4.2	8.0	
TAWNH2340T	□	□	23.4	14.6	10.3	4.3	8.0	
TAWNH2350T	●	□	23.5	14.5	10.2	4.3	8.0	TAWSN 2400S32
TAWNH2360T	□	□	23.6	14.5	10.2	4.3	8.0	
TAWNH2370T	□	□	23.7	14.5	10.2	4.3	8.0	
TAWNH2380T	□	□	23.8	14.5	10.2	4.3	8.0	
TAWNH2390T	□	□	23.9	14.5	10.2	4.3	8.0	
TAWNH2400T	●	□	24.0	14.5	10.1	4.4	8.0	
TAWNH2410T	□	□	24.1	14.5	10.1	4.4	8.0	
TAWNH2420T	□	□	24.2	14.5	10.1	4.4	8.0	
TAWNH2430T	□	□	24.3	14.5	10.1	4.4	8.0	
TAWNH2440T	□	□	24.4	14.5	10.1	4.4	8.0	
TAWNH2450T	●	□	24.5	16.2	11.7	4.5	9.0	TAWSN 2500S32
TAWNH2460T	□	□	24.6	16.2	11.7	4.5	9.0	
TAWNH2470T	□	□	24.7	16.2	11.7	4.5	9.0	
TAWNH2480T	□	□	24.8	16.2	11.7	4.5	9.0	
TAWNH2490T	□	□	24.9	16.2	11.7	4.5	9.0	
TAWNH2500T	●	□	25.0	16.1	11.6	4.5	9.0	
TAWNH2510T	□	□	25.1	16.2	11.6	4.6	9.0	
TAWNH2520T	□	□	25.2	16.2	11.6	4.6	9.0	
TAWNH2530T	□	□	25.3	16.2	11.6	4.6	9.0	
TAWNH2540T	□	□	25.4	16.2	11.6	4.6	9.0	
TAWNH2550T	●	□	25.5	16.1	11.5	4.6	9.0	TAWSN 2600S32
TAWNH2560T	□	□	25.6	16.2	11.5	4.7	9.0	
TAWNH2570T	□	□	25.7	16.2	11.5	4.7	9.0	
TAWNH2580T	□	□	25.8	16.2	11.5	4.7	9.0	
TAWNH2590T	□	□	25.9	16.2	11.5	4.7	9.0	
TAWNH2600T	●	□	26.0	16.1	11.4	4.7	9.0	
TAWNH2610T	□	□	26.1	16.1	11.4	4.7	9.0	
TAWNH2620T	□	□	26.2	16.2	11.4	4.8	9.0	
TAWNH2630T	□	□	26.3	16.2	11.4	4.8	9.0	
TAWNH2640T	□	□	26.4	16.2	11.4	4.8	9.0	

M

BOHREN

# BOHREN (SCHNEIDKRONEN AUSFÜHRUNG)

HARTMETALL

# TAW

BOHREN

M

Bestellnummer	Lager		Abmessungen (mm)					Halter für Schneidkrone
	VP15TF	VP10H	CDI	INSL	LF	PL	S	
TAWNH2650T	●	□	26.5	16.1	11.3	4.8	9.0	TAWSN 2700S32
TAWNH2660T	□	□	26.6	16.1	11.3	4.8	9.0	
TAWNH2670T	□	□	26.7	16.2	11.3	4.9	9.0	
TAWNH2680T	□	□	26.8	16.2	11.3	4.9	9.0	
TAWNH2690T	□	□	26.9	16.2	11.3	4.9	9.0	
TAWNH2700T	●	□	27.0	16.1	11.2	4.9	9.0	
TAWNH2710T	□	□	27.1	16.1	11.2	4.9	9.0	
TAWNH2720T	□	□	27.2	16.1	11.2	4.9	9.0	
TAWNH2730T	□	□	27.3	16.2	11.2	5.0	9.0	
TAWNH2740T	□	□	27.4	16.2	11.2	5.0	9.0	
TAWNH2750T	●	□	27.5	17.3	12.3	5.0	10.0	TAWSN 2800S32
TAWNH2760T	□	□	27.6	17.3	12.3	5.0	10.0	
TAWNH2770T	□	□	27.7	17.3	12.3	5.0	10.0	
TAWNH2780T	□	□	27.8	17.4	12.3	5.1	10.0	
TAWNH2790T	□	□	27.9	17.4	12.3	5.1	10.0	
TAWNH2800T	●	□	28.0	17.3	12.2	5.1	10.0	
TAWNH2810T	□	□	28.1	17.3	12.2	5.1	10.0	
TAWNH2820T	□	□	28.2	17.3	12.2	5.1	10.0	
TAWNH2830T	□	□	28.3	17.4	12.2	5.2	10.0	
TAWNH2840T	□	□	28.4	17.4	12.2	5.2	10.0	

Bestellnummer	Lager		Abmessungen (mm)					Halter für Schneidkrone
	VP15TF	VP10H	CDI	INSL	LF	PL	S	
TAWNH2850T	●	□	28.5	17.3	12.1	5.2	10.0	TAWSN 2900S32
TAWNH2860T	□	□	28.6	17.3	12.1	5.2	10.0	
TAWNH2870T	□	□	28.7	17.3	12.1	5.2	10.0	
TAWNH2880T	□	□	28.8	17.3	12.1	5.2	10.0	
TAWNH2890T	□	□	28.9	17.4	12.1	5.3	10.0	
TAWNH2900T	●	□	29.0	17.3	12.0	5.3	10.0	
TAWNH2910T	□	□	29.1	17.3	12.0	5.3	10.0	
TAWNH2920T	□	□	29.2	17.3	12.0	5.3	10.0	
TAWNH2930T	□	□	29.3	17.3	12.0	5.3	10.0	
TAWNH2940T	□	□	29.4	17.4	12.0	5.4	10.0	
TAWNH2950T	●	□	29.5	17.3	11.9	5.4	10.0	TAWSN 3000S32
TAWNH2960T	□	□	29.6	17.3	11.9	5.4	10.0	
TAWNH2970T	□	□	29.7	17.3	11.9	5.4	10.0	
TAWNH2980T	□	□	29.8	17.3	11.9	5.4	10.0	
TAWNH2990T	□	□	29.9	17.3	11.9	5.4	10.0	
TAWNH3000T	●	□	30.0	17.3	11.8	5.5	10.0	
TAWNH3010T	□	□	30.1	17.3	11.8	5.5	10.0	
TAWNH3020T	□	□	30.2	17.3	11.8	5.5	10.0	
TAWNH3030T	□	□	30.3	17.3	11.8	5.5	10.0	
TAWNH3040T	□	□	30.4	17.3	11.8	5.5	10.0	

● : Lagerstandard. □ : Herstellung nur auf Anfrage  
(Verpackungseinheit: 1Stk.)

SCHNITTBEDINGUNGEN > M155  
EINSATZ HINWEISE > M156

ERSATZTEILE > N001  
TECHNISCHE DATEN > P001



## SCHNITTDATENEMPFEHLUNGEN

Material	Bohrer Durchm. Bedingung Härte	Ø 18.5–Ø 21.4		Ø 21.5–Ø 24.4		
		Schnittgeschw. (m/min)	Vorschub (mm/U.)	Schnittgeschw. (m/min)	Vorschub (mm/U.)	
P	Allg. Baustahl	≤180HB	90 (70–110)	0.25 (0.20–0.30)	100 (80–120)	0.30 (0.25–0.35)
	C-Stahl Leg. Stahl	180–280HB	80 (60–100)	0.25 (0.20–0.30)	90 (70–110)	0.30 (0.25–0.35)
		280–350HB	70 (50–90)	0.20 (0.15–0.25)	80 (60–100)	0.25 (0.20–0.30)
M	Rostfreier Stahl	≤200HB	60 (50–70)	0.20 (0.15–0.22)	60 (50–70)	0.20 (0.15–0.22)
K	Guss	Zugfestigkeit ≤350MPa	120 (60–140)	0.25 (0.20–0.30)	130 (80–150)	0.35 (0.25–0.40)
	Duktiler Guss	Zugfestigkeit ≤450MPa	80 (60–90)	0.25 (0.20–0.30)	90 (60–100)	0.30 (0.25–0.35)

Material	Bohrer Durchm. Bedingung Härte	Ø 24.5–Ø 27.4		Ø 27.5–Ø 30.4		
		Schnittgeschw. (m/min)	Vorschub (mm/U.)	Schnittgeschw. (m/min)	Vorschub (mm/U.)	
P	Allg. Baustahl	≤180HB	110 (80–120)	0.30 (0.25–0.35)	110 (80–120)	0.30 (0.25–0.35)
	C-Stahl Leg. Stahl	180–280HB	100 (80–120)	0.30 (0.25–0.35)	100 (80–120)	0.30 (0.25–0.35)
		280–350HB	90 (70–110)	0.25 (0.20–0.30)	90 (70–110)	0.25 (0.20–0.30)
M	Rostfreier Stahl	≤200HB	70 (60–80)	0.25 (0.20–0.28)	70 (60–80)	0.25 (0.20–0.28)
K	Guss	Zugfestigkeit ≤350MPa	140 (90–160)	0.35 (0.25–0.40)	140 (90–160)	0.40 (0.30–0.45)
	Duktiler Guss	Zugfestigkeit ≤450MPa	100 (80–110)	0.30 (0.25–0.35)	100 (80–110)	0.30 (0.25–0.35)

Hinweis 1) Für das Bearbeiten von Bau- und rostfreiem Stahl empfehlen wir eine Schneidkrone mit Verfassung des Typ H.

Hinweis 2) Empfohlen für den Einsatz bei stabilen Bearbeitungsbedingungen. Verwenden Sie bitte eine interne Kühlmittelzufuhr bei Bearbeitungen von rostfreien Werkstoffen. (MMS ist nicht empfohlen)

# TAW

## FASENBREITE

Wenn eine Schneidkrone mit einer anderen Verfassung bevorzugt wird, verwenden Sie bitte folgende Symbole bei der Bestellnummer.

(Verfassungen)

Verfassung	Fasenbreite (mm)
F	0
G	0.02–0.05
H	0.05–0.10
- (Standard)	0.10–0.15
S	0.20–0.25
M	0.25–0.30

(WSP Bestellnummer)

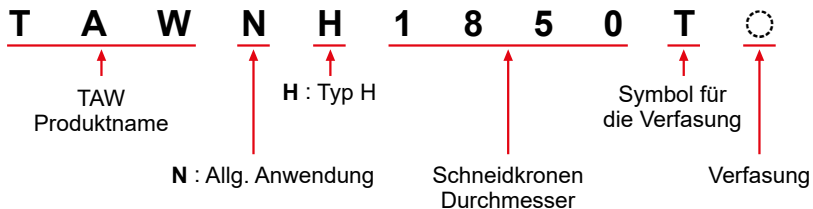

## BENUTZERHINWEIS

### SCHNEIDKRONEN-BEFESTIGUNG

- Entfernen Sie die Klemmschraube zum Installieren der Schneidkrone. (H Ausführung)
- Positionieren Sie die Schneidkrone an die Führungsrillen und schieben die Schneidkrone bis zum Anschlag ein.
- Spannen Sie die Klemmschraube bei gleichzeitigem Festhalten mit den Fingern. (Bild 1)
- Die Schneidkrone muss am Grund anliegen. (Bild 2)

Spannschraube mit Drehmoment gemäß nachfolgender Tabelle festziehen.

Bohrer Durchm.	Dreh-moment
Ø14–Ø15	2.0N•m
Ø16–Ø18	2.0N•m
Ø19–Ø21	3.5N•m
Ø22–Ø24	5.5N•m
Ø25–Ø27	8.5N•m
Ø28–Ø30	12.0N•m



Bild 1



OK

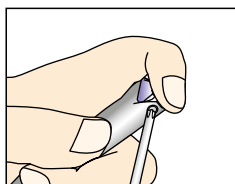
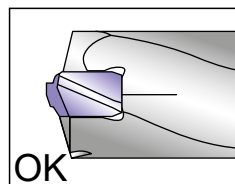
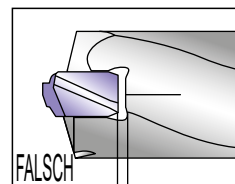

FALSCH

Schneidkrone liegt nicht an

## AUSTAUSCHEN DER WSP

- Bevor Sie die neue Schneidkrone einbauen, bitte den Schneidkronensitz sorgfältig reinigen und den Schlitz mit dem beiliegenden Schlitzreiniger säubern.

# Notizen

---

A series of horizontal dashed lines for writing notes.

# BOHREN (WSP AUSFÜHRUNG)

# MVX

- Ideale Kombination von äußerer WSP mit CVD-Beschichtung und innerer WSP mit PVD-Beschichtung.
- Hochstabiler Werkzeugkörper für die Tieflochbohrung bis L/D=6.



P

M

K

N

S

H

M

BOHREN

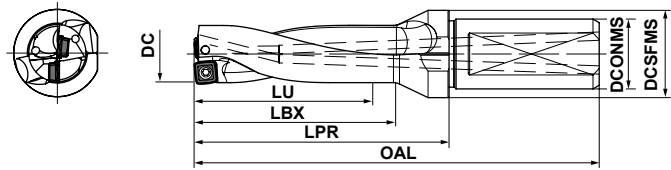

Maximaler Versatz für die Drehbearbeitung

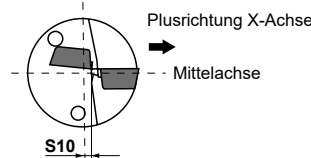

L/D	Bearbeitungstoleranz (Leitlinien) (mm)		
	Ø14.0 – Ø33.0	Ø33.5 – Ø47.0	Ø48.0 – Ø63.0
2D, 3D	0 + 0.25	0 + 0.3	0 + 0.3
4D, 5D	0 + 0.35	0 + 0.4	0 + 0.45
6D	0 + 0.45	0 + 0.6	

DC (mm)	Bohrtiefe (L/D)	Bestellnummer	Lager	Zähne	Abmessungen (mm)						S10 (mm)	WSP	Klemmschraube	F Schlüssel
					LU	LBX	LPR	OAL	DCONMS	DCSFMS				
14.0	2	MVX1400X2F20	●	2	28	35	50	93	20	25	0.6	SOX05	TPS20-1	TIP06F
	3	MVX1400X3F20	●	2	42	49	64	107	20	25	0.6	SOX05	TPS20-1	TIP06F
	4	MVX1400X4F20	●	2	56	63	78	121	20	25	0.6	SOX05	TPS20-1	TIP06F
	5	MVX1400X5F20	●	2	70	77	92	135	20	25	0.6	SOX05	TPS20-1	TIP06F
14.5	2	MVX1450X2F20	●	2	29	36	51	94	20	25	0.5	SOX05	TPS20-1	TIP06F
	3	MVX1450X3F20	●	2	43.5	50.5	65.5	108.5	20	25	0.5	SOX05	TPS20-1	TIP06F
	4	MVX1450X4F20	●	2	58	65	80	123	20	25	0.5	SOX05	TPS20-1	TIP06F
	5	MVX1450X5F20	●	2	72.5	79.5	94.5	137.5	20	25	0.5	SOX05	TPS20-1	TIP06F
15.0	2	MVX1500X2F20	●	2	30	37	52	95	20	25	0.35	SOX05	TPS20-1	TIP06F
	3	MVX1500X3F20	●	2	45	52	67	110	20	25	0.35	SOX05	TPS20-1	TIP06F
	4	MVX1500X4F20	●	2	60	67	82	125	20	25	0.35	SOX05	TPS20-1	TIP06F
	5	MVX1500X5F20	●	2	75	82	97	140	20	25	0.35	SOX05	TPS20-1	TIP06F
15.5	2	MVX1550X2F20	●	2	31	38	53	96	20	25	0.3	SOX05	TPS20-1	TIP06F
	3	MVX1550X3F20	●	2	46.5	53.5	68.5	111.5	20	25	0.3	SOX05	TPS20-1	TIP06F
	4	MVX1550X4F20	●	2	62	69	84	127	20	25	0.3	SOX05	TPS20-1	TIP06F
	5	MVX1550X5F20	●	2	77.5	84.5	99.5	142.5	20	25	0.3	SOX05	TPS20-1	TIP06F
16.0	2	MVX1600X2F20	●	2	32	39	54	97	20	25	0.25	SOX05	TPS20-1	TIP06F
	3	MVX1600X3F20	●	2	48	55	70	113	20	25	0.25	SOX05	TPS20-1	TIP06F
	4	MVX1600X4F20	●	2	64	71	86	129	20	25	0.25	SOX05	TPS20-1	TIP06F
	5	MVX1600X5F20	●	2	80	87	102	145	20	25	0.25	SOX05	TPS20-1	TIP06F
16.5	2	MVX1650X2F20	●	2	33	40	55	98	20	25	0.25	SOX05	TPS20-1	TIP06F
	3	MVX1650X3F20	●	2	49.5	56.5	71.5	114.5	20	25	0.25	SOX05	TPS20-1	TIP06F
	4	MVX1650X4F20	●	2	66	73	88	131	20	25	0.25	SOX05	TPS20-1	TIP06F
	5	MVX1650X5F20	●	2	82.5	89.5	104.5	147.5	20	25	0.25	SOX05	TPS20-1	TIP06F
17.0	2	MVX1700X2F20	●	2	34	41	56	99	20	25	0.5	SOX06	TPS25	TIP07F
	3	MVX1700X3F20	●	2	51	58	73	116	20	25	0.5	SOX06	TPS25	TIP07F
	4	MVX1700X4F20	●	2	68	75	90	133	20	25	0.5	SOX06	TPS25	TIP07F
	5	MVX1700X5F20	●	2	85	92	107	150	20	25	0.5	SOX06	TPS25	TIP07F
	6	MVX1700X6F20	●	2	102	109	124	167	20	25	0.5	SOX06	TPS25	TIP07F

\* Spannmoment (N • m) : TPS20-1=0.6, TPS25=1.0

● : Lagerstandard.

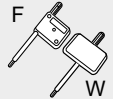
DC (mm)	Bohrtiefe (L/D)	Bestellnummer	Lager	Zähne	Abmessungen (mm)						S10 (mm)	WSP		
					LU	LBX	LPR	OAL	DCONMS	DCSFMS				
					Klemmschraube	Schlüssel								
17.5	2	MVX1750X2F25	●	2	35	42	62	112	25	32	0.45	SOX06	TPS25	TIP07F
	3	MVX1750X3F25	●	2	52.5	59.5	79.5	129.5	25	32	0.45	SOX06	TPS25	TIP07F
	4	MVX1750X4F25	●	2	70	77	97	147	25	32	0.45	SOX06	TPS25	TIP07F
	5	MVX1750X5F25	●	2	87.5	94.5	114.5	164.5	25	32	0.45	SOX06	TPS25	TIP07F
	6	MVX1750X6F25	●	2	105	112	132	182	25	32	0.45	SOX06	TPS25	TIP07F
18.0	2	MVX1800X2F25	●	2	36	43	63	113	25	32	0.4	SOX06	TPS25	TIP07F
	3	MVX1800X3F25	●	2	54	61	81	131	25	32	0.4	SOX06	TPS25	TIP07F
	4	MVX1800X4F25	●	2	72	79	99	149	25	32	0.4	SOX06	TPS25	TIP07F
	5	MVX1800X5F25	●	2	90	97	117	167	25	32	0.4	SOX06	TPS25	TIP07F
	6	MVX1800X6F25	●	2	108	115	135	185	25	32	0.4	SOX06	TPS25	TIP07F
18.5	2	MVX1850X2F25	●	2	37	44	64	114	25	32	0.35	SOX06	TPS25	TIP07F
	3	MVX1850X3F25	●	2	55.5	62.5	82.5	132.5	25	32	0.35	SOX06	TPS25	TIP07F
	4	MVX1850X4F25	●	2	74	81	101	151	25	32	0.35	SOX06	TPS25	TIP07F
	5	MVX1850X5F25	●	2	92.5	99.5	119.5	169.5	25	32	0.35	SOX06	TPS25	TIP07F
	6	MVX1850X6F25	●	2	111	118	138	188	25	32	0.35	SOX06	TPS25	TIP07F
19.0	2	MVX1900X2F25	●	2	38	45	65	115	25	32	0.3	SOX06	TPS25	TIP07F
	3	MVX1900X3F25	●	2	57	64	84	134	25	32	0.3	SOX06	TPS25	TIP07F
	4	MVX1900X4F25	●	2	76	83	103	153	25	32	0.3	SOX06	TPS25	TIP07F
	5	MVX1900X5F25	●	2	95	102	122	172	25	32	0.3	SOX06	TPS25	TIP07F
	6	MVX1900X6F25	●	2	114	121	141	191	25	32	0.3	SOX06	TPS25	TIP07F
19.5	2	MVX1950X2F25	●	2	39	46	66	116	25	32	0.25	SOX06	TPS25	TIP07F
	3	MVX1950X3F25	●	2	58.5	65.5	85.5	135.5	25	32	0.25	SOX06	TPS25	TIP07F
	4	MVX1950X4F25	●	2	78	85	105	155	25	32	0.25	SOX06	TPS25	TIP07F
	5	MVX1950X5F25	●	2	97.5	104.5	124.5	174.5	25	32	0.25	SOX06	TPS25	TIP07F
	6	MVX1950X6F25	●	2	117	124	144	194	25	32	0.25	SOX06	TPS25	TIP07F
20.0	2	MVX2000X2F25	●	2	40	47	67	117	25	32	0.6	SOX07	TPS3	TIP10W
	3	MVX2000X3F25	●	2	60	67	87	137	25	32	0.6	SOX07	TPS3	TIP10W
	4	MVX2000X4F25	●	2	80	87	107	157	25	32	0.6	SOX07	TPS3	TIP10W
	5	MVX2000X5F25	●	2	100	107	127	177	25	32	0.6	SOX07	TPS3	TIP10W
	6	MVX2000X6F25	●	2	120	127	147	197	25	32	0.6	SOX07	TPS3	TIP10W
20.5	2	MVX2050X2F25	●	2	41	48	68	118	25	32	0.55	SOX07	TPS3	TIP10W
	3	MVX2050X3F25	●	2	61.5	68.5	88.5	138.5	25	32	0.55	SOX07	TPS3	TIP10W
21.0	2	MVX2100X2F25	●	2	42	49	69	119	25	32	0.5	SOX07	TPS3	TIP10W
	3	MVX2100X3F25	●	2	63	70	90	140	25	32	0.5	SOX07	TPS3	TIP10W
	4	MVX2100X4F25	●	2	84	91	111	161	25	32	0.5	SOX07	TPS3	TIP10W
	5	MVX2100X5F25	●	2	105	112	132	182	25	32	0.5	SOX07	TPS3	TIP10W
	6	MVX2100X6F25	●	2	126	133	153	203	25	32	0.5	SOX07	TPS3	TIP10W
21.5	2	MVX2150X2F25	●	2	43	50	70	120	25	32	0.45	SOX07	TPS3	TIP10W
	3	MVX2150X3F25	●	2	64.5	71.5	91.5	141.5	25	32	0.45	SOX07	TPS3	TIP10W
22.0	2	MVX2200X2F25	●	2	44	51	71	121	25	32	0.4	SOX07	TPS3	TIP10W
	3	MVX2200X3F25	●	2	66	73	93	143	25	32	0.4	SOX07	TPS3	TIP10W
	4	MVX2200X4F25	●	2	88	95	115	165	25	32	0.4	SOX07	TPS3	TIP10W
	5	MVX2200X5F25	●	2	110	117	137	187	25	32	0.4	SOX07	TPS3	TIP10W
	6	MVX2200X6F25	●	2	132	139	159	209	25	32	0.4	SOX07	TPS3	TIP10W
22.5	2	MVX2250X2F25	●	2	45	52	72	122	25	32	0.35	SOX07	TPS3	TIP10W
	3	MVX2250X3F25	●	2	67.5	74.5	94.5	144.5	25	32	0.35	SOX07	TPS3	TIP10W

\* Spannmoment (N • m) : TPS25=1.0, TPS3=2.0

WSP BESCHREIBUNG > M166  
 SCHNITTBEDINGUNGEN > M167  
 VERSTELLHÜLSEN > M170



EINSATZ HINWEISE > M171  
 ERSATZTEILE > N001  
 TECHNISCHE DATEN > P001

# BOHREN (WSP AUSFÜHRUNG)

HARTMETALL



# MVX

M  
BOHREN

DC (mm)	Bohrtiefe (L/D)	Bestellnummer	Lager	Zähne	Abmessungen (mm)					S10 (mm)	WSP			
					LU	LBX	LPR	OAL	DCONMS					DCSFMS
23.0	2	MVX2300X2F25	●	2	46	53	73	123	25	32	0.8	SOX08	TPS351	TIP10W
	3	MVX2300X3F25	●	2	69	76	96	146	25	32	0.8	SOX08	TPS351	TIP10W
	4	MVX2300X4F25	●	2	92	99	119	169	25	32	0.8	SOX08	TPS351	TIP10W
	5	MVX2300X5F25	●	2	115	122	142	192	25	32	0.8	SOX08	TPS351	TIP10W
	6	MVX2300X6F25	●	2	138	145	165	215	25	32	0.8	SOX08	TPS351	TIP10W
23.5	2	MVX2350X2F25	●	2	47	54	74	124	25	32	0.75	SOX08	TPS351	TIP10W
	3	MVX2350X3F25	●	2	70.5	77.5	97.5	147.5	25	32	0.75	SOX08	TPS351	TIP10W
24.0	2	MVX2400X2F25	●	2	48	55	75	125	25	32	0.7	SOX08	TPS351	TIP10W
	3	MVX2400X3F25	●	2	72	79	99	149	25	32	0.7	SOX08	TPS351	TIP10W
	4	MVX2400X4F25	●	2	96	103	123	173	25	32	0.7	SOX08	TPS351	TIP10W
	5	MVX2400X5F25	●	2	120	127	147	197	25	32	0.7	SOX08	TPS351	TIP10W
	6	MVX2400X6F25	●	2	144	151	171	221	25	32	0.7	SOX08	TPS351	TIP10W
24.5	2	MVX2450X2F25	●	2	49	56	76	126	25	32	0.65	SOX08	TPS351	TIP10W
	3	MVX2450X3F25	●	2	73.5	80.5	100.5	150.5	25	32	0.65	SOX08	TPS351	TIP10W
25.0	2	MVX2500X2F25	●	2	50	57	77	127	25	32	0.6	SOX08	TPS351	TIP10W
	3	MVX2500X3F25	●	2	75	82	102	152	25	32	0.6	SOX08	TPS351	TIP10W
	4	MVX2500X4F25	●	2	100	107	127	177	25	32	0.6	SOX08	TPS351	TIP10W
	5	MVX2500X5F25	●	2	125	132	152	202	25	32	0.6	SOX08	TPS351	TIP10W
	6	MVX2500X6F25	●	2	150	157	177	227	25	32	0.6	SOX08	TPS351	TIP10W
25.5	2	MVX2550X2F25	●	2	51	58	78	128	25	32	0.6	SOX08	TPS351	TIP10W
	3	MVX2550X3F25	●	2	76.5	83.5	103.5	153.5	25	32	0.6	SOX08	TPS351	TIP10W
26.0	2	MVX2600X2F32	●	2	52	59	79	134	32	42	0.5	SOX08	TPS351	TIP10W
	3	MVX2600X3F32	●	2	78	85	105	160	32	42	0.5	SOX08	TPS351	TIP10W
	4	MVX2600X4F32	●	2	104	111	131	186	32	42	0.5	SOX08	TPS351	TIP10W
	5	MVX2600X5F32	●	2	130	137	157	212	32	42	0.5	SOX08	TPS351	TIP10W
	6	MVX2600X6F32	●	2	156	163	183	238	32	42	0.5	SOX08	TPS351	TIP10W
26.5	2	MVX2650X2F32	●	2	53	60	80	135	32	42	0.5	SOX08	TPS351	TIP10W
	3	MVX2650X3F32	●	2	79.5	86.5	106.5	161.5	32	42	0.5	SOX08	TPS351	TIP10W
27.0	2	MVX2700X2F32	●	2	54	61	81	136	32	42	0.45	SOX08	TPS351	TIP10W
	3	MVX2700X3F32	●	2	81	88	108	163	32	42	0.45	SOX08	TPS351	TIP10W
	4	MVX2700X4F32	●	2	108	115	135	190	32	42	0.45	SOX08	TPS351	TIP10W
	5	MVX2700X5F32	●	2	135	142	162	217	32	42	0.45	SOX08	TPS351	TIP10W
	6	MVX2700X6F32	●	2	162	169	189	244	32	42	0.45	SOX08	TPS351	TIP10W
27.5	2	MVX2750X2F32	●	2	55	62	82	137	32	42	0.4	SOX08	TPS351	TIP10W
	3	MVX2750X3F32	●	2	82.5	89.5	109.5	164.5	32	42	0.4	SOX08	TPS351	TIP10W
28.0	2	MVX2800X2F32	●	2	56	63	83	138	32	42	0.85	SOX09	TPS4	TIP15W
	3	MVX2800X3F32	●	2	84	91	111	166	32	42	0.85	SOX09	TPS4	TIP15W
	4	MVX2800X4F32	●	2	112	119	139	194	32	42	0.85	SOX09	TPS4	TIP15W
	5	MVX2800X5F32	●	2	140	147	167	222	32	42	0.85	SOX09	TPS4	TIP15W
	6	MVX2800X6F32	●	2	168	175	195	250	32	42	0.85	SOX09	TPS4	TIP15W
28.5	2	MVX2850X2F32	●	2	57	64	84	139	32	42	0.8	SOX09	TPS4	TIP15W
	3	MVX2850X3F32	●	2	85.5	92.5	112.5	167.5	32	42	0.8	SOX09	TPS4	TIP15W
29.0	2	MVX2900X2F32	●	2	58	65	85	140	32	42	0.75	SOX09	TPS4	TIP15W
	3	MVX2900X3F32	●	2	87	94	114	169	32	42	0.75	SOX09	TPS4	TIP15W
	4	MVX2900X4F32	●	2	116	123	143	198	32	42	0.75	SOX09	TPS4	TIP15W
	5	MVX2900X5F32	●	2	145	152	172	227	32	42	0.75	SOX09	TPS4	TIP15W
	6	MVX2900X6F32	●	2	174	181	201	256	32	42	0.75	SOX09	TPS4	TIP15W
29.5	2	MVX2950X2F32	●	2	59	66	86	141	32	42	0.7	SOX09	TPS4	TIP15W
	3	MVX2950X3F32	●	2	88.5	95.5	115.5	170.5	32	42	0.7	SOX09	TPS4	TIP15W

\* Spannmoment (N • m) : TPS351=2.5, TPS4=3.5

● : Lagerstandard.

DC (mm)	Bohrtiefe (L/D)	Bestellnummer	Lager	Zähne	Abmessungen (mm)						S10 (mm)	WSP		
					LU	LBX	LPR	OAL	DCONMS	DCSFMS				
					Klemmschraube	Schlüssel								
30.0	2	MVX3000X2F32	●	2	60	67	87	142	32	42	0.65	SOX09	TPS4	TIP15W
	3	MVX3000X3F32	●	2	90	97	117	172	32	42	0.65	SOX09	TPS4	TIP15W
	4	MVX3000X4F32	●	2	120	127	147	202	32	42	0.65	SOX09	TPS4	TIP15W
	5	MVX3000X5F32	●	2	150	157	177	232	32	42	0.65	SOX09	TPS4	TIP15W
	6	MVX3000X6F32	●	2	180	187	207	262	32	42	0.65	SOX09	TPS4	TIP15W
30.5	3	MVX3050X3F32	●	2	91.5	98.5	118.5	173.5	32	42	0.6	SOX09	TPS4	TIP15W
31.0	2	MVX3100X2F32	●	2	62	69	89	144	32	42	0.55	SOX09	TPS4	TIP15W
	3	MVX3100X3F32	●	2	93	100	120	175	32	42	0.55	SOX09	TPS4	TIP15W
	4	MVX3100X4F32	●	2	124	131	151	206	32	42	0.55	SOX09	TPS4	TIP15W
	2	MVX3100X2F40	●	2	62	69	89	154	40	50	0.55	SOX09	TPS4	TIP15W
	3	MVX3100X3F40	●	2	93	100	120	185	40	50	0.55	SOX09	TPS4	TIP15W
	4	MVX3100X4F40	●	2	124	131	151	216	40	50	0.55	SOX09	TPS4	TIP15W
31.5	5	MVX3100X5F40	●	2	155	162	182	247	40	50	0.55	SOX09	TPS4	TIP15W
	6	MVX3100X6F40	●	2	186	193	213	278	40	50	0.55	SOX09	TPS4	TIP15W
	3	MVX3150X3F40	●	2	94.5	101.5	121.5	186.5	40	50	0.55	SOX09	TPS4	TIP15W
32.0	2	MVX3200X2F32	●	2	64	71	91	146	32	42	0.45	SOX09	TPS4	TIP15W
	3	MVX3200X3F32	●	2	96	103	123	178	32	42	0.45	SOX09	TPS4	TIP15W
	4	MVX3200X4F32	●	2	128	135	155	210	32	42	0.45	SOX09	TPS4	TIP15W
	2	MVX3200X2F40	●	2	64	71	91	156	40	50	0.45	SOX09	TPS4	TIP15W
	3	MVX3200X3F40	●	2	96	103	123	188	40	50	0.45	SOX09	TPS4	TIP15W
	4	MVX3200X4F40	●	2	128	135	155	220	40	50	0.45	SOX09	TPS4	TIP15W
32.5	5	MVX3200X5F40	●	2	160	167	187	252	40	50	0.45	SOX09	TPS4	TIP15W
	6	MVX3200X6F40	●	2	192	199	219	284	40	50	0.45	SOX09	TPS4	TIP15W
	3	MVX3250X3F40	●	2	97.5	104.5	124.5	189.5	40	50	0.45	SOX09	TPS4	TIP15W
33.0	2	MVX3300X2F32	●	2	66	73	93	148	32	42	0.4	SOX09	TPS4	TIP15W
	3	MVX3300X3F32	●	2	99	106	126	181	32	42	0.4	SOX09	TPS4	TIP15W
	4	MVX3300X4F32	●	2	132	139	159	214	32	42	0.4	SOX09	TPS4	TIP15W
	2	MVX3300X2F40	●	2	66	73	93	158	40	50	0.4	SOX09	TPS4	TIP15W
	3	MVX3300X3F40	●	2	99	106	126	191	40	50	0.4	SOX09	TPS4	TIP15W
	4	MVX3300X4F40	●	2	132	139	159	224	40	50	0.4	SOX09	TPS4	TIP15W
33.5	5	MVX3300X5F40	●	2	165	172	192	257	40	50	0.4	SOX09	TPS4	TIP15W
	6	MVX3300X6F40	●	2	198	205	225	290	40	50	0.4	SOX09	TPS4	TIP15W
	3	MVX3350X3F40	●	2	100.5	107.5	127.5	192.5	40	50	1.15	SOX11	TPS43	TIP15W
34.0	2	MVX3400X2F40	●	2	68	75	105	170	40	50	1.11	SOX11	TPS43	TIP15W
	3	MVX3400X3F40	●	2	102	109	139	204	40	50	1.11	SOX11	TPS43	TIP15W
	4	MVX3400X4F40	●	2	136	143	173	238	40	50	1.11	SOX11	TPS43	TIP15W
	5	MVX3400X5F40	●	2	170	177	207	272	40	50	1.11	SOX11	TPS43	TIP15W
	6	MVX3400X6F40	●	2	204	211	241	306	40	50	1.1	SOX11	TPS43	TIP15W
34.5	3	MVX3450X3F40	●	2	103.5	110.5	140.5	205.5	40	50	1.08	SOX11	TPS43	TIP15W
35.0	2	MVX3500X2F40	●	2	70	77	107	172	40	50	1.03	SOX11	TPS43	TIP15W
	3	MVX3500X3F40	●	2	105	112	142	207	40	50	1.03	SOX11	TPS43	TIP15W
	4	MVX3500X4F40	●	2	140	147	177	242	40	50	1.03	SOX11	TPS43	TIP15W
	5	MVX3500X5F40	●	2	175	182	212	277	40	50	1.03	SOX11	TPS43	TIP15W
	6	MVX3500X6F40	●	2	210	217	247	312	40	50	1.02	SOX11	TPS43	TIP15W
35.5	3	MVX3550X3F40	●	2	106.5	113.5	143.5	208.5	40	50	0.99	SOX11	TPS43	TIP15W
36.0	2	MVX3600X2F40	●	2	72	79	109	174	40	50	0.95	SOX11	TPS43	TIP15W
	3	MVX3600X3F40	●	2	108	115	145	210	40	50	0.95	SOX11	TPS43	TIP15W
	4	MVX3600X4F40	●	2	144	151	181	246	40	50	0.95	SOX11	TPS43	TIP15W
	5	MVX3600X5F40	●	2	180	187	217	282	40	50	0.95	SOX11	TPS43	TIP15W
	6	MVX3600X6F40	●	2	216	223	253	318	40	50	0.94	SOX11	TPS43	TIP15W

\* Spannmoment (N • m) : TPS4=3.5, TPS43=3.5

WSP BESCHREIBUNG > M166  
 SCHNITTBEDINGUNGEN > M167  
 VERSTELLHÜLSEN > M170

EINSATZ HINWEISE > M171  
 ERSATZTEILE > N001  
 TECHNISCHE DATEN > P001



# BOHREN (WSP AUSFÜHRUNG)

HARTMETALL

# MVX

BOHREN



M

DC (mm)	Bohrtiefe (L/D)	Bestellnummer	Lager	Zähne	Abmessungen (mm)						S10 (mm)	WSP		
					LU	LBX	LPR	OAL	DCONMS	DCSFMS				
					Klemmschraube	Schlüssel								
37.0	2	MVX3700X2F40	●	2	74	81	111	176	40	50	0.87	SOX11	TPS43	TIP15W
	3	MVX3700X3F40	●	2	111	118	148	213	40	50	0.87	SOX11	TPS43	TIP15W
	4	MVX3700X4F40	●	2	148	155	185	250	40	50	0.87	SOX11	TPS43	TIP15W
	5	MVX3700X5F40	●	2	185	192	222	287	40	50	0.87	SOX11	TPS43	TIP15W
	6	MVX3700X6F40	●	2	222	229	259	324	40	50	0.86	SOX11	TPS43	TIP15W
38.0	2	MVX3800X2F40	●	2	76	83	113	178	40	50	0.79	SOX11	TPS43	TIP15W
	3	MVX3800X3F40	●	2	114	121	151	216	40	50	0.79	SOX11	TPS43	TIP15W
	4	MVX3800X4F40	●	2	152	159	189	254	40	50	0.79	SOX11	TPS43	TIP15W
	5	MVX3800X5F40	●	2	190	197	227	292	40	50	0.79	SOX11	TPS43	TIP15W
	6	MVX3800X6F40	●	2	228	235	265	330	40	50	0.78	SOX11	TPS43	TIP15W
39.0	2	MVX3900X2F40	●	2	78	85	115	180	40	50	0.71	SOX11	TPS43	TIP15W
	3	MVX3900X3F40	●	2	117	124	154	219	40	50	0.71	SOX11	TPS43	TIP15W
	4	MVX3900X4F40	●	2	156	163	193	258	40	50	0.71	SOX11	TPS43	TIP15W
	5	MVX3900X5F40	●	2	195	202	232	297	40	50	0.71	SOX11	TPS43	TIP15W
	6	MVX3900X6F40	●	2	234	241	271	336	40	50	0.7	SOX11	TPS43	TIP15W
40.0	2	MVX4000X2F40	●	2	80	87	117	182	40	50	1.46	SOX13	TPS43	TIP15W
	3	MVX4000X3F40	●	2	120	127	157	222	40	50	1.46	SOX13	TPS43	TIP15W
	4	MVX4000X4F40	●	2	160	167	197	262	40	50	1.46	SOX13	TPS43	TIP15W
	5	MVX4000X5F40	●	2	200	207	237	302	40	50	1.46	SOX13	TPS43	TIP15W
	6	MVX4000X6F40	●	2	240	247	277	342	40	50	1.45	SOX13	TPS43	TIP15W
41.0	2	MVX4100X2F40	●	2	82	89	119	184	40	50	1.36	SOX13	TPS43	TIP15W
	3	MVX4100X3F40	●	2	123	130	160	225	40	50	1.36	SOX13	TPS43	TIP15W
	4	MVX4100X4F40	●	2	164	171	201	266	40	50	1.36	SOX13	TPS43	TIP15W
	5	MVX4100X5F40	●	2	205	212	242	307	40	50	1.36	SOX13	TPS43	TIP15W
	6	MVX4100X6F40	●	2	246	253	283	348	40	50	1.35	SOX13	TPS43	TIP15W
42.0	2	MVX4200X2F40	●	2	84	91	121	186	40	50	1.27	SOX13	TPS43	TIP15W
	3	MVX4200X3F40	●	2	126	133	163	228	40	50	1.27	SOX13	TPS43	TIP15W
	4	MVX4200X4F40	●	2	168	175	205	270	40	63	1.27	SOX13	TPS43	TIP15W
	5	MVX4200X5F40	●	2	210	217	247	312	40	63	1.27	SOX13	TPS43	TIP15W
	6	MVX4200X6F40	●	2	252	259	289	354	40	63	1.27	SOX13	TPS43	TIP15W
	4	MVX4200X4F50	★	2	168	175	205	280	50	63	1.27	SOX13	TPS43	TIP15W
	5	MVX4200X5F50	★	2	210	217	247	322	50	63	1.27	SOX13	TPS43	TIP15W
6	MVX4200X6F50	★	2	252	259	289	364	50	63	1.26	SOX13	TPS43	TIP15W	
43.0	2	MVX4300X2F40	●	2	86	93	123	188	40	50	1.18	SOX13	TPS43	TIP15W
	3	MVX4300X3F40	●	2	129	136	166	231	40	50	1.18	SOX13	TPS43	TIP15W
	4	MVX4300X4F40	●	2	172	179	209	274	40	63	1.18	SOX13	TPS43	TIP15W
	5	MVX4300X5F40	●	2	215	222	252	317	40	63	1.18	SOX13	TPS43	TIP15W
	6	MVX4300X6F40	●	2	258	265	295	360	40	63	1.17	SOX13	TPS43	TIP15W
	4	MVX4300X4F50	★	2	172	179	209	284	50	63	1.18	SOX13	TPS43	TIP15W
	5	MVX4300X5F50	★	2	215	222	252	327	50	63	1.18	SOX13	TPS43	TIP15W
6	MVX4300X6F50	★	2	258	265	295	370	50	63	1.17	SOX13	TPS43	TIP15W	
44.0	2	MVX4400X2F40	●	2	88	95	125	190	40	50	1.08	SOX13	TPS43	TIP15W
	3	MVX4400X3F40	●	2	132	139	169	234	40	50	1.08	SOX13	TPS43	TIP15W
	4	MVX4400X4F40	●	2	176	183	213	278	40	63	1.08	SOX13	TPS43	TIP15W
	5	MVX4400X5F40	●	2	220	227	257	322	40	63	1.08	SOX13	TPS43	TIP15W
	4	MVX4400X4F50	★	2	176	183	213	288	50	63	1.08	SOX13	TPS43	TIP15W
5	MVX4400X5F50	★	2	220	227	257	332	50	63	1.08	SOX13	TPS43	TIP15W	

\* Spannmoment (N · m) : TPS43=3.5

● : Lagerstandard. ★ : Lagerstandard in Japan.



DC (mm)	Bohrtiefe (L/D)	Bestellnummer	Lager	Zähne	Abmessungen (mm)						S10 (mm)	WSP		
					LU	LBX	LPR	OAL	DCONMS	DCSFMS				
45.0	2	MVX4500X2F40	●	2	90	97	127	192	40	50	0.99	SOX13	TPS43	TIP15W
	3	MVX4500X3F40	●	2	135	142	172	237	40	50	0.99	SOX13	TPS43	TIP15W
	4	MVX4500X4F40	●	2	180	187	217	282	40	63	0.99	SOX13	TPS43	TIP15W
	5	MVX4500X5F40	●	2	225	232	262	327	40	63	0.99	SOX13	TPS43	TIP15W
	4	MVX4500X4F50	★	2	180	187	217	292	50	63	0.99	SOX13	TPS43	TIP15W
	5	MVX4500X5F50	★	2	225	232	262	337	50	63	0.99	SOX13	TPS43	TIP15W
46.0	2	MVX4600X2F40	●	2	92	99	129	194	40	50	0.89	SOX13	TPS43	TIP15W
	3	MVX4600X3F40	●	2	138	145	175	240	40	50	0.89	SOX13	TPS43	TIP15W
	4	MVX4600X4F40	●	2	184	191	221	286	40	63	0.89	SOX13	TPS43	TIP15W
	5	MVX4600X5F40	●	2	230	237	267	332	40	63	0.89	SOX13	TPS43	TIP15W
	4	MVX4600X4F50	★	2	184	191	221	296	50	63	0.89	SOX13	TPS43	TIP15W
	5	MVX4600X5F50	★	2	230	237	267	342	50	63	0.89	SOX13	TPS43	TIP15W
47.0	2	MVX4700X2F40	●	2	94	101	141	206	40	63	1.9	SOX16	TPS54	TIP25D
	3	MVX4700X3F40	●	2	141	148	188	253	40	63	1.9	SOX16	TPS54	TIP25D
	4	MVX4700X4F40	●	2	188	195	235	300	40	63	1.9	SOX16	TPS54	TIP25D
	5	MVX4700X5F40	●	2	235	242	282	347	40	63	1.9	SOX16	TPS54	TIP25D
	4	MVX4700X4F50	★	2	188	195	235	310	50	63	1.9	SOX16	TPS54	TIP25D
	5	MVX4700X5F50	★	2	235	242	282	357	50	63	1.9	SOX16	TPS54	TIP25D
48.0	2	MVX4800X2F40	●	2	96	103	143	208	40	63	1.8	SOX16	TPS54	TIP25D
	3	MVX4800X3F40	●	2	144	151	191	256	40	63	1.8	SOX16	TPS54	TIP25D
	4	MVX4800X4F40	●	2	192	199	239	304	40	63	1.8	SOX16	TPS54	TIP25D
	5	MVX4800X5F40	●	2	240	247	287	352	40	63	1.8	SOX16	TPS54	TIP25D
	4	MVX4800X4F50	★	2	192	199	239	314	50	63	1.8	SOX16	TPS54	TIP25D
	5	MVX4800X5F50	★	2	240	247	287	362	50	63	1.8	SOX16	TPS54	TIP25D
49.0	2	MVX4900X2F40	●	2	98	105	145	210	40	63	1.7	SOX16	TPS54	TIP25D
	3	MVX4900X3F40	●	2	147	154	194	259	40	63	1.7	SOX16	TPS54	TIP25D
	4	MVX4900X4F40	●	2	196	203	243	308	40	63	1.7	SOX16	TPS54	TIP25D
	5	MVX4900X5F40	●	2	245	252	292	357	40	63	1.7	SOX16	TPS54	TIP25D
	4	MVX4900X4F50	★	2	196	203	243	318	50	63	1.7	SOX16	TPS54	TIP25D
	5	MVX4900X5F50	★	2	245	252	292	367	50	63	1.7	SOX16	TPS54	TIP25D
50.0	2	MVX5000X2F40	●	2	100	107	147	212	40	63	1.6	SOX16	TPS54	TIP25D
	3	MVX5000X3F40	●	2	150	157	197	262	40	63	1.6	SOX16	TPS54	TIP25D
	4	MVX5000X4F40	●	2	200	207	247	312	40	63	1.6	SOX16	TPS54	TIP25D
	5	MVX5000X5F40	●	2	250	257	297	362	40	63	1.6	SOX16	TPS54	TIP25D
	4	MVX5000X4F50	★	2	200	207	247	322	50	63	1.6	SOX16	TPS54	TIP25D
	5	MVX5000X5F50	★	2	250	257	297	372	50	63	1.6	SOX16	TPS54	TIP25D
51.0	2	MVX5100X2F40	●	2	102	109	149	214	40	63	1.5	SOX16	TPS54	TIP25D
	3	MVX5100X3F40	●	2	153	160	200	265	40	63	1.5	SOX16	TPS54	TIP25D
	4	MVX5100X4F40	●	2	204	211	251	316	40	63	1.5	SOX16	TPS54	TIP25D
	5	MVX5100X5F40	●	2	255	262	302	367	40	63	1.5	SOX16	TPS54	TIP25D
	4	MVX5100X4F50	★	2	204	211	251	326	50	63	1.5	SOX16	TPS54	TIP25D
	5	MVX5100X5F50	★	2	255	262	302	377	50	63	1.5	SOX16	TPS54	TIP25D
52.0	2	MVX5200X2F40	●	2	104	111	151	216	40	63	1.39	SOX16	TPS54	TIP25D
	3	MVX5200X3F40	●	2	156	163	203	268	40	63	1.39	SOX16	TPS54	TIP25D
	4	MVX5200X4F40	●	2	208	215	255	320	40	63	1.39	SOX16	TPS54	TIP25D
	5	MVX5200X5F40	●	2	260	267	307	372	40	63	1.39	SOX16	TPS54	TIP25D
	4	MVX5200X4F50	★	2	208	215	255	330	50	63	1.39	SOX16	TPS54	TIP25D
	5	MVX5200X5F50	★	2	260	267	307	382	50	63	1.39	SOX16	TPS54	TIP25D

\* Spannmoment (N • m) : TPS43=3.5, TPS54=7.5

WSP BESCHREIBUNG > M166  
 SCHNITTBEDINGUNGEN > M167  
 VERSTELLHÜLSEN > M170



EINSATZ HINWEISE > M171  
 ERSATZTEILE > N001  
 TECHNISCHE DATEN > P001

# BOHREN (WSP AUSFÜHRUNG)

HARTMETALL



# MVX

M  
BOHREN

DC (mm)	Bohrtiefe (L/D)	Bestellnummer	Lager	Zähne	Abmessungen (mm)						S10 (mm)	WSP		
					LU	LBX	LPR	OAL	DCONMS	DCSFMS				
53.0	2	MVX5300X2F40	●	2	106	113	153	218	40	63	1.29	SOX16	TPS54	TIP25D
	3	MVX5300X3F40	●	2	159	166	206	271	40	63	1.29	SOX16	TPS54	TIP25D
	4	MVX5300X4F40	●	2	212	219	259	324	40	63	1.29	SOX16	TPS54	TIP25D
	5	MVX5300X5F40	●	2	265	272	312	377	40	63	1.29	SOX16	TPS54	TIP25D
	5	MVX5300X5F50	★	2	212	219	259	334	50	63	1.29	SOX16	TPS54	TIP25D
54.0	2	MVX5400X2F40	●	2	108	115	155	220	40	63	1.19	SOX16	TPS54	TIP25D
	3	MVX5400X3F40	●	2	162	169	209	274	40	63	1.19	SOX16	TPS54	TIP25D
	4	MVX5400X4F40	●	2	216	223	263	328	40	63	1.19	SOX16	TPS54	TIP25D
	5	MVX5400X5F40	●	2	270	277	317	382	40	63	1.19	SOX16	TPS54	TIP25D
	5	MVX5400X5F50	★	2	216	223	263	338	50	63	1.19	SOX16	TPS54	TIP25D
55.0	2	MVX5500X2F40	●	2	110	117	157	222	40	63	1.08	SOX16	TPS54	TIP25D
	3	MVX5500X3F40	●	2	165	172	212	277	40	63	1.08	SOX16	TPS54	TIP25D
	4	MVX5500X4F40	●	2	220	227	267	332	40	63	1.08	SOX16	TPS54	TIP25D
	5	MVX5500X5F40	●	2	275	282	322	387	40	63	1.08	SOX16	TPS54	TIP25D
	5	MVX5500X5F50	★	2	220	227	267	342	50	63	1.08	SOX16	TPS54	TIP25D
56.0	2	MVX5600X2F40	●	2	112	119	159	224	40	63	0.98	SOX16	TPS54	TIP25D
	3	MVX5600X3F40	●	2	168	175	215	280	40	63	0.98	SOX16	TPS54	TIP25D
	4	MVX5600X4F40	●	2	224	231	271	336	40	63	0.98	SOX16	TPS54	TIP25D
	5	MVX5600X5F40	●	2	280	287	327	392	40	63	0.98	SOX16	TPS54	TIP25D
	5	MVX5600X5F50	★	2	224	231	271	346	50	63	0.98	SOX16	TPS54	TIP25D
57.0	2	MVX5700X2F40	●	2	114	121	161	226	40	68	1.47	SOX18	TPS54	TIP25D
	3	MVX5700X3F40	●	2	171	178	218	283	40	68	1.47	SOX18	TPS54	TIP25D
	4	MVX5700X4F40	●	2	228	235	275	340	40	68	1.47	SOX18	TPS54	TIP25D
	5	MVX5700X5F40	●	2	285	292	332	397	40	68	1.47	SOX18	TPS54	TIP25D
	5	MVX5700X5F50	★	2	228	235	275	350	50	68	1.47	SOX18	TPS54	TIP25D
58.0	2	MVX5800X2F40	●	2	116	123	163	228	40	68	1.37	SOX18	TPS54	TIP25D
	3	MVX5800X3F40	●	2	174	181	221	286	40	68	1.37	SOX18	TPS54	TIP25D
	4	MVX5800X4F40	●	2	232	239	279	344	40	68	1.37	SOX18	TPS54	TIP25D
	5	MVX5800X5F40	●	2	290	297	337	402	40	68	1.37	SOX18	TPS54	TIP25D
	5	MVX5800X5F50	★	2	232	239	279	354	50	68	1.37	SOX18	TPS54	TIP25D
59.0	2	MVX5900X2F40	●	2	118	125	165	230	40	68	1.26	SOX18	TPS54	TIP25D
	3	MVX5900X3F40	●	2	177	184	224	289	40	68	1.26	SOX18	TPS54	TIP25D
	4	MVX5900X4F40	●	2	236	243	283	348	40	68	1.26	SOX18	TPS54	TIP25D
	5	MVX5900X5F40	●	2	295	302	342	407	40	68	1.26	SOX18	TPS54	TIP25D
	5	MVX5900X5F50	★	2	236	243	283	358	50	68	1.26	SOX18	TPS54	TIP25D
60.0	2	MVX6000X2F40	●	2	120	127	167	232	40	68	1.16	SOX18	TPS54	TIP25D
	3	MVX6000X3F40	●	2	180	187	227	292	40	68	1.16	SOX18	TPS54	TIP25D
	4	MVX6000X4F40	●	2	240	247	287	352	40	68	1.16	SOX18	TPS54	TIP25D
	5	MVX6000X5F40	●	2	300	307	347	412	40	68	1.16	SOX18	TPS54	TIP25D
	5	MVX6000X5F50	★	2	240	247	287	362	50	68	1.16	SOX18	TPS54	TIP25D

\* Spannmoment (N • m) : TPS54=7.5

● : Lagerstandard. ★ : Lagerstandard in Japan.

DC (mm)	Bohrtiefe (L/D)	Bestellnummer	Lager	Zähne	Abmessungen (mm)						S10 (mm)	WSP		
					LU	LBX	LPR	OAL	DCONMS	DCSFMS				
61.0	2	MVX6100X2F40	●	2	122	129	169	234	40	68	1.05	SOX18	TPS54	TIP25D
	3	MVX6100X3F40	●	2	183	190	230	295	40	68	1.05	SOX18	TPS54	TIP25D
	4	MVX6100X4F40	●	2	244	251	291	356	40	68	1.05	SOX18	TPS54	TIP25D
	5	MVX6100X5F40	●	2	305	312	352	417	40	68	1.05	SOX18	TPS54	TIP25D
	4	MVX6100X4F50	★	2	244	251	291	366	50	68	1.05	SOX18	TPS54	TIP25D
	5	MVX6100X5F50	★	2	305	312	352	427	50	68	1.05	SOX18	TPS54	TIP25D
62.0	2	MVX6200X2F40	●	2	124	131	171	236	40	68	0.95	SOX18	TPS54	TIP25D
	3	MVX6200X3F40	●	2	186	193	233	298	40	68	0.95	SOX18	TPS54	TIP25D
	4	MVX6200X4F40	●	2	248	255	295	360	40	68	0.95	SOX18	TPS54	TIP25D
	5	MVX6200X5F40	●	2	310	317	357	422	40	68	0.95	SOX18	TPS54	TIP25D
	4	MVX6200X4F50	★	2	248	255	295	370	50	68	0.95	SOX18	TPS54	TIP25D
	5	MVX6200X5F50	★	2	310	317	357	432	50	68	0.95	SOX18	TPS54	TIP25D
63.0	2	MVX6300X2F40	●	2	126	133	173	238	40	68	0.85	SOX18	TPS54	TIP25D
	3	MVX6300X3F40	●	2	189	196	236	301	40	68	0.85	SOX18	TPS54	TIP25D
	4	MVX6300X4F40	●	2	252	259	299	364	40	68	0.85	SOX18	TPS54	TIP25D
	5	MVX6300X5F40	●	2	315	322	362	427	40	68	0.85	SOX18	TPS54	TIP25D
	4	MVX6300X4F50	★	2	252	259	299	374	50	68	0.85	SOX18	TPS54	TIP25D
	5	MVX6300X5F50	★	2	315	322	362	437	50	68	0.85	SOX18	TPS54	TIP25D

\* Spannmoment (N · m) : TPS54=7.5

M

BOHREN

WSP BESCHREIBUNG > M166  
 SCHNITTBEDINGUNGEN > M167  
 VERSTELLHÜLSEN > M170

EINSATZ HINWEISE > M171  
 ERSATZTEILE > N001  
 TECHNISCHE DATEN > P001

M165









# BOHREN (WSP AUSFÜHRUNG)

# MVX

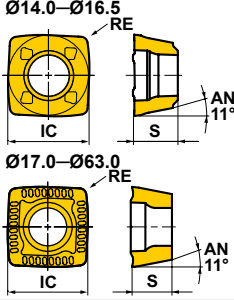
HARTMETALL

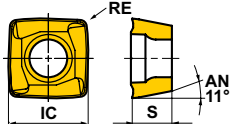

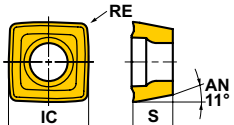

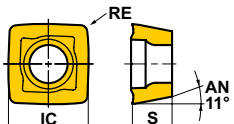







## WSP

M  
BOHREN

Form	Bohrer-Durchm.	WSP-Nummer	Abmessungen (mm)			Beschichtet				Hartmetall		Geometrie
			IC	S	RE	VP15TF	MC1020	MC5020	DP8020	TF15		
  Allgemeine Anwendung und Innen- oder Außenschniede	Ø14.0—Ø16.5	SOMX052704-UM	5.0	2.7	0.4	●	●	●				
	Ø17.0—Ø19.5	SOMX063005-UM	6.0	3.0	0.5	●	●	●				
	Ø20.0—Ø22.5	SOMX073505-UM	7.0	3.5	0.5	●	●	●				
	Ø23.0—Ø27.5	SOMX084005-UM	8.3	4.0	0.5	●	●	●				
	Ø28.0—Ø33.0	SOMX094506-UM	9.7	4.5	0.6	●	●	●				
	Ø33.5—Ø39.0	SOMX115506-UM	11.6	5.5	0.6	●	●	●				
	Ø40.0—Ø46.0	SOMX136008-UM	13.8	6.0	0.8	●	●	●				
	Ø47.0—Ø56.0	SOMX166508-UM	16.5	6.5	0.8	●	●	●				
Ø57.0—Ø63.0	SOMX187008-UM	18.2	7.0	0.8	●	●	●					
 Für rostfreien Stahl und innere Schniede	Ø17.0—Ø19.5	SOMX063005-US	6.0	3.0	0.5	●						
	Ø20.0—Ø22.5	SOMX073505-US	7.0	3.5	0.5	●						
	Ø23.0—Ø27.5	SOMX084005-US	8.0	4.0	0.5	●						
	Ø28.0—Ø33.0	SOMX094506-US	9.0	4.5	0.6	●						
	Ø33.5—Ø39.0	SOMX115506-US	11.6	5.5	0.6	●						
	Ø40.0—Ø46.0	SOMX136008-US	13.8	6.0	0.8	●						
	Ø47.0—Ø56.0	SOMX166508-US	16.5	6.5	0.8	●						
	Ø57.0—Ø63.0	SOMX187008-US	18.2	7.0	0.8	●						
 Stabile Schneidkantenaustrführung und Innenschniede	Ø17.0—Ø19.5	SOMX062905-UH	6.0	2.9	0.5				●			
	Ø20.0—Ø22.5	SOMX073405-UH	7.0	3.4	0.5				●			
	Ø23.0—Ø27.5	SOMX083905-UH	8.3	3.9	0.5				●			
	Ø28.0—Ø33.0	SOMX094406-UH	9.7	4.4	0.6				●			
	Ø33.5—Ø39.0	SOMX115406-UH	11.6	5.4	0.6				●			
	Ø40.0—Ø46.0	SOMX135908-UH	13.8	5.9	0.8				●			
	Ø47.0—Ø56.0	SOMX166408-UH	16.5	6.4	0.8				●			
	Ø57.0—Ø63.0	SOMX186908-UH	18.2	6.9	0.8				●			
 Aluminiumlegierung und Innen- oder Außenschniede	Ø17.0—Ø19.5	SOGX063005-UN	6.0	3.0	0.5					●		
	Ø20.0—Ø22.5	SOGX073505-UN	7.0	3.5	0.5					●		
	Ø23.0—Ø27.5	SOGX084005-UN	8.3	4.0	0.5					●		
	Ø28.0—Ø33.0	SOGX094506-UN	9.7	4.5	0.6					●		
	Ø33.5—Ø39.0	SOGX115506-UN	11.6	5.5	0.6					●		
	Ø40.0—Ø46.0	SOGX136008-UN	13.8	6.0	0.8					●		
	Ø47.0—Ø56.0	SOGX166508-UN	16.5	6.5	0.8					●		
	Ø57.0—Ø63.0	SOGX187008-UN	18.2	7.0	0.8					●		

Hinweis 1) MC1020 und MC5020 sind ausschließlich für den Einsatz als Außenschniede konzipiert worden. DP8020 sind ausschließlich für den Einsatz als Innenschniede konzipiert.

## WSP-EMPFEHLUNGEN

	1. Empfehlung		Bei Ausbrüchen an der äußeren WSP	
	Äußere WSP	Innere WSP	Äußere WSP	Innere WSP
<b>P</b> Baustahl, Legierter Stahl	MC1020 	VP15TF 	VP15TF 	VP15TF 
	UM-Spanbrecher	UM-Spanbrecher	UM-Spanbrecher	UM-Spanbrecher
<b>M</b> Rostfreier Stahl	MC1020 	VP15TF 	VP15TF 	VP15TF 
	UM-Spanbrecher	US-Spanbrecher	UM-Spanbrecher	US-Spanbrecher
<b>K</b> Gusseisen	MC5020 	VP15TF 	VP15TF 	VP15TF 
	UM-Spanbrecher	UM-Spanbrecher	UM-Spanbrecher	UM-Spanbrecher

	1. Empfehlung		Bei Ausbrüchen an der äußeren WSP	
	Äußere WSP	Innere WSP	Äußere WSP	Innere WSP
<b>H</b> Gehärteter Stahl	MC1020 	DP8020 	VP15TF 	DP8020 
	UM-Spanbrecher	UH-Spanbrecher	UM-Spanbrecher	UH-Spanbrecher
<b>N</b> Aluminium- legierung	TF15 	TF15 		
	UN-Spanbrecher	UN-Spanbrecher		

● : Lagerstandard.

## SCHNITTDATENEMPFEHLUNGEN

Material	Härte	Vc (m/min)	Spanbrecher	Ø 14 – Ø 16.5				
				fr (mm/U)				
				L/D=2, 3	4	5		
<b>P</b>	Baustahl (C15, Ck15)	≤180HB	200 (180–235)	UM	0.05 (0.04–0.06)	0.05 (0.04–0.06)	0.05 (0.04–0.06)	
				UH	–	–	–	
	C-Stahl, legierter Stahl (Ck45, 41CrMo4)	180–280HB	140 (115–180)	UM	0.08 (0.06–0.14)	0.08 (0.06–0.09)	0.08 (0.06–0.09)	
				UH	–	–	–	
	C-Stahl, legierter Stahl (100Cr6)	280–350HB	100 (75–140)	UM	0.08 (0.06–0.14)	0.08 (0.06–0.09)	0.08 (0.06–0.09)	
				UH	–	–	–	
	Legierter Werkzeugstahl (X210Cr12)	≤350HB	135 (100–170)	UM	0.08 (0.06–0.14)	0.08 (0.06–0.09)	0.08 (0.06–0.09)	
				UH	–	–	–	
<b>M</b>	Austenitisch rostfreier Stahl (X5CrNi18-10, X5CrNiMo17-12-2)	≤200HB	130 (80–180)	US	–	–	–	
				UM	0.06 (0.04–0.08)	0.05 (0.04–0.06)	0.05 (0.04–0.06)	
	Austenitisch rostfreier Stahl (X2CrNiN18-9, X5CrNiMoN17-11-2)	>200HB	130 (80–180)	US	–	–	–	
				UM	0.06 (0.04–0.08)	0.05 (0.04–0.06)	0.05 (0.04–0.06)	
	Rostfreie Stähle, ferritisch und martensitisch (X12Cr13, X6Cr17)	≤200HB	120 (80–165)	US	–	–	–	
				UM	0.06 (0.04–0.08)	0.05 (0.04–0.06)	0.05 (0.04–0.06)	
	Rostfreie Stähle, ferritisch und martensitisch (X17CrNi16-2, X30Cr13)	>200HB	120 (80–165)	US	–	–	–	
				UM	0.06 (0.04–0.08)	0.05 (0.04–0.06)	0.05 (0.04–0.06)	
	<b>K</b>	Guss (GG25, GG30)	≤350MPa	160 (130–195)	UM	0.10 (0.06–0.14)	0.08 (0.06–0.10)	0.08 (0.06–0.10)
		Duktiler Guss (GG40)	≤450MPa	100 (80–135)	UM	0.10 (0.06–0.14)	0.08 (0.06–0.10)	0.08 (0.06–0.10)
Duktiler Guss (GGG70)		≤800HB	100 (70–125)	UM	0.08 (0.06–0.12)	0.07 (0.06–0.08)	0.07 (0.06–0.08)	
<b>N</b>	Aluminiumlegierung (AlMg1SiCu, Al-Zn6MgCu)	Si<5%	200 (100-350)	UN	–	–	–	
	Aluminiumlegierung (AlSi9Cu3)	5%≤Si≤10%	150 (100-200)	UN	–	–	–	
	Aluminiumlegierung (AlSi11Cu2, AlSi17Cu4Mg)	Si>10%	150 (100-200)	UN	–	–	–	
<b>H</b>	Gehärteter Stahl (X40CrMoV51, 55NiCrMoV6)	38 - 45HRC	50 (30-80)	UH	–	–	–	

Hinweis 1) Schnittgeschwindigkeit um 30 % reduzieren, wenn VP15TF als äußere WSP verwendet wird.  
Hinweis 2) L/D=3 ist die empfohlene maximale Tiefe, wenn ausschließlich externe Kühlung verwendet wird.  
Hinweis 3) Interne Kühlkanäle sind beim Bohren von rostfreien Stählen unerlässlich.

EINSATZ HINWEISE > M171  
ERSATZTEILE > N001  
TECHNISCHE DATEN > P001

M

BOHREN

## SCHNITTDATENEMPFEHLUNGEN

Material	Härte	Vc (m/min)	Spanbrecher	Ø 17–Ø 19.5				
				fr (mm/U)				
				L/D=2, 3	4	5	6	
<b>P</b> Baustahl (C15, Ck15)	≤180HB	200 (180–235)	UM	0.05 (0.04–0.06)	0.05 (0.04–0.06)	0.05 (0.04–0.06)	0.04 (0.04–0.05)	
			UH					
	180–280HB	140 (115–180)	UM	0.08 (0.06–0.14)	0.08 (0.06–0.09)	0.08 (0.06–0.09)	0.05 (0.04–0.06)	
			UH					
	280–350HB	100 (75–140)	UM	0.08 (0.06–0.14)	0.08 (0.06–0.09)	0.08 (0.06–0.09)	0.05 (0.04–0.06)	
			UH					
	≤350HB	135 (100–170)	UM	0.08 (0.06–0.14)	0.08 (0.06–0.09)	0.08 (0.06–0.09)	0.05 (0.04–0.06)	
			UH					
<b>M</b> Austenitisch rostfreier Stahl (X5CrNi18-10, X5CrNiMo17-12-2)	≤200HB	130 (80–180)	US	0.08 (0.06–0.12)	0.06 (0.04–0.08)	0.06 (0.04–0.08)	0.05 (0.04–0.06)	
			UM	0.06 (0.04–0.08)	0.05 (0.04–0.06)	0.05 (0.04–0.06)	0.04 (0.04–0.05)	
	>200HB	130 (80–180)	US	0.08 (0.06–0.12)	0.06 (0.04–0.08)	0.06 (0.04–0.08)	0.05 (0.04–0.06)	
			UM	0.06 (0.04–0.08)	0.05 (0.04–0.06)	0.05 (0.04–0.06)	0.04 (0.04–0.05)	
	≤200HB	120 (80–165)	US	0.08 (0.06–0.12)	0.06 (0.04–0.08)	0.06 (0.04–0.08)	0.05 (0.04–0.06)	
			UM	0.06 (0.04–0.08)	0.05 (0.04–0.06)	0.05 (0.04–0.06)	0.04 (0.04–0.05)	
	>200HB	120 (80–165)	US	0.08 (0.06–0.12)	0.06 (0.04–0.08)	0.06 (0.04–0.08)	0.05 (0.04–0.06)	
			UM	0.06 (0.04–0.08)	0.05 (0.04–0.06)	0.05 (0.04–0.06)	0.04 (0.04–0.05)	
	<b>K</b> Guss (GG25, GG30)	≤350MPa	160 (130–195)	UM	0.11 (0.08–0.14)	0.09 (0.08–0.10)	0.09 (0.08–0.10)	0.05 (0.04–0.06)
		≤450MPa	100 (80–135)	UM	0.11 (0.08–0.14)	0.09 (0.08–0.10)	0.09 (0.08–0.10)	0.05 (0.04–0.06)
≤800HB		100 (70–125)	UM	0.11 (0.08–0.14)	0.09 (0.08–0.10)	0.09 (0.08–0.10)	0.05 (0.04–0.06)	
<b>N</b> Aluminiumlegierung (AlMg1SiCu, Al-Zn6MgCu)	Si<5%	200 (100-350)	UN	0.12 (0.05–0.18)	0.12 (0.05–0.18)	0.12 (0.05–0.18)	0.08 (0.05–0.12)	
	5%≤Si≤10%	150 (100-200)	UN	0.12 (0.05–0.18)	0.12 (0.05–0.18)	0.12 (0.05–0.18)	0.08 (0.05–0.12)	
	Si>10%	150 (100-200)	UN	0.12 (0.05–0.18)	0.12 (0.05–0.18)	0.12 (0.05–0.18)	0.08 (0.05–0.12)	
<b>H</b> Gehärteter Stahl (X40CrMoV51, 55NiCrMoV6)	38 - 45HRC	50 (30-80)	UH	0.08 (0.04–0.12)	0.06 (0.04–0.09)	–	–	

Hinweis 1) Schnittgeschwindigkeit um 30 % reduzieren, wenn VP15TF als äußere WSP verwendet wird.

Hinweis 2) L/D=3 ist die empfohlene maximale Tiefe, wenn ausschließlich externe Kühlung verwendet wird.

Hinweis 3) Interne Kühlkanäle sind beim Bohren von rostfreien Stählen unerlässlich.

	Ø 20–Ø 23.5				Ø 24–Ø 29.5				Ø 30–Ø 63			
	fr (mm/U)				fr (mm/U)				fr (mm/U)			
	L/D=2, 3	4	5	6	L/D=2, 3	4	5	6	L/D=2, 3	4	5	6
	0.06 (0.04–0.08)	0.06 (0.04–0.07)	0.06 (0.04–0.07)	0.04 (0.04–0.05)	0.07 (0.04–0.08)	0.06 (0.04–0.07)	0.06 (0.04–0.07)	0.05 (0.04–0.06)	0.08 (0.06–0.10)	0.07 (0.06–0.08)	0.07 (0.06–0.08)	0.06 (0.06–0.07)
	0.10 (0.06–0.18)	0.09 (0.06–0.12)	0.09 (0.06–0.12)	0.07 (0.06–0.08)	0.12 (0.08–0.18)	0.10 (0.08–0.12)	0.10 (0.08–0.12)	0.09 (0.08–0.10)	0.14 (0.08–0.20)	0.12 (0.08–0.16)	0.12 (0.08–0.16)	0.11 (0.10–0.12)
	0.10 (0.06–0.18)	0.09 (0.06–0.12)	0.09 (0.06–0.12)	0.07 (0.06–0.08)	0.12 (0.08–0.18)	0.10 (0.08–0.12)	0.10 (0.08–0.12)	0.09 (0.08–0.10)	0.14 (0.08–0.20)	0.12 (0.08–0.16)	0.12 (0.08–0.16)	0.11 (0.10–0.12)
	0.10 (0.06–0.18)	0.09 (0.06–0.12)	0.09 (0.06–0.12)	0.07 (0.06–0.08)	0.12 (0.08–0.18)	0.10 (0.08–0.12)	0.10 (0.08–0.12)	0.09 (0.08–0.10)	0.14 (0.08–0.20)	0.12 (0.08–0.16)	0.12 (0.08–0.16)	0.10 (0.08–0.12)
	0.10 (0.06–0.14)	0.07 (0.06–0.08)	0.07 (0.06–0.08)	0.06 (0.06–0.07)	0.10 (0.06–0.14)	0.08 (0.06–0.10)	0.08 (0.06–0.10)	0.07 (0.06–0.08)	0.10 (0.06–0.14)	0.09 (0.06–0.12)	0.09 (0.06–0.12)	0.07 (0.06–0.10)
	0.08 (0.06–0.12)	0.07 (0.06–0.08)	0.07 (0.06–0.08)	0.06 (0.06–0.07)	0.09 (0.06–0.12)	0.07 (0.06–0.09)	0.07 (0.06–0.09)	0.06 (0.06–0.08)	0.09 (0.06–0.12)	0.08 (0.06–0.10)	0.08 (0.06–0.10)	0.07 (0.06–0.08)
	0.10 (0.06–0.14)	0.07 (0.06–0.08)	0.07 (0.06–0.08)	0.06 (0.06–0.07)	0.10 (0.06–0.14)	0.08 (0.06–0.10)	0.08 (0.06–0.10)	0.07 (0.06–0.08)	0.10 (0.06–0.14)	0.09 (0.06–0.12)	0.09 (0.06–0.12)	0.07 (0.06–0.10)
	0.08 (0.06–0.12)	0.07 (0.06–0.08)	0.07 (0.06–0.08)	0.06 (0.06–0.07)	0.09 (0.06–0.12)	0.07 (0.06–0.09)	0.07 (0.06–0.09)	0.06 (0.06–0.08)	0.09 (0.06–0.12)	0.08 (0.06–0.10)	0.08 (0.06–0.10)	0.07 (0.06–0.08)
	0.10 (0.06–0.14)	0.07 (0.06–0.08)	0.07 (0.06–0.08)	0.06 (0.06–0.07)	0.10 (0.06–0.14)	0.08 (0.06–0.10)	0.08 (0.06–0.10)	0.07 (0.06–0.08)	0.10 (0.06–0.14)	0.09 (0.06–0.12)	0.09 (0.06–0.12)	0.07 (0.06–0.10)
	0.08 (0.06–0.12)	0.07 (0.06–0.08)	0.07 (0.06–0.08)	0.06 (0.06–0.07)	0.09 (0.06–0.12)	0.07 (0.06–0.09)	0.07 (0.06–0.09)	0.06 (0.06–0.08)	0.09 (0.06–0.12)	0.08 (0.06–0.10)	0.08 (0.06–0.10)	0.07 (0.06–0.08)
	0.14 (0.10–0.18)	0.10 (0.10–0.12)	0.10 (0.10–0.12)	0.07 (0.06–0.08)	0.15 (0.10–0.20)	0.11 (0.10–0.13)	0.11 (0.10–0.13)	0.09 (0.08–0.10)	0.15 (0.10–0.20)	0.12 (0.10–0.13)	0.12 (0.10–0.13)	0.11 (0.10–0.12)
	0.13 (0.10–0.16)	0.10 (0.10–0.11)	0.10 (0.10–0.11)	0.07 (0.06–0.08)	0.14 (0.10–0.18)	0.11 (0.10–0.12)	0.11 (0.10–0.12)	0.09 (0.08–0.10)	0.15 (0.10–0.20)	0.12 (0.10–0.13)	0.12 (0.10–0.13)	0.11 (0.10–0.12)
	0.13 (0.10–0.16)	0.10 (0.10–0.11)	0.10 (0.10–0.11)	0.07 (0.06–0.08)	0.14 (0.10–0.18)	0.11 (0.10–0.12)	0.11 (0.10–0.12)	0.09 (0.08–0.10)	0.15 (0.10–0.20)	0.12 (0.10–0.13)	0.12 (0.10–0.13)	0.11 (0.10–0.12)
	0.12 (0.05–0.18)	0.12 (0.05–0.18)	0.12 (0.05–0.18)	0.08 (0.05–0.12)	0.12 (0.05–0.18)	0.12 (0.05–0.18)	0.12 (0.05–0.18)	0.08 (0.05–0.12)	0.12 (0.05–0.20)	0.12 (0.05–0.18)	0.12 (0.05–0.18)	0.08 (0.05–0.12)
	0.12 (0.05–0.18)	0.12 (0.05–0.18)	0.12 (0.05–0.18)	0.08 (0.05–0.12)	0.12 (0.05–0.18)	0.12 (0.05–0.18)	0.12 (0.05–0.18)	0.08 (0.05–0.12)	0.12 (0.05–0.20)	0.12 (0.05–0.18)	0.12 (0.05–0.18)	0.08 (0.05–0.12)
	0.12 (0.05–0.18)	0.12 (0.05–0.18)	0.12 (0.05–0.18)	0.08 (0.05–0.12)	0.12 (0.05–0.18)	0.12 (0.05–0.18)	0.12 (0.05–0.18)	0.08 (0.05–0.12)	0.12 (0.05–0.20)	0.12 (0.05–0.18)	0.12 (0.05–0.18)	0.08 (0.05–0.12)
	0.09 (0.06–0.14)	0.07 (0.06–0.09)	–	–	0.09 (0.06–0.14)	0.07 (0.06–0.09)	–	–	0.11 (0.06–0.16)	0.09 (0.06–0.12)	–	–

# VERSTELLHÜLSEN [JFS]

● Für die Vergrößerung des Bohrerdurchmessers.

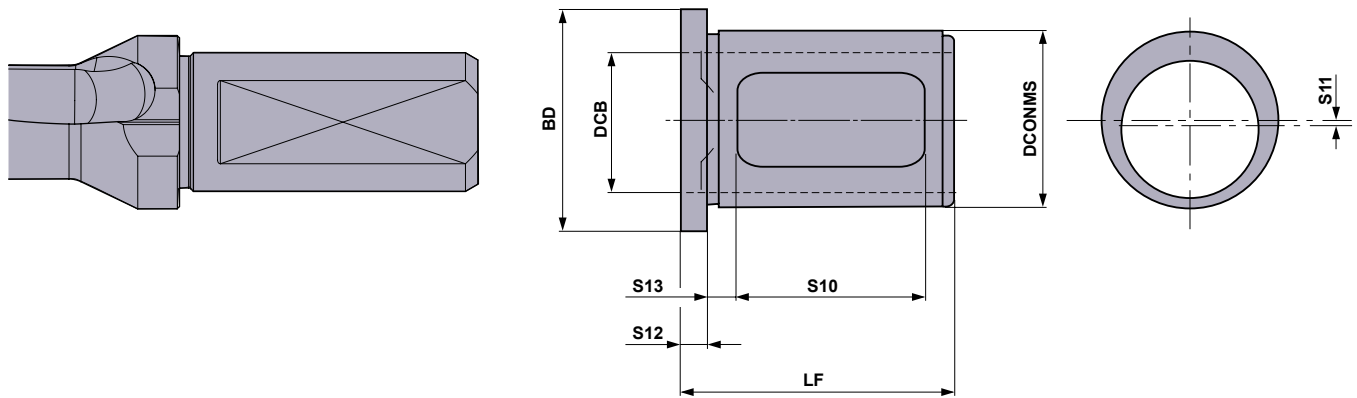

Set Bestellnummer	Individuelle Bestellnummer	Lager	Abmessungen (mm)							*Versatz (S11×2)	Passender MVX-Bohrer
			BD	DCONMS	DCB	LF	S10	S12	S13		
JFS-1	JFS2520-10	●	33	25	20	43	30	5	5	0.1	MVX1700 X ØF20
	JFS2520-20	●	33	25	20	43	30	5	5	0.2	
	JFS2520-30	●	33	25	20	43	30	5	5	0.3	
	JFS2520-40	●	33	25	20	43	30	5	5	0.4	
	JFS2520-50	●	33	25	20	43	30	5	5	0.5	
JFS-2	JFS3225-10	●	40	32	25	50	34	5	5	0.1	MVX1750 X ØF25 MVX2550 X ØF25
	JFS3225-20	●	40	32	25	50	34	5	5	0.2	
	JFS3225-30	●	40	32	25	50	34	5	5	0.3	
	JFS3225-40	●	40	32	25	50	34	5	5	0.4	
	JFS3225-50	●	40	32	25	50	34	5	5	0.5	
JFS-3	JFS4032-10	●	48	40	32	55	40	5	5	0.1	MVX2600 X ØF32 MVX3000 X ØF32
	JFS4032-20	●	48	40	32	55	40	5	5	0.2	
	JFS4032-30	●	48	40	32	55	40	5	5	0.3	
	JFS4032-40	●	48	40	32	55	40	5	5	0.4	
	JFS4032-50	●	48	40	32	55	40	5	5	0.5	
JFS-4	JFS5040-10	★	68	50	40	65	50	5	5	0.1	MVX3100 X ØF40 MVX6300 X ØF40
	JFS5040-20	★	68	50	40	65	50	5	5	0.2	
	JFS5040-30	★	68	50	40	65	50	5	5	0.3	
	JFS5040-40	★	68	50	40	65	50	5	5	0.4	
	JFS5040-50	★	68	50	40	65	50	5	5	0.5	

\*Versatz : Größe des Versatzes auf Durchmesser.

## RICHTLINIE FÜR DIE AUSWAHL VON VERSTELLHÜLSEN

Benötigt = Bohrer Ø + Verstellhülsen + 0.1mm

(z.B.) Benötigter Durchmesser ist 20.3 mm 0.1mm ist Toleranz.

$$\text{Ø}20.3 = (\text{MVX2000 X ØF25} + \text{JFS3225-20}) + 0.1$$

↓  
20mm Bohrer

↓  
Verwendung einer Hülse mit 0.2mm Versatz.

↓  
Übergröße

<Werkzeugauswahl>  
BOHRER : MVX2000 X ØF25  
Verstellhülsen [JFS]  
: JFS3225-20

Hinweis 1) Toleranzgröße kann variieren, dies ist nur eine generelle Richtlinie.

## Bestellnummer DER VERSTELLHÜLSEN

### 1. Bestellmethode

Abmaße können aufgrund der Schnittbedingungen variieren. Daher empfehlen wir die Set-Bestellung. Bei Bestellungen, benennen Sie bitte die Set Bestellnr. (5 Hülsen/ Set).

### 2. Bestellmethode

Einzelbestellungen sind möglich, bitte nennen Sie die Produktbezeichnung.

● : Lagerstandard. ★ : Lagerstandard in Japan.



## ANWENDUNGSBEREICH DER VERSTELLHÜLSEN

1. Bitte achten Sie darauf, dass beim Einbauen des Bohrers die Spannfläche des Bohrers, der Schlitz der Hülse, und die Spannschrauben in die richtige Position gebracht werden. (siehe Bild)

2. Die Schraube A spannt direkt durch den Büchenschlitz. Bei manchen Aufnahmen kann es zu Beschädigung der Hülse kommen, da der Lochabstand zu groß ist: Bitte vorab prüfen!

(Hinweis)

- Feineinstellungen können mit der Verstellhülse nicht vorgenommen werden.
- Kann nicht in Spannzangen gespannt werden.

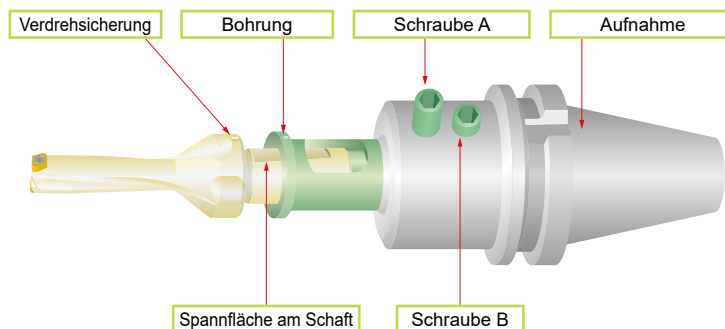

## ANWENDUNG VON MVX-BOHRERN

### ● Einsatz auf einer Drehmaschine

(1) Die äußere WSP muss zur X-Achse der Maschine parallel sein. Der Bohrer ist so konzipiert, dass die Mitte der inneren WSP etwa 0-0,15 mm tiefer liegt, wenn die Mitte des Bohrers und der Werkzeugspindel aneinander ausgerichtet werden.  
\*Die innere WSP kann brechen, wenn die Mitte der inneren WSP höher liegt als die X-Achse der Maschine.

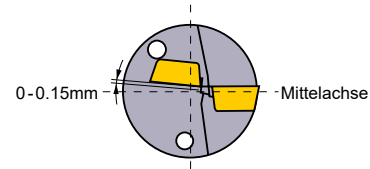

(2) Zur Einstellung des Bohrlochdurchmessers durch Versetzen des Bohrers korrigieren Sie bitte in Richtung der positiven X-Achse (Richtung, in der der Bohrlochdurchmesser erweitert wird). Hinweise zu den maximalen Einstellraten der einzelnen Halter finden Sie in den Halterabmessungen.

\*Eine Einstellung zur negativen X-Achse wird nicht empfohlen (Richtung, in der der Bohrlochdurchmesser verkleinert wird), da der Halter mit dem Bohrloch kollidieren kann.

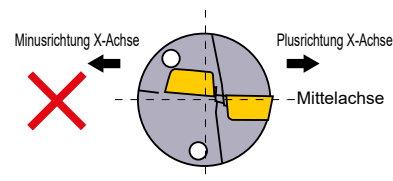

(3) Beim Bohren von Durchgangslöchern auf einer Drehmaschine kann die vom Bohrer erzeugte Scheibe mit hoher Geschwindigkeit aus dem Werkstück herausgeschleudert werden. Aus Sicherheitsgründen und zum Schutz vor Verletzungen sollte eine Schutzabdeckung angebracht werden.

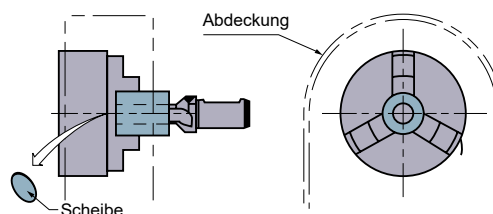

# VIOLET BOHRER

## VAPDS

Kurze Spirallänge

HSS



DC < 2

DC ≥ 2

- P
- M
- K
- N
- S
- H

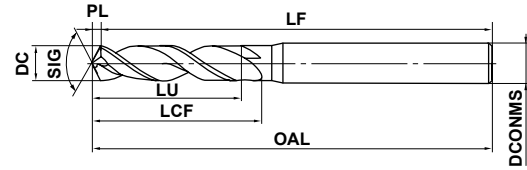

\*LU = LCF - 2DC (Max 3×DC)

0.5 ≤ DC ≤ 3	3 < DC ≤ 6	6 < DC ≤ 10	10 < DC ≤ 13
0 -0.014	0 -0.018	0 -0.022	0 -0.027

\* Bohrertoleranz: 0 - 0.009mm  
(außer Ø < 2.0mm und Ø in 0.1mm Stufen (e.g. 0.5 ; 0.6....))

BOHREN

M

● Mit der Violet-Beschichtung wird eine noch höhere Effizienz und Standzeit erreicht.

DC (mm)	Bestellnummer	Abmessungen (mm)					Lager
		LCF	OAL	LF	PL	DCONMS	
0.50	VAPDSD0050	3.2	50.2	50	0.15	3	●
0.51	VAPDSD0051	3.2	50.2	50	0.15	3	★
0.52	VAPDSD0052	3.2	50.2	50	0.16	3	★
0.53	VAPDSD0053	3.2	50.2	50	0.16	3	★
0.54	VAPDSD0054	3.2	50.2	50	0.16	3	★
0.55	VAPDSD0055	3.2	50.2	50	0.17	3	★
0.56	VAPDSD0056	4.2	50.2	50	0.17	3	★
0.57	VAPDSD0057	4.2	50.2	50	0.17	3	★
0.58	VAPDSD0058	4.2	50.2	50	0.17	3	★
0.59	VAPDSD0059	4.2	50.2	50	0.18	3	★
0.60	VAPDSD0060	5.2	50.2	50	0.18	3	★
0.61	VAPDSD0061	5.2	50.2	50	0.18	3	★
0.62	VAPDSD0062	5.2	50.2	50	0.19	3	★
0.63	VAPDSD0063	5.2	50.2	50	0.19	3	★
0.64	VAPDSD0064	5.2	50.2	50	0.19	3	★
0.65	VAPDSD0065	5.2	50.2	50	0.20	3	★
0.66	VAPDSD0066	5.2	50.2	50	0.20	3	★
0.67	VAPDSD0067	5.2	50.2	50	0.20	3	★
0.68	VAPDSD0068	5.2	50.2	50	0.20	3	★
0.69	VAPDSD0069	5.2	50.2	50	0.21	3	★
0.70	VAPDSD0070	5.2	50.2	50	0.21	3	★
0.71	VAPDSD0071	5.2	50.2	50	0.21	3	★
0.72	VAPDSD0072	5.2	50.2	50	0.22	3	★
0.73	VAPDSD0073	5.2	50.2	50	0.22	3	★
0.74	VAPDSD0074	5.2	50.2	50	0.22	3	★
0.75	VAPDSD0075	5.2	50.2	50	0.23	3	★
0.76	VAPDSD0076	5.2	50.2	50	0.23	3	★
0.77	VAPDSD0077	5.2	50.2	50	0.23	3	★
0.78	VAPDSD0078	5.2	50.2	50	0.23	3	★
0.79	VAPDSD0079	5.2	50.2	50	0.24	3	★
0.80	VAPDSD0080	5.2	50.2	50	0.24	3	★
0.81	VAPDSD0081	5.2	50.2	50	0.24	3	★
0.82	VAPDSD0082	5.3	50.3	50	0.25	3	★

DC (mm)	Bestellnummer	Abmessungen (mm)					Lager
		LCF	OAL	LF	PL	DCONMS	
0.83	VAPDSD0083	5.3	50.3	50	0.25	3	★
0.84	VAPDSD0084	5.3	50.3	50	0.25	3	★
0.85	VAPDSD0085	5.3	50.3	50	0.26	3	★
0.86	VAPDSD0086	6.3	50.3	50	0.26	3	★
0.87	VAPDSD0087	6.3	50.3	50	0.26	3	★
0.88	VAPDSD0088	6.3	50.3	50	0.26	3	★
0.89	VAPDSD0089	6.3	50.3	50	0.27	3	★
0.90	VAPDSD0090	6.3	50.3	50	0.27	3	★
0.91	VAPDSD0091	6.3	50.3	50	0.27	3	★
0.92	VAPDSD0092	6.3	50.3	50	0.28	3	★
0.93	VAPDSD0093	6.3	50.3	50	0.28	3	★
0.94	VAPDSD0094	6.3	50.3	50	0.28	3	★
0.95	VAPDSD0095	6.3	50.3	50	0.29	3	★
0.96	VAPDSD0096	6.3	50.3	50	0.29	3	★
0.97	VAPDSD0097	6.3	50.3	50	0.29	3	★
0.98	VAPDSD0098	6.3	50.3	50	0.29	3	★
0.99	VAPDSD0099	6.3	50.3	50	0.30	3	★
1.00	VAPDSD0100	6.3	50.3	50	0.3	3	●
1.01	VAPDSD0101	6.3	50.3	50	0.3	3	★
1.02	VAPDSD0102	6.3	50.3	50	0.3	3	★
1.03	VAPDSD0103	6.3	50.3	50	0.3	3	★
1.04	VAPDSD0104	6.3	50.3	50	0.3	3	★
1.05	VAPDSD0105	6.3	50.3	50	0.3	3	★
1.06	VAPDSD0106	6.3	50.3	50	0.3	3	★
1.07	VAPDSD0107	8.3	55.3	55	0.3	3	★
1.08	VAPDSD0108	8.3	55.3	55	0.3	3	★
1.09	VAPDSD0109	8.3	55.3	55	0.3	3	★
1.10	VAPDSD0110	8.3	55.3	55	0.3	3	★
1.11	VAPDSD0111	8.3	55.3	55	0.3	3	★
1.12	VAPDSD0112	8.3	55.3	55	0.3	3	★
1.13	VAPDSD0113	8.3	55.3	55	0.3	3	★
1.14	VAPDSD0114	8.3	55.3	55	0.3	3	★
1.15	VAPDSD0115	8.4	55.4	55	0.4	3	★

● : Lagerstandard. ★ : Lagerstandard in Japan.

DC (mm)	Bestellnummer	Abmessungen (mm)					Lager
		LCF	OAL	LF	PL	DCONMS	
1.16	VAPDSD0116	8.4	55.4	55	0.4	3	★
1.17	VAPDSD0117	8.4	55.4	55	0.4	3	★
1.18	VAPDSD0118	8.4	55.4	55	0.4	3	★
1.19	VAPDSD0119	8.4	55.4	55	0.4	3	★
1.20	VAPDSD0120	8.4	55.4	55	0.4	3	★
1.21	VAPDSD0121	8.4	55.4	55	0.4	3	★
1.22	VAPDSD0122	8.4	55.4	55	0.4	3	★
1.23	VAPDSD0123	8.4	55.4	55	0.4	3	★
1.24	VAPDSD0124	8.4	55.4	55	0.4	3	★
1.25	VAPDSD0125	8.4	55.4	55	0.4	3	★
1.26	VAPDSD0126	8.4	55.4	55	0.4	3	★
1.27	VAPDSD0127	8.4	55.4	55	0.4	3	★
1.28	VAPDSD0128	8.4	55.4	55	0.4	3	★
1.29	VAPDSD0129	8.4	55.4	55	0.4	3	★
1.30	VAPDSD0130	9.4	55.4	55	0.4	3	★
1.31	VAPDSD0131	9.4	55.4	55	0.4	3	★
1.32	VAPDSD0132	9.4	55.4	55	0.4	3	★
1.33	VAPDSD0133	9.4	55.4	55	0.4	3	★
1.34	VAPDSD0134	9.4	55.4	55	0.4	3	★
1.35	VAPDSD0135	9.4	55.4	55	0.4	3	★
1.36	VAPDSD0136	9.4	55.4	55	0.4	3	★
1.37	VAPDSD0137	9.4	55.4	55	0.4	3	★
1.38	VAPDSD0138	9.4	55.4	55	0.4	3	★
1.39	VAPDSD0139	9.4	55.4	55	0.4	3	★
1.40	VAPDSD0140	9.4	55.4	55	0.4	3	★
1.41	VAPDSD0141	9.4	55.4	55	0.4	3	★
1.42	VAPDSD0142	9.4	55.4	55	0.4	3	★
1.43	VAPDSD0143	9.4	55.4	55	0.4	3	★
1.44	VAPDSD0144	9.4	55.4	55	0.4	3	★
1.45	VAPDSD0145	9.4	55.4	55	0.4	3	★
1.46	VAPDSD0146	9.4	55.4	55	0.4	3	★
1.47	VAPDSD0147	9.4	55.4	55	0.4	3	★
1.48	VAPDSD0148	9.4	55.4	55	0.4	3	★
1.49	VAPDSD0149	9.5	55.5	55	0.5	3	★
1.50	VAPDSD0150	9.5	55.5	55	0.5	3	●
1.51	VAPDSD0151	11.5	55.5	55	0.5	3	★
1.52	VAPDSD0152	11.5	55.5	55	0.5	3	★
1.53	VAPDSD0153	11.5	55.5	55	0.5	3	★
1.54	VAPDSD0154	11.5	55.5	55	0.5	3	★
1.55	VAPDSD0155	11.5	55.5	55	0.5	3	★
1.56	VAPDSD0156	11.5	55.5	55	0.5	3	★
1.57	VAPDSD0157	11.5	55.5	55	0.5	3	★
1.58	VAPDSD0158	11.5	55.5	55	0.5	3	★
1.59	VAPDSD0159	11.5	55.5	55	0.5	3	★
1.60	VAPDSD0160	11.5	55.5	55	0.5	3	★
1.61	VAPDSD0161	11.5	55.5	55	0.5	3	★
1.62	VAPDSD0162	11.5	55.5	55	0.5	3	★
1.63	VAPDSD0163	11.5	55.5	55	0.5	3	★
1.64	VAPDSD0164	11.5	55.5	55	0.5	3	★
1.65	VAPDSD0165	11.5	55.5	55	0.5	3	★

DC (mm)	Bestellnummer	Abmessungen (mm)					Lager
		LCF	OAL	LF	PL	DCONMS	
1.66	VAPDSD0166	11.5	55.5	55	0.5	3	★
1.67	VAPDSD0167	11.5	55.5	55	0.5	3	★
1.68	VAPDSD0168	11.5	55.5	55	0.5	3	★
1.69	VAPDSD0169	11.5	55.5	55	0.5	3	★
1.70	VAPDSD0170	11.5	55.5	55	0.5	3	★
1.71	VAPDSD0171	11.5	55.5	55	0.5	3	★
1.72	VAPDSD0172	11.5	55.5	55	0.5	3	★
1.73	VAPDSD0173	11.5	55.5	55	0.5	3	★
1.74	VAPDSD0174	11.5	55.5	55	0.5	3	★
1.75	VAPDSD0175	11.5	55.5	55	0.5	3	★
1.76	VAPDSD0176	11.5	55.5	55	0.5	3	★
1.77	VAPDSD0177	11.5	55.5	55	0.5	3	★
1.78	VAPDSD0178	11.5	55.5	55	0.5	3	★
1.79	VAPDSD0179	11.5	55.5	55	0.5	3	★
1.80	VAPDSD0180	11.5	55.5	55	0.5	3	★
1.81	VAPDSD0181	11.5	55.5	55	0.5	3	★
1.82	VAPDSD0182	11.6	55.6	55	0.6	3	★
1.83	VAPDSD0183	11.6	55.6	55	0.6	3	★
1.84	VAPDSD0184	11.6	55.6	55	0.6	3	★
1.85	VAPDSD0185	11.6	55.6	55	0.6	3	★
1.86	VAPDSD0186	11.6	55.6	55	0.6	3	★
1.87	VAPDSD0187	11.6	55.6	55	0.6	3	★
1.88	VAPDSD0188	11.6	55.6	55	0.6	3	★
1.89	VAPDSD0189	11.6	55.6	55	0.6	3	★
1.90	VAPDSD0190	12.6	55.6	55	0.6	3	★
1.91	VAPDSD0191	12.6	60.6	60	0.6	3	★
1.92	VAPDSD0192	12.6	60.6	60	0.6	3	★
1.93	VAPDSD0193	12.6	60.6	60	0.6	3	★
1.94	VAPDSD0194	12.6	60.6	60	0.6	3	★
1.95	VAPDSD0195	12.6	60.6	60	0.6	3	★
1.96	VAPDSD0196	12.6	60.6	60	0.6	3	★
1.97	VAPDSD0197	12.6	60.6	60	0.6	3	★
1.98	VAPDSD0198	12.6	60.6	60	0.6	3	★
1.99	VAPDSD0199	12.6	60.6	60	0.6	3	★
2.00	VAPDSD0200	12.4	60.4	60	0.4	3	●
2.05	VAPDSD0205	12.4	60.4	60	0.4	3	★
2.10	VAPDSD0210	12.4	60.4	60	0.4	3	★
2.15	VAPDSD0215	12.5	60.5	60	0.5	3	★
2.20	VAPDSD0220	12.5	60.5	60	0.5	3	★
2.25	VAPDSD0225	12.5	60.5	60	0.5	3	★
2.30	VAPDSD0230	13.5	60.5	60	0.5	3	★
2.35	VAPDSD0235	13.5	60.5	60	0.5	3	★
2.40	VAPDSD0240	13.5	60.5	60	0.5	3	★
2.45	VAPDSD0245	13.5	60.5	60	0.5	3	★
2.50	VAPDSD0250	13.5	60.5	60	0.5	3	●
2.55	VAPDSD0255	13.5	60.5	60	0.5	3	★
2.60	VAPDSD0260	15.5	60.5	60	0.5	3	★
2.65	VAPDSD0265	15.6	60.6	60	0.6	3	★
2.70	VAPDSD0270	15.6	60.6	60	0.6	3	★
2.75	VAPDSD0275	15.6	60.6	60	0.6	3	★

M

BOHREN

# VIOLET BOHRER

## VAPDS

Kurze Spirallänge

HSS

M

BOHREN

DC (mm)	Bestellnummer	Abmessungen (mm)					Lager
		LCF	OAL	LF	PL	DCONMS	
2.80	VAPDSD0280	15.6	60.6	60	0.6	3	★
2.85	VAPDSD0285	15.6	60.6	60	0.6	3	★
2.90	VAPDSD0290	15.6	60.6	60	0.6	3	★
2.95	VAPDSD0295	15.6	60.6	60	0.6	3	★
3.00	VAPDSD0300	15.6	60.6	60	0.6	3	●
3.05	VAPDSD0305	17.6	70.6	70	0.6	4	★
3.10	VAPDSD0310	17.6	70.6	70	0.6	4	★
3.15	VAPDSD0315	17.7	70.7	70	0.7	4	★
3.20	VAPDSD0320	17.7	70.7	70	0.7	4	★
3.25	VAPDSD0325	17.7	70.7	70	0.7	4	★
3.30	VAPDSD0330	19.7	70.7	70	0.7	4	★
3.35	VAPDSD0335	19.7	70.7	70	0.7	4	★
3.40	VAPDSD0340	19.7	70.7	70	0.7	4	★
3.45	VAPDSD0345	19.7	70.7	70	0.7	4	★
3.50	VAPDSD0350	19.7	70.7	70	0.7	4	●
3.55	VAPDSD0355	19.7	70.7	70	0.7	4	★
3.60	VAPDSD0360	21.8	70.8	70	0.8	4	★
3.65	VAPDSD0365	21.8	70.8	70	0.8	4	★
3.70	VAPDSD0370	21.8	70.8	70	0.8	4	★
3.75	VAPDSD0375	21.8	70.8	70	0.8	4	★
3.80	VAPDSD0380	21.8	70.8	70	0.8	4	★
3.85	VAPDSD0385	21.8	70.8	70	0.8	4	★
3.90	VAPDSD0390	21.8	70.8	70	0.8	4	★
3.95	VAPDSD0395	21.8	70.8	70	0.8	4	★
4.00	VAPDSD0400	21.8	70.8	70	0.8	4	●
4.05	VAPDSD0405	21.8	80.8	80	0.8	6	★
4.10	VAPDSD0410	21.9	80.9	80	0.9	6	★
4.15	VAPDSD0415	21.9	80.9	80	0.9	6	★
4.20	VAPDSD0420	21.9	80.9	80	0.9	6	★
4.25	VAPDSD0425	21.9	80.9	80	0.9	6	★
4.30	VAPDSD0430	23.9	80.9	80	0.9	6	★
4.35	VAPDSD0435	23.9	80.9	80	0.9	6	★
4.40	VAPDSD0440	23.9	80.9	80	0.9	6	★
4.45	VAPDSD0445	23.9	80.9	80	0.9	6	★
4.50	VAPDSD0450	23.9	80.9	80	0.9	6	●
4.55	VAPDSD0455	23.9	80.9	80	0.9	6	★
4.60	VAPDSD0460	26.0	81.0	80	1.0	6	★
4.65	VAPDSD0465	26.0	81.0	80	1.0	6	★
4.70	VAPDSD0470	26.0	81.0	80	1.0	6	★
4.75	VAPDSD0475	26.0	81.0	80	1.0	6	★
4.80	VAPDSD0480	26.0	81.0	80	1.0	6	★
4.85	VAPDSD0485	26.0	81.0	80	1.0	6	★
4.90	VAPDSD0490	26.0	81.0	80	1.0	6	★
4.95	VAPDSD0495	26.0	81.0	80	1.0	6	★
5.00	VAPDSD0500	26.0	81.0	80	1.0	6	●
5.05	VAPDSD0505	26.1	81.1	80	1.1	6	★
5.10	VAPDSD0510	26.1	81.1	80	1.1	6	★
5.15	VAPDSD0515	26.1	81.1	80	1.1	6	★
5.20	VAPDSD0520	26.1	81.1	80	1.1	6	★
5.25	VAPDSD0525	26.1	81.1	80	1.1	6	★

DC (mm)	Bestellnummer	Abmessungen (mm)					Lager
		LCF	OAL	LF	PL	DCONMS	
5.30	VAPDSD0530	26.1	81.1	80	1.1	6	★
5.35	VAPDSD0535	28.1	81.1	80	1.1	6	★
5.40	VAPDSD0540	28.1	81.1	80	1.1	6	★
5.45	VAPDSD0545	28.1	81.1	80	1.1	6	★
5.50	VAPDSD0550	28.1	81.1	80	1.1	6	●
5.55	VAPDSD0555	28.2	81.2	80	1.2	6	★
5.60	VAPDSD0560	28.2	81.2	80	1.2	6	★
5.65	VAPDSD0565	28.2	81.2	80	1.2	6	★
5.70	VAPDSD0570	28.2	81.2	80	1.2	6	★
5.75	VAPDSD0575	28.2	81.2	80	1.2	6	★
5.80	VAPDSD0580	28.2	81.2	80	1.2	6	★
5.85	VAPDSD0585	28.2	81.2	80	1.2	6	★
5.90	VAPDSD0590	28.2	81.2	80	1.2	6	★
5.95	VAPDSD0595	28.2	81.2	80	1.2	6	★
6.00	VAPDSD0600	28.2	81.2	80	1.2	6	●
6.05	VAPDSD0605	31.3	81.3	80	1.3	8	★
6.10	VAPDSD0610	31.3	81.3	80	1.3	8	★
6.15	VAPDSD0615	31.3	81.3	80	1.3	8	★
6.20	VAPDSD0620	31.3	81.3	80	1.3	8	★
6.25	VAPDSD0625	31.3	81.3	80	1.3	8	★
6.30	VAPDSD0630	31.3	81.3	80	1.3	8	★
6.35	VAPDSD0635	31.3	81.3	80	1.3	8	★
6.40	VAPDSD0640	31.3	81.3	80	1.3	8	★
6.45	VAPDSD0645	31.3	81.3	80	1.3	8	★
6.50	VAPDSD0650	31.4	81.4	80	1.4	8	●
6.55	VAPDSD0655	31.4	81.4	80	1.4	8	★
6.60	VAPDSD0660	31.4	81.4	80	1.4	8	★
6.65	VAPDSD0665	31.4	81.4	80	1.4	8	★
6.70	VAPDSD0670	31.4	81.4	80	1.4	8	★
6.75	VAPDSD0675	33.4	81.4	80	1.4	8	★
6.80	VAPDSD0680	33.4	81.4	80	1.4	8	★
6.85	VAPDSD0685	33.4	81.4	80	1.4	8	★
6.90	VAPDSD0690	33.4	81.4	80	1.4	8	★
6.95	VAPDSD0695	33.4	81.4	80	1.4	8	★
7.00	VAPDSD0700	33.5	81.5	80	1.5	8	●
7.05	VAPDSD0705	33.5	81.5	80	1.5	8	★
7.10	VAPDSD0710	33.5	81.5	80	1.5	8	★
7.15	VAPDSD0715	33.5	81.5	80	1.5	8	★
7.20	VAPDSD0720	33.5	81.5	80	1.5	8	★
7.25	VAPDSD0725	33.5	81.5	80	1.5	8	★
7.30	VAPDSD0730	33.5	81.5	80	1.5	8	★
7.35	VAPDSD0735	33.5	81.5	80	1.5	8	★
7.40	VAPDSD0740	33.5	81.5	80	1.5	8	★
7.45	VAPDSD0745	33.5	81.5	80	1.5	8	★
7.50	VAPDSD0750	33.6	81.6	80	1.6	8	●
7.55	VAPDSD0755	36.6	86.6	85	1.6	8	★
7.60	VAPDSD0760	36.6	86.6	85	1.6	8	★
7.65	VAPDSD0765	36.6	86.6	85	1.6	8	★
7.70	VAPDSD0770	36.6	86.6	85	1.6	8	★
7.75	VAPDSD0775	36.6	86.6	85	1.6	8	★

● : Lagerstandard. ★ : Lagerstandard in Japan.

DC (mm)	Bestellnummer	Abmessungen (mm)					Lager
		LCF	OAL	LF	PL	DCONMS	
7.80	VAPDSD0780	36.6	86.6	85	1.6	8	★
7.85	VAPDSD0785	36.6	86.6	85	1.6	8	★
7.90	VAPDSD0790	36.6	86.6	85	1.6	8	★
7.95	VAPDSD0795	36.7	86.7	85	1.7	8	★
8.00	VAPDSD0800	36.7	86.7	85	1.7	8	●
8.05	VAPDSD0805	36.7	91.7	90	1.7	10	★
8.10	VAPDSD0810	36.7	91.7	90	1.7	10	★
8.15	VAPDSD0815	36.7	91.7	90	1.7	10	★
8.20	VAPDSD0820	36.7	91.7	90	1.7	10	★
8.25	VAPDSD0825	36.7	91.7	90	1.7	10	★
8.30	VAPDSD0830	36.7	91.7	90	1.7	10	★
8.35	VAPDSD0835	36.7	91.7	90	1.7	10	★
8.40	VAPDSD0840	36.7	91.7	90	1.7	10	★
8.45	VAPDSD0845	36.8	91.8	90	1.8	10	★
8.50	VAPDSD0850	36.8	91.8	90	1.8	10	●
8.55	VAPDSD0855	39.8	94.8	93	1.8	10	★
8.60	VAPDSD0860	39.8	94.8	93	1.8	10	★
8.65	VAPDSD0865	39.8	94.8	93	1.8	10	★
8.70	VAPDSD0870	39.8	94.8	93	1.8	10	★
8.75	VAPDSD0875	39.8	94.8	93	1.8	10	★
8.80	VAPDSD0880	39.8	94.8	93	1.8	10	★
8.85	VAPDSD0885	39.8	94.8	93	1.8	10	★
8.90	VAPDSD0890	39.8	94.8	93	1.8	10	★
8.95	VAPDSD0895	39.9	94.9	93	1.9	10	★
9.00	VAPDSD0900	39.9	94.9	93	1.9	10	●
9.10	VAPDSD0910	39.9	94.9	93	1.9	10	★
9.20	VAPDSD0920	39.9	94.9	93	1.9	10	★
9.30	VAPDSD0930	39.9	94.9	93	1.9	10	★
9.40	VAPDSD0940	40.0	95.0	93	2.0	10	★
9.50	VAPDSD0950	40.0	95.0	93	2.0	10	●
9.60	VAPDSD0960	43.0	98.0	96	2.0	10	★
9.70	VAPDSD0970	43.0	98.0	96	2.0	10	★
9.80	VAPDSD0980	43.0	98.0	96	2.0	10	★
9.90	VAPDSD0990	43.1	98.1	96	2.1	10	★
10.00	VAPDSD1000	43.1	98.1	96	2.1	10	●
10.10	VAPDSD1010	43.1	103.1	101	2.1	12	★
10.20	VAPDSD1020	43.1	103.1	101	2.1	12	★
10.30	VAPDSD1030	43.1	103.1	101	2.1	12	★
10.40	VAPDSD1040	43.2	103.2	101	2.2	12	★
10.50	VAPDSD1050	43.2	103.2	101	2.2	12	●
10.60	VAPDSD1060	43.2	103.2	101	2.2	12	★
10.70	VAPDSD1070	47.2	107.2	105	2.2	12	★
10.80	VAPDSD1080	47.2	107.2	105	2.2	12	★
10.90	VAPDSD1090	47.3	107.3	105	2.3	12	★
11.00	VAPDSD1100	47.3	107.3	105	2.3	12	●
11.10	VAPDSD1110	47.3	107.3	105	2.3	12	★
11.20	VAPDSD1120	47.3	107.3	105	2.3	12	★
11.30	VAPDSD1130	47.3	107.3	105	2.3	12	★
11.40	VAPDSD1140	47.4	107.4	105	2.4	12	★
11.50	VAPDSD1150	47.4	107.4	105	2.4	12	★

DC (mm)	Bestellnummer	Abmessungen (mm)					Lager
		LCF	OAL	LF	PL	DCONMS	
11.60	VAPDSD1160	47.4	107.4	105	2.4	12	★
11.70	VAPDSD1170	47.4	107.4	105	2.4	12	★
11.80	VAPDSD1180	47.4	107.4	105	2.4	12	★
11.90	VAPDSD1190	51.5	111.5	109	2.5	12	★
12.00	VAPDSD1200	51.5	111.5	109	2.5	12	●
12.10	VAPDSD1210	51.5	111.5	109	2.5	12	★
12.20	VAPDSD1220	51.5	111.5	109	2.5	12	★
12.30	VAPDSD1230	51.6	111.6	109	2.6	12	★
12.40	VAPDSD1240	51.6	111.6	109	2.6	12	★
12.50	VAPDSD1250	51.6	111.6	109	2.6	12	●
12.60	VAPDSD1260	51.6	111.6	109	2.6	12	★
12.70	VAPDSD1270	51.6	111.6	109	2.6	12	★
12.80	VAPDSD1280	51.7	111.7	109	2.7	12	★
12.90	VAPDSD1290	51.7	111.7	109	2.7	12	★
13.00	VAPDSD1300	51.7	111.7	109	2.7	12	★

M

BOHREN

## SCHNITTDATENEMPFEHLUNGEN

Material	P		P	K	P	M	P	M
	Baustahl		C-Stahl Ck55 Leg. Stahl Guss		Leg. Werkzeugstahl X210Cr12 (Materialien mit geringer Härte) Ferritisch rostfreier Stahl X10CrAl18, X10CrAl13 Martensitischer rostfreier Stahl X20Cr13, X10CrAl13		Leg. Werkzeugstahl X40CrMoV51 (-40HRC) Ausscheidungshärtung von rostfreiem Stahl X7CrNiAl177	
Bohrer Durchm. DC (mm)	Drehzahl (min <sup>-1</sup> )	Vorschub (mm/U.)	Drehzahl (min <sup>-1</sup> )	Vorschub (mm/U.)	Drehzahl (min <sup>-1</sup> )	Vorschub (mm/U.)	Drehzahl (min <sup>-1</sup> )	Vorschub (mm/U.)
<b>0.5</b>	18000	0.02	16000	0.02	9000	0.02	8200	0.02
<b>1.0</b>	12000	0.05	10000	0.05	6300	0.05	5500	0.04
<b>2.0</b>	6400	0.09	5500	0.09	3200	0.09	2900	0.05
<b>3.0</b>	4300	0.13	3700	0.13	2100	0.13	1900	0.06
<b>4.0</b>	3200	0.15	2800	0.15	1600	0.15	1400	0.08
<b>5.0</b>	2600	0.18	2200	0.18	1300	0.18	1100	0.10
<b>6.0</b>	2100	0.19	1800	0.19	1100	0.20	950	0.11
<b>8.0</b>	1600	0.24	1400	0.24	800	0.22	720	0.13
<b>10.0</b>	1300	0.28	1100	0.28	640	0.25	570	0.15
<b>12.0</b>	1100	0.34	930	0.34	530	0.30	480	0.17
<b>13.0</b>	980	0.36	860	0.36	490	0.32	440	0.19

Hinweis 1) Bitte passen Sie die Schnittwerte den Bedingungen des Werkstückes und der Maschine an.

Hinweis 2) Bitte setzen Sie Spannzangenfutter mit Präzisionshülsen ein.

Hinweis 3) Verwenden Sie genügend Kühlschmierstoff.

Hinweis 4) Bei Bohrungen über 4xDC empfehlen wir Vorschubunterbrechungen.

Hinweis 5) Bei Verwendung von wasserlöslicher Schmierflüssigkeit sind oben genannte Schnittdaten der Standard.

Bitte reduzieren Sie die Drehzahl bei Verwendung von nicht-wasserlöslichem Kühlschmierstoff.

**M**

BOHREN

# VAPDM

Mittlere Spirallänge



HSS

P M K N S H

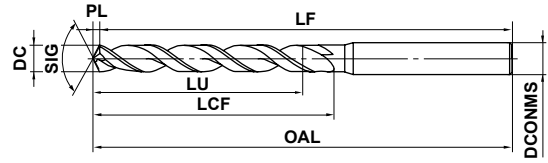

\*LU = LCF-2DC (Max 5×DC)



0.5 ≤ DC ≤ 3	3 < DC ≤ 6	6 < DC ≤ 10	10 < DC ≤ 18	18 < DC ≤ 30	30 < DC ≤ 32
0 -0.014	0 -0.018	0 -0.022	0 -0.027	0 -0.033	0 -0.039

● Mit der neu entwickelten Violet-Beschichtung wird eine noch höhere Effizienz und Standzeit erreicht.

DC (mm)	Bestellnummer	Abmessungen (mm)					Lager
		LCF	OAL	LF	PL	DCONMS	
0.50	VAPDMD0050	6.2	50.2	50	0.15	3	●
0.55	VAPDMD0055	6.2	50.2	50	0.17	3	★
0.60	VAPDMD0060	8.2	50.2	50	0.18	3	★
0.65	VAPDMD0065	8.2	50.2	50	0.20	3	★
0.70	VAPDMD0070	10.2	50.2	50	0.21	3	★
0.75	VAPDMD0075	10.2	50.2	50	0.23	3	★
0.80	VAPDMD0080	10.2	50.2	50	0.24	3	★
0.85	VAPDMD0085	10.3	50.3	50	0.26	3	★
0.90	VAPDMD0090	12.3	50.3	50	0.27	3	★
0.95	VAPDMD0095	12.3	50.3	50	0.29	3	★
1.00	VAPDMD0100	12.3	60.3	60	0.3	3	●
1.05	VAPDMD0105	12.3	60.3	60	0.3	3	★
1.10	VAPDMD0110	16.3	60.3	60	0.3	3	★
1.15	VAPDMD0115	16.4	60.4	60	0.4	3	★
1.20	VAPDMD0120	16.4	60.4	60	0.4	3	★
1.25	VAPDMD0125	16.4	60.4	60	0.4	3	★
1.30	VAPDMD0130	16.4	60.4	60	0.4	3	★
1.35	VAPDMD0135	18.4	60.4	60	0.4	3	★
1.40	VAPDMD0140	18.4	60.4	60	0.4	3	★
1.45	VAPDMD0145	18.4	60.4	60	0.4	3	★
1.50	VAPDMD0150	18.5	60.5	60	0.5	3	●
1.55	VAPDMD0155	20.5	60.5	60	0.5	3	★
1.60	VAPDMD0160	20.5	60.5	60	0.5	3	★
1.65	VAPDMD0165	20.5	60.5	60	0.5	3	★
1.70	VAPDMD0170	20.5	60.5	60	0.5	3	★
1.75	VAPDMD0175	20.5	60.5	60	0.5	3	★
1.80	VAPDMD0180	22.5	60.5	60	0.5	3	★
1.85	VAPDMD0185	22.6	60.6	60	0.6	3	★
1.90	VAPDMD0190	22.6	60.6	60	0.6	3	★
1.95	VAPDMD0195	23.6	60.6	60	0.6	3	★
2.00	VAPDMD0200	23.4	70.4	70	0.4	3	●
2.05	VAPDMD0205	23.4	70.4	70	0.4	3	★
2.10	VAPDMD0210	23.4	70.4	70	0.4	3	★

DC (mm)	Bestellnummer	Abmessungen (mm)					Lager
		LCF	OAL	LF	PL	DCONMS	
2.15	VAPDMD0215	23.5	70.5	70	0.5	3	★
2.20	VAPDMD0220	26.5	70.5	70	0.5	3	★
2.25	VAPDMD0225	26.5	70.5	70	0.5	3	★
2.30	VAPDMD0230	26.5	70.5	70	0.5	3	★
2.35	VAPDMD0235	26.5	70.5	70	0.5	3	★
2.40	VAPDMD0240	29.5	70.5	70	0.5	3	★
2.45	VAPDMD0245	29.5	70.5	70	0.5	3	★
2.50	VAPDMD0250	29.5	70.5	70	0.5	3	●
2.55	VAPDMD0255	29.5	70.5	70	0.5	3	★
2.60	VAPDMD0260	29.5	70.5	70	0.5	3	★
2.65	VAPDMD0265	29.6	70.6	70	0.6	3	★
2.70	VAPDMD0270	32.6	70.6	70	0.6	3	★
2.75	VAPDMD0275	32.6	70.6	70	0.6	3	★
2.80	VAPDMD0280	32.6	70.6	70	0.6	3	★
2.85	VAPDMD0285	32.6	70.6	70	0.6	3	★
2.90	VAPDMD0290	32.6	70.6	70	0.6	3	★
2.95	VAPDMD0295	32.6	70.6	70	0.6	3	★
3.00	VAPDMD0300	32.6	70.6	70	0.6	3	●
3.05	VAPDMD0305	35.6	85.6	85	0.6	4	★
3.10	VAPDMD0310	35.6	85.6	85	0.6	4	★
3.15	VAPDMD0315	35.7	85.7	85	0.7	4	★
3.20	VAPDMD0320	35.7	85.7	85	0.7	4	★
3.25	VAPDMD0325	35.7	85.7	85	0.7	4	★
3.30	VAPDMD0330	35.7	85.7	85	0.7	4	★
3.35	VAPDMD0335	35.7	85.7	85	0.7	4	★
3.40	VAPDMD0340	38.7	85.7	85	0.7	4	★
3.45	VAPDMD0345	38.7	85.7	85	0.7	4	★
3.50	VAPDMD0350	38.7	85.7	85	0.7	4	●
3.55	VAPDMD0355	38.7	85.7	85	0.7	4	★
3.60	VAPDMD0360	38.8	85.8	85	0.8	4	★
3.65	VAPDMD0365	38.8	85.8	85	0.8	4	★
3.70	VAPDMD0370	38.8	85.8	85	0.8	4	★
3.75	VAPDMD0375	42.8	85.8	85	0.8	4	★

● : Lagerstandard. ★ : Lagerstandard in Japan.

SCHNITTBEDINGUNGEN > M180  
TECHNISCHE DATEN > P001

M177

M  
BOHREN

# VIOLET BOHRER

## VAPDM

Mittlere Spirallänge

HSS

M  
BOHREN

DC (mm)	Bestellnummer	Abmessungen (mm)					Lager
		LCF	OAL	LF	PL	DCONMS	
3.80	VAPDMD0380	42.8	85.8	85	0.8	4	★
3.85	VAPDMD0385	42.8	85.8	85	0.8	4	★
3.90	VAPDMD0390	42.8	85.8	85	0.8	4	★
3.95	VAPDMD0395	42.8	85.8	85	0.8	4	★
4.00	VAPDMD0400	42.8	85.8	85	0.8	4	●
4.05	VAPDMD0405	42.8	100.8	100	0.8	6	★
4.10	VAPDMD0410	42.9	100.9	100	0.9	6	★
4.15	VAPDMD0415	42.9	100.9	100	0.9	6	★
4.20	VAPDMD0420	42.9	100.9	100	0.9	6	★
4.25	VAPDMD0425	46.9	100.9	100	0.9	6	★
4.30	VAPDMD0430	46.9	100.9	100	0.9	6	★
4.35	VAPDMD0435	46.9	100.9	100	0.9	6	★
4.40	VAPDMD0440	46.9	100.9	100	0.9	6	★
4.45	VAPDMD0445	46.9	100.9	100	0.9	6	★
4.50	VAPDMD0450	46.9	100.9	100	0.9	6	●
4.55	VAPDMD0455	46.9	100.9	100	0.9	6	★
4.60	VAPDMD0460	47.0	101.0	100	1.0	6	★
4.65	VAPDMD0465	47.0	101.0	100	1.0	6	★
4.70	VAPDMD0470	47.0	101.0	100	1.0	6	★
4.75	VAPDMD0475	47.0	101.0	100	1.0	6	★
4.80	VAPDMD0480	52.0	101.0	100	1.0	6	★
4.85	VAPDMD0485	52.0	101.0	100	1.0	6	★
4.90	VAPDMD0490	52.0	101.0	100	1.0	6	★
4.95	VAPDMD0495	52.0	101.0	100	1.0	6	★
5.00	VAPDMD0500	52.0	101.0	100	1.0	6	●
5.05	VAPDMD0505	52.1	101.1	100	1.1	6	★
5.10	VAPDMD0510	52.1	101.1	100	1.1	6	★
5.15	VAPDMD0515	52.1	101.1	100	1.1	6	★
5.20	VAPDMD0520	52.1	101.1	100	1.1	6	★
5.25	VAPDMD0525	52.1	101.1	100	1.1	6	★
5.30	VAPDMD0530	52.1	101.1	100	1.1	6	★
5.35	VAPDMD0535	57.1	107.1	106	1.1	6	★
5.40	VAPDMD0540	57.1	107.1	106	1.1	6	★
5.45	VAPDMD0545	57.1	107.1	106	1.1	6	★
5.50	VAPDMD0550	57.1	107.1	106	1.1	6	●
5.55	VAPDMD0555	57.2	107.2	106	1.2	6	★
5.60	VAPDMD0560	57.2	107.2	106	1.2	6	★
5.65	VAPDMD0565	57.2	107.2	106	1.2	6	★
5.70	VAPDMD0570	57.2	107.2	106	1.2	6	★
5.75	VAPDMD0575	57.2	107.2	106	1.2	6	★
5.80	VAPDMD0580	57.2	107.2	106	1.2	6	★
5.85	VAPDMD0585	57.2	107.2	106	1.2	6	★
5.90	VAPDMD0590	57.2	107.2	106	1.2	6	★
5.95	VAPDMD0595	57.2	107.2	106	1.2	6	★
6.00	VAPDMD0600	57.2	107.2	106	1.2	6	●
6.05	VAPDMD0605	63.3	113.3	112	1.3	8	★
6.10	VAPDMD0610	63.3	113.3	112	1.3	8	★
6.15	VAPDMD0615	63.3	113.3	112	1.3	8	★
6.20	VAPDMD0620	63.3	113.3	112	1.3	8	★
6.25	VAPDMD0625	63.3	113.3	112	1.3	8	★

DC (mm)	Bestellnummer	Abmessungen (mm)					Lager
		LCF	OAL	LF	PL	DCONMS	
6.30	VAPDMD0630	63.3	113.3	112	1.3	8	★
6.35	VAPDMD0635	63.3	113.3	112	1.3	8	★
6.40	VAPDMD0640	63.3	113.3	112	1.3	8	★
6.45	VAPDMD0645	63.3	113.3	112	1.3	8	★
6.50	VAPDMD0650	63.4	113.4	112	1.4	8	●
6.55	VAPDMD0655	63.4	113.4	112	1.4	8	★
6.60	VAPDMD0660	63.4	113.4	112	1.4	8	★
6.65	VAPDMD0665	63.4	113.4	112	1.4	8	★
6.70	VAPDMD0670	63.4	113.4	112	1.4	8	★
6.75	VAPDMD0675	68.4	118.4	117	1.4	8	★
6.80	VAPDMD0680	68.4	118.4	117	1.4	8	★
6.85	VAPDMD0685	68.4	118.4	117	1.4	8	★
6.90	VAPDMD0690	68.4	118.4	117	1.4	8	★
6.95	VAPDMD0695	68.4	118.4	117	1.4	8	★
7.00	VAPDMD0700	68.5	118.5	117	1.5	8	●
7.05	VAPDMD0705	68.5	118.5	117	1.5	8	★
7.10	VAPDMD0710	68.5	118.5	117	1.5	8	★
7.15	VAPDMD0715	68.5	118.5	117	1.5	8	★
7.20	VAPDMD0720	68.5	118.5	117	1.5	8	★
7.25	VAPDMD0725	68.5	118.5	117	1.5	8	★
7.30	VAPDMD0730	68.5	118.5	117	1.5	8	★
7.35	VAPDMD0735	68.5	118.5	117	1.5	8	★
7.40	VAPDMD0740	68.5	118.5	117	1.5	8	★
7.45	VAPDMD0745	68.5	118.5	117	1.5	8	★
7.50	VAPDMD0750	68.6	118.6	117	1.6	8	●
7.55	VAPDMD0755	74.6	124.6	123	1.6	8	★
7.60	VAPDMD0760	74.6	124.6	123	1.6	8	★
7.65	VAPDMD0765	74.6	124.6	123	1.6	8	★
7.70	VAPDMD0770	74.6	124.6	123	1.6	8	★
7.75	VAPDMD0775	74.6	124.6	123	1.6	8	★
7.80	VAPDMD0780	74.6	124.6	123	1.6	8	★
7.85	VAPDMD0785	74.6	124.6	123	1.6	8	★
7.90	VAPDMD0790	74.6	124.6	123	1.6	8	★
7.95	VAPDMD0795	74.7	124.7	123	1.7	8	★
8.00	VAPDMD0800	74.7	124.7	123	1.7	8	●
8.05	VAPDMD0805	74.7	129.7	128	1.7	10	★
8.10	VAPDMD0810	74.7	129.7	128	1.7	10	★
8.15	VAPDMD0815	74.7	129.7	128	1.7	10	★
8.20	VAPDMD0820	74.7	129.7	128	1.7	10	★
8.25	VAPDMD0825	74.7	129.7	128	1.7	10	★
8.30	VAPDMD0830	74.7	129.7	128	1.7	10	★
8.35	VAPDMD0835	74.7	129.7	128	1.7	10	★
8.40	VAPDMD0840	74.7	129.7	128	1.7	10	★
8.45	VAPDMD0845	74.8	129.8	128	1.8	10	★
8.50	VAPDMD0850	74.8	129.8	128	1.8	10	●
8.55	VAPDMD0855	80.8	135.8	134	1.8	10	★
8.60	VAPDMD0860	80.8	135.8	134	1.8	10	★
8.65	VAPDMD0865	80.8	135.8	134	1.8	10	★
8.70	VAPDMD0870	80.8	135.8	134	1.8	10	★
8.75	VAPDMD0875	80.8	135.8	134	1.8	10	★

● : Lagerstandard. ★ : Lagerstandard in Japan.



DC (mm)	Bestellnummer	Abmessungen (mm)					Lager
		LCF	OAL	LF	PL	DCONMS	
8.80	VAPDMD0880	80.8	135.8	134	1.8	10	★
8.85	VAPDMD0885	80.8	135.8	134	1.8	10	★
8.90	VAPDMD0890	80.8	135.8	134	1.8	10	★
8.95	VAPDMD0895	80.9	135.9	134	1.9	10	★
9.00	VAPDMD0900	80.9	135.9	134	1.9	10	●
9.10	VAPDMD0910	80.9	135.9	134	1.9	10	★
9.20	VAPDMD0920	80.9	135.9	134	1.9	10	★
9.30	VAPDMD0930	80.9	135.9	134	1.9	10	★
9.40	VAPDMD0940	81.0	136.0	134	2.0	10	★
9.50	VAPDMD0950	81.0	136.0	134	2.0	10	●
9.60	VAPDMD0960	87.0	142.0	140	2.0	10	★
9.70	VAPDMD0970	87.0	142.0	140	2.0	10	★
9.80	VAPDMD0980	87.0	142.0	140	2.0	10	★
9.90	VAPDMD0990	87.1	142.1	140	2.1	10	★
10.00	VAPDMD1000	87.1	142.1	140	2.1	10	●
10.10	VAPDMD1010	87.1	147.1	145	2.1	12	★
10.20	VAPDMD1020	87.1	147.1	145	2.1	12	★
10.30	VAPDMD1030	87.1	147.1	145	2.1	12	★
10.40	VAPDMD1040	87.2	147.2	145	2.2	12	★
10.50	VAPDMD1050	87.2	147.2	145	2.2	12	●
10.60	VAPDMD1060	87.2	147.2	145	2.2	12	★
10.70	VAPDMD1070	94.2	154.2	152	2.2	12	★
10.80	VAPDMD1080	94.2	154.2	152	2.2	12	★
10.90	VAPDMD1090	94.3	154.3	152	2.3	12	★
11.00	VAPDMD1100	94.3	154.3	152	2.3	12	●
11.10	VAPDMD1110	94.3	154.3	152	2.3	12	★
11.20	VAPDMD1120	94.3	154.3	152	2.3	12	★
11.30	VAPDMD1130	94.3	154.3	152	2.3	12	★
11.40	VAPDMD1140	94.4	154.4	152	2.4	12	★
11.50	VAPDMD1150	94.4	154.4	152	2.4	12	●
11.60	VAPDMD1160	94.4	154.4	152	2.4	12	★
11.70	VAPDMD1170	94.4	154.4	152	2.4	12	★
11.80	VAPDMD1180	94.4	154.4	152	2.4	12	★
11.90	VAPDMD1190	101.5	161.5	159	2.5	12	★
12.00	VAPDMD1200	101.5	161.5	159	2.5	12	●
12.10	VAPDMD1210	101.5	161.5	159	2.5	12	★
12.20	VAPDMD1220	101.5	161.5	159	2.5	12	★
12.30	VAPDMD1230	101.6	161.6	159	2.6	12	★
12.40	VAPDMD1240	101.6	161.6	159	2.6	12	★
12.50	VAPDMD1250	101.6	161.6	159	2.6	12	●
12.60	VAPDMD1260	101.6	161.6	159	2.6	12	★
12.70	VAPDMD1270	101.6	161.6	159	2.6	12	★
12.80	VAPDMD1280	101.7	161.7	159	2.7	12	★
12.90	VAPDMD1290	101.7	161.7	159	2.7	12	★
13.00	VAPDMD1300	101.7	161.7	159	2.7	12	●
13.50	VAPDMD1350	102.8	162.8	160	2.8	16	●
14.00	VAPDMD1400	102.9	162.9	160	2.9	16	●
14.10	VAPDMD1410	107.9	167.9	165	2.9	16	★
14.20	VAPDMD1420	107.9	167.9	165	2.9	16	★
14.50	VAPDMD1450	108.0	168.0	165	3.0	16	●
15.00	VAPDMD1500	108.1	168.1	165	3.1	16	●

DC (mm)	Bestellnummer	Abmessungen (mm)					Lager
		LCF	OAL	LF	PL	DCONMS	
15.50	VAPDMD1550	113.2	173.2	170	3.2	16	★
15.60	VAPDMD1560	113.2	173.2	170	3.2	16	★
15.70	VAPDMD1570	113.3	173.3	170	3.3	16	★
16.00	VAPDMD1600	113.3	173.3	170	3.3	16	●
16.50	VAPDMD1650	113.4	178.4	175	3.4	20	●
17.00	VAPDMD1700	113.5	178.5	175	3.5	20	●
17.50	VAPDMD1750	118.6	183.6	180	3.6	20	●
17.60	VAPDMD1760	118.7	183.7	180	3.7	20	★
17.70	VAPDMD1770	118.7	183.7	180	3.7	20	★
18.00	VAPDMD1800	118.7	183.7	180	3.7	20	●
18.50	VAPDMD1850	123.8	188.8	185	3.8	20	★
19.00	VAPDMD1900	123.9	188.9	185	3.9	20	★
19.50	VAPDMD1950	124.0	189.0	185	4.0	20	★
19.60	VAPDMD1960	124.1	189.1	185	4.1	20	★
19.70	VAPDMD1970	124.1	189.1	185	4.1	20	★
20.00	VAPDMD2000	124.1	189.1	185	4.1	20	★
20.50	VAPDMD2050	129.3	204.3	200	4.3	25	●
21.00	VAPDMD2100	129.4	204.4	200	4.4	25	●
21.10	VAPDMD2110	129.4	204.4	200	4.4	25	★
21.20	VAPDMD2120	129.4	204.4	200	4.4	25	★
21.50	VAPDMD2150	129.5	204.5	200	4.5	25	★
22.00	VAPDMD2200	129.6	204.6	200	4.6	25	●
22.50	VAPDMD2250	134.7	209.7	205	4.7	25	★
23.00	VAPDMD2300	134.8	209.8	205	4.8	25	●
23.50	VAPDMD2350	134.9	209.9	205	4.9	25	★
24.00	VAPDMD2400	140.0	215.0	210	5.0	25	★
24.50	VAPDMD2450	140.1	215.1	210	5.1	25	★
25.00	VAPDMD2500	140.2	215.2	210	5.2	25	★
25.50	VAPDMD2550	145.3	225.3	220	5.3	32	●
26.00	VAPDMD2600	145.4	225.4	220	5.4	32	★
26.50	VAPDMD2650	145.5	225.5	220	5.5	32	★
27.00	VAPDMD2700	145.6	225.6	220	5.6	32	★
28.00	VAPDMD2800	145.8	225.8	220	5.8	32	★
29.00	VAPDMD2900	151.0	231.0	225	6.0	32	★
30.00	VAPDMD3000	151.2	231.2	225	6.2	32	★
31.00	VAPDMD3100	156.4	236.4	230	6.4	32	★
32.00	VAPDMD3200	161.6	241.6	235	6.6	32	★

M

BOHREN

## SCHNITTDATENEMPFEHLUNGEN (Standard Bohrtiefe: 5 x D oder weniger)

Material	P		P	K	P	M	P	M
	Baustahl		C-Stahl Ck55 Leg. Stahl Guss		Leg. Werkzeugstahl X210Cr12 (Materialien mit geringer Härte) Ferritisch rostfreier Stahl X10CrAl18, X10CrAl13 Martensitischer rostfreier Stahl X20Cr13, X10CrAl13		Leg. Werkzeugstahl X40CrMoV51 (-40HRC) Ausscheidungshärtung von rostfreiem Stahl X7CrNiAl177	
Bohrer Durchm. DC (mm)	Drehzahl (min <sup>-1</sup> )	Vorschub (mm/U.)	Drehzahl (min <sup>-1</sup> )	Vorschub (mm/U.)	Drehzahl (min <sup>-1</sup> )	Vorschub (mm/U.)	Drehzahl (min <sup>-1</sup> )	Vorschub (mm/U.)
<b>0.5</b>	17000	0.01	12800	0.01	8000	0.01	6600	0.01
<b>1.0</b>	11000	0.05	8300	0.05	5000	0.05	4100	0.04
<b>2.0</b>	6400	0.09	4800	0.09	2900	0.06	2400	0.05
<b>3.0</b>	4300	0.13	3200	0.13	1900	0.10	1600	0.06
<b>4.0</b>	3200	0.15	2400	0.15	1400	0.10	1200	0.08
<b>5.0</b>	2600	0.18	1900	0.18	1100	0.13	950	0.10
<b>6.0</b>	2100	0.19	1600	0.20	950	0.15	800	0.11
<b>8.0</b>	1600	0.24	1200	0.22	720	0.18	600	0.13
<b>10.0</b>	1300	0.28	950	0.25	570	0.21	480	0.15
<b>12.0</b>	1100	0.34	800	0.30	480	0.25	400	0.17
<b>14.0</b>	910	0.39	680	0.35	410	0.30	340	0.21
<b>15.0</b>	850	0.40	640	0.36	380	0.31	320	0.22
<b>16.0</b>	800	0.42	600	0.38	360	0.32	300	0.23
<b>18.0</b>	710	0.44	530	0.40	320	0.34	270	0.24
<b>20.0</b>	570	0.44	450	0.40	250	0.34	220	0.24
<b>22.0</b>	520	0.46	410	0.42	230	0.36	200	0.25
<b>24.0</b>	480	0.48	370	0.44	210	0.37	190	0.26
<b>26.0</b>	440	0.51	340	0.46	200	0.39	170	0.28
<b>28.0</b>	410	0.53	320	0.48	180	0.41	160	0.29
<b>30.0</b>	380	0.55	300	0.50	170	0.43	150	0.30
<b>32.0</b>	360	0.55	280	0.50	160	0.43	140	0.30

Hinweis 1) Bitte passen Sie die Schnittwerte den Bedingungen des Werkstückes und der Maschine an.

Hinweis 2) Bitte setzen Sie Spannzangenfutter mit Präzisionshülsen ein.

Hinweis 3) Verwenden Sie genügend Kühlschmierstoff.

Hinweis 4) Bei Bohrungen über 4xDC empfehlen wir Vorschubunterbrechungen.

Hinweis 5) Bei Verwendung von wasserlöslicher Schmierflüssigkeit sind oben genannte Schnittdaten der Standard.  
Bitte reduzieren Sie die Drehzahl bei Verwendung von nicht-wasserlöslichem Kühlschmierstoff.

# VSD

Zylindrischer Schaft



HSS

P M K N S H

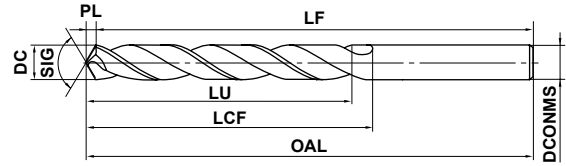

\*LU = LCF - 2DC



0.5 ≤ DC ≤ 1	1 ≤ DC ≤ 3	3 < DC ≤ 6	6 < DC ≤ 10	10 < DC ≤ 13
0 -0.010	0 -0.014	0 -0.018	0 -0.022	0 -0.027

DC (mm)	Bestellnummer	Abmessungen (mm)					Lager
		LCF	OAL	LF	PL	DCONMS	
0.5	VSDD0050	6.2	27.2	27	0.18	0.5	★
0.6	VSDD0060	7.2	30.2	30	0.21	0.6	●
0.7	VSDD0070	9.2	32.2	32	0.21	0.7	●
0.8	VSDD0080	10.2	34.2	34	0.24	0.8	●
0.9	VSDD0090	11.3	36.3	36	0.27	0.9	●
1.0	VSDD0100	12.3	40.3	40	0.3	1.0	●
1.1	VSDD0110	14.3	42.3	42	0.3	1.1	●
1.2	VSDD0120	16.4	42.4	42	0.4	1.2	●
1.3	VSDD0130	16.4	45.4	45	0.4	1.3	●
1.4	VSDD0140	18.4	48.4	48	0.4	1.4	●
1.5	VSDD0150	18.5	48.5	48	0.5	1.5	●
1.6	VSDD0160	20.5	50.5	50	0.5	1.6	●
1.7	VSDD0170	20.5	50.5	50	0.5	1.7	★
1.8	VSDD0180	22.5	52.5	52	0.5	1.8	●
1.9	VSDD0190	22.6	52.6	52	0.6	1.9	●
2.0	VSDD0200	23.6	55.6	55	0.6	2.0	●
2.1	VSDD0210	23.6	55.6	55	0.6	2.1	●
2.2	VSDD0220	26.7	58.7	58	0.7	2.2	●
2.3	VSDD0230	26.7	58.7	58	0.7	2.3	★
2.4	VSDD0240	29.7	61.7	61	0.7	2.4	★
2.5	VSDD0250	29.8	61.8	61	0.8	2.5	●
2.6	VSDD0260	29.8	64.8	64	0.8	2.6	★
2.7	VSDD0270	32.8	64.8	64	0.8	2.7	★
2.8	VSDD0280	32.8	67.8	67	0.8	2.8	●
2.9	VSDD0290	32.9	71.9	71	0.9	2.9	★
3.0	VSDD0300	32.9	71.9	71	0.9	3.0	●
3.1	VSDD0310	35.9	71.9	71	0.9	3.1	●
3.2	VSDD0320	36.0	72.0	71	1.0	3.2	●
3.3	VSDD0330	36.0	74.0	73	1.0	3.3	●
3.4	VSDD0340	39.0	74.0	73	1.0	3.4	●
3.5	VSDD0350	39.1	74.1	73	1.1	3.5	●
3.6	VSDD0360	39.1	77.1	76	1.1	3.6	★
3.7	VSDD0370	39.1	77.1	76	1.1	3.7	★
3.8	VSDD0380	43.1	77.1	76	1.1	3.8	★
3.9	VSDD0390	43.2	80.2	79	1.2	3.9	★
4.0	VSDD0400	43.2	84.2	83	1.2	4.0	●
4.1	VSDD0410	43.2	84.2	83	1.2	4.1	●
4.2	VSDD0420	43.3	84.3	83	1.3	4.2	●
4.3	VSDD0430	47.3	84.3	83	1.3	4.3	●
4.4	VSDD0440	47.3	87.3	86	1.3	4.4	★

DC (mm)	Bestellnummer	Abmessungen (mm)					Lager
		LCF	OAL	LF	PL	DCONMS	
4.5	VSDD0450	47.4	87.4	86	1.4	4.5	●
4.6	VSDD0460	47.4	87.4	86	1.4	4.6	★
4.7	VSDD0470	47.4	90.4	89	1.4	4.7	★
4.8	VSDD0480	52.4	90.4	89	1.4	4.8	●
4.9	VSDD0490	52.5	93.5	92	1.5	4.9	★
5.0	VSDD0500	52.5	93.5	92	1.5	5.0	●
5.1	VSDD0510	52.5	93.5	92	1.5	5.1	●
5.2	VSDD0520	52.6	96.6	95	1.6	5.2	●
5.3	VSDD0530	52.6	96.6	95	1.6	5.3	★
5.4	VSDD0540	57.6	96.6	95	1.6	5.4	★
5.5	VSDD0550	57.7	96.7	95	1.7	5.5	●
5.6	VSDD0560	57.7	99.7	98	1.7	5.6	★
5.7	VSDD0570	57.7	99.7	98	1.7	5.7	★
5.8	VSDD0580	57.7	99.7	98	1.7	5.8	★
5.9	VSDD0590	57.8	99.8	98	1.8	5.9	●
6.0	VSDD0600	57.8	103.8	102	1.8	6.0	●
6.1	VSDD0610	63.8	103.8	102	1.8	6.1	★
6.2	VSDD0620	63.9	103.9	102	1.9	6.2	●
6.3	VSDD0630	63.9	103.9	102	1.9	6.3	●
6.4	VSDD0640	63.9	106.9	105	1.9	6.4	★
6.5	VSDD0650	64.0	107.0	105	2.0	6.5	●
6.6	VSDD0660	64.0	107.0	105	2.0	6.6	★
6.7	VSDD0670	64.0	107.0	105	2.0	6.7	★
6.8	VSDD0680	69.0	107.0	105	2.0	6.8	●
6.9	VSDD0690	69.1	107.1	105	2.1	6.9	★
7.0	VSDD0700	69.1	107.1	105	2.1	7.0	●
7.1	VSDD0710	69.1	110.1	108	2.1	7.1	★
7.2	VSDD0720	69.2	110.2	108	2.2	7.2	★
7.3	VSDD0730	69.2	110.2	108	2.2	7.3	●
7.4	VSDD0740	69.2	113.2	111	2.2	7.4	★
7.5	VSDD0750	69.3	113.3	111	2.3	7.5	★
7.6	VSDD0760	75.3	113.3	111	2.3	7.6	★
7.7	VSDD0770	75.3	116.3	114	2.3	7.7	★
7.8	VSDD0780	75.3	116.3	114	2.3	7.8	★
7.9	VSDD0790	75.4	116.4	114	2.4	7.9	●
8.0	VSDD0800	75.4	116.4	114	2.4	8.0	●
8.1	VSDD0810	75.4	119.4	117	2.4	8.1	★
8.2	VSDD0820	75.5	119.5	117	2.5	8.2	★
8.3	VSDD0830	75.5	119.5	117	2.5	8.3	★
8.4	VSDD0840	75.5	123.5	121	2.5	8.4	★

Hinweis 1) Kleiner als Ø5-Ø1,9 mm: 5 Stück/VPE, größer als Ø2 mm: 1 Stück/VPE.

● : Lagerstandard. ★ : Lagerstandard in Japan.

SCHNITTBEDINGUNGEN > M182  
TECHNISCHE DATEN > P001

M181

M  
BOHREN

# VIOLET BOHRER

## VSD

Zylindrischer Schaft

HSS

M  
BOHREN

DC (mm)	Bestellnummer	Abmessungen (mm)					Lager
		LCF	OAL	LF	PL	DCONMS	
8.5	VSDD0850	75.6	123.6	121	2.6	8.5	●
8.6	VSDD0860	81.6	123.6	121	2.6	8.6	●
8.7	VSDD0870	81.6	123.6	121	2.6	8.7	●
8.8	VSDD0880	81.6	126.6	124	2.6	8.8	★
8.9	VSDD0890	81.7	126.7	124	2.7	8.9	★
9.0	VSDD0900	81.7	126.7	124	2.7	9.0	●
9.1	VSDD0910	81.7	126.7	124	2.7	9.1	★
9.2	VSDD0920	81.8	129.8	127	2.8	9.2	★
9.3	VSDD0930	81.8	129.8	127	2.8	9.3	★
9.4	VSDD0940	81.8	129.8	127	2.8	9.4	★
9.5	VSDD0950	81.9	129.9	127	2.9	9.5	●
9.6	VSDD0960	87.9	132.9	130	2.9	9.6	★
9.7	VSDD0970	87.9	132.9	130	2.9	9.7	★
9.8	VSDD0980	87.9	132.9	130	2.9	9.8	★
9.9	VSDD0990	88.0	133.0	130	3.0	9.9	★
10.0	VSDD1000	88.0	133.0	130	3.0	10.0	●
10.1	VSDD1010	88.0	136.0	133	3.0	10.1	★
10.2	VSDD1020	88.1	136.1	133	3.1	10.2	●
10.3	VSDD1030	88.1	136.1	133	3.1	10.3	●
10.4	VSDD1040	88.1	136.1	133	3.1	10.4	★
10.5	VSDD1050	88.2	140.2	137	3.2	10.5	●
10.6	VSDD1060	88.2	140.2	137	3.2	10.6	★
10.7	VSDD1070	95.2	140.2	137	3.2	10.7	★

DC (mm)	Bestellnummer	Abmessungen (mm)					Lager
		LCF	OAL	LF	PL	DCONMS	
10.8	VSDD1080	95.2	143.2	140	3.2	10.8	★
10.9	VSDD1090	95.3	143.3	140	3.3	10.9	★
11.0	VSDD1100	95.3	143.3	140	3.3	11.0	●
11.1	VSDD1110	95.3	143.3	140	3.3	11.1	★
11.2	VSDD1120	95.4	146.4	143	3.4	11.2	★
11.3	VSDD1130	95.4	146.4	143	3.4	11.3	★
11.4	VSDD1140	95.4	146.4	143	3.4	11.4	★
11.5	VSDD1150	95.5	146.5	143	3.5	11.5	★
11.6	VSDD1160	95.5	149.5	146	3.5	11.6	★
11.7	VSDD1170	95.5	149.5	146	3.5	11.7	★
11.8	VSDD1180	95.5	149.5	146	3.5	11.8	★
11.9	VSDD1190	102.6	149.6	146	3.6	11.9	★
12.0	VSDD1200	102.6	152.6	149	3.6	12.0	●
12.1	VSDD1210	102.6	152.6	149	3.6	12.1	★
12.2	VSDD1220	102.7	152.7	149	3.7	12.2	★
12.3	VSDD1230	102.7	152.7	149	3.7	12.3	★
12.4	VSDD1240	102.7	155.7	152	3.7	12.4	★
12.5	VSDD1250	102.8	155.8	152	3.8	12.5	★
12.6	VSDD1260	102.8	155.8	152	3.8	12.6	★
12.7	VSDD1270	102.8	155.8	152	3.8	12.7	★
12.8	VSDD1280	102.8	155.8	152	3.8	12.8	★
12.9	VSDD1290	102.9	155.9	152	3.9	12.9	★
13.0	VSDD1300	102.9	155.9	152	3.9	13.0	●

## SCHNITTDATENEMPFEHLUNGEN

Material	P		M		P		M	
	Baustahl	C-Stahl Ck55	Rostfreier Stahl X20Cr13		Rostfreier Stahl X5CrNi1810 Werkzeugstahl X210Cr12 (Materialien mit geringer Härte) Vergüteter Stahl X40CrMoV51 (-40HRC)			
Schnittgeschw.	40m/min		30m/min		20m/min		10-14m/min	
Bohrer Durchm. DC (mm)	Drehzahl (min <sup>-1</sup> )	Vorschub (mm/U.)	Drehzahl (min <sup>-1</sup> )	Vorschub (mm/U.)	Drehzahl (min <sup>-1</sup> )	Vorschub (mm/U.)	Drehzahl (min <sup>-1</sup> )	Vorschub (mm/U.)
0.5	15000	0.01	11250	0.01	7500	0.01	5620	0.01
1.0	10000	0.02	7500	0.02	5000	0.02	3750	0.02
1.5	8200	0.03	6150	0.03	4100	0.03	2800	0.03
2.0	6370	0.05	4780	0.05	3180	0.05	2200	0.04
3.0	4250	0.10	3180	0.10	2120	0.07	1400	0.06
4.0	3180	0.13	2390	0.13	1590	0.09	1100	0.08
5.0	2550	0.15	1910	0.15	1270	0.11	860	0.10
6.0	2120	0.18	1590	0.18	1060	0.13	720	0.11
7.0	1820	0.20	1360	0.20	910	0.14	610	0.12
8.0	1590	0.22	1190	0.21	800	0.15	540	0.13
9.0	1420	0.24	1060	0.22	710	0.17	480	0.14
10.0	1270	0.26	960	0.23	640	0.18	430	0.15
11.0	1160	0.28	870	0.24	580	0.19	390	0.16
12.0	1060	0.30	800	0.25	530	0.20	360	0.17
13.0	980	0.30	730	0.26	490	0.20	330	0.17

Hinweis 1) Bitte passen Sie die Schnittwerte den Bedingungen des Werkstückes und der Maschine an.

Hinweis 2) Bei Verwendung von wasserlöslicher Schmierflüssigkeit sind oben genannte Schnittdaten der Standard.

Bitte reduzieren Sie die Drehzahl bei Verwendung von nicht-wasserlöslichem Kühlschmierstoff.

● : Lagerstandard. ★ : Lagerstandard in Japan.

# VAPDSCB

Kurze Schneidlänge, hohe Präzision, mit Zentrumschneide, für das Anbohren



HSS

P M K N S H

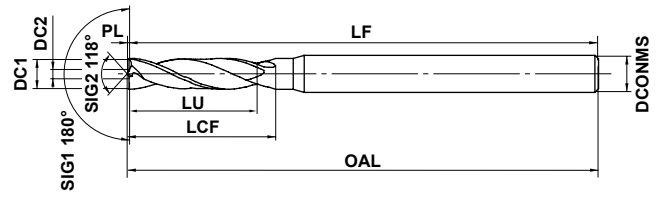

\*LU = LCF - 2DC (Max 3×DC)



DC ≤ 3	3 < DC ≤ 6	6 < DC ≤ 10	10 < DC ≤ 18	18 < DC ≤ 30	30 < DC ≤ 32
0	0	0	0	0	0
-0.014	-0.018	-0.022	-0.027	-0.033	-0.039

- Die einzigartige Geometrie ermöglicht hocheffizientes Anbohren. Ausgezeichnete Spanbrechung und flacher Boden der gegeborenen Oberfläche.

DC1 (mm)	Bestellnummer	Abmessungen (mm)						Lager
		DC2	LCF	OAL	LF	PL	DCONMS	
2.0	VAPDSCBD0200	0.7	12	60.2	60	0.2	3	★
2.1	VAPDSCBD0210	0.7	12	60.2	60	0.2	3	★
2.2	VAPDSCBD0220	0.7	12	60.2	60	0.2	3	★
2.3	VAPDSCBD0230	0.7	13	60.2	60	0.2	3	★
2.4	VAPDSCBD0240	0.7	13	60.2	60	0.2	3	★
2.5	VAPDSCBD0250	0.7	13	60.2	60	0.2	3	★
2.6	VAPDSCBD0260	0.8	15	60.2	60	0.2	3	★
2.7	VAPDSCBD0270	0.8	15	60.2	60	0.2	3	★
2.8	VAPDSCBD0280	0.8	15	60.2	60	0.2	3	★
2.9	VAPDSCBD0290	0.8	15	60.2	60	0.2	3	★
3.0	VAPDSCBD0300	0.8	15	60.2	60	0.2	3	★
3.1	VAPDSCBD0310	0.8	17	70.2	70	0.2	4	★
3.2	VAPDSCBD0320	0.8	17	70.2	70	0.2	4	★
3.3	VAPDSCBD0330	0.8	19	70.2	70	0.2	4	★
3.4	VAPDSCBD0340	0.8	19	70.2	70	0.2	4	★
3.5	VAPDSCBD0350	0.8	19	70.2	70	0.2	4	★
3.6	VAPDSCBD0360	1.0	21	70.2	70	0.2	4	★
3.7	VAPDSCBD0370	1.0	21	70.2	70	0.2	4	★
3.8	VAPDSCBD0380	1.0	21	70.2	70	0.2	4	★
3.9	VAPDSCBD0390	1.0	21	70.2	70	0.2	4	★
4.0	VAPDSCBD0400	1.0	21	70.3	70	0.3	4	★
4.1	VAPDSCBD0410	1.0	21	80.3	80	0.3	6	★
4.2	VAPDSCBD0420	1.0	21	80.3	80	0.3	6	★
4.3	VAPDSCBD0430	1.0	23	80.3	80	0.3	6	★
4.4	VAPDSCBD0440	1.0	23	80.3	80	0.3	6	★
4.5	VAPDSCBD0450	1.0	23	80.3	80	0.3	6	★
4.6	VAPDSCBD0460	1.4	25	80.3	80	0.3	6	★
4.7	VAPDSCBD0470	1.4	25	80.3	80	0.3	6	★
4.8	VAPDSCBD0480	1.4	25	80.3	80	0.3	6	★
4.9	VAPDSCBD0490	1.4	25	80.3	80	0.3	6	★
5.0	VAPDSCBD0500	1.4	25	80.4	80	0.4	6	★
5.1	VAPDSCBD0510	1.4	25	80.4	80	0.4	6	★
5.2	VAPDSCBD0520	1.4	25	80.4	80	0.4	6	★
5.3	VAPDSCBD0530	1.4	25	80.4	80	0.4	6	★
5.4	VAPDSCBD0540	1.4	27	80.4	80	0.4	6	★
5.5	VAPDSCBD0550	1.4	27	80.4	80	0.4	6	★
5.6	VAPDSCBD0560	1.4	27	80.4	80	0.4	6	★
5.7	VAPDSCBD0570	1.4	27	80.4	80	0.4	6	★
5.8	VAPDSCBD0580	1.4	27	80.4	80	0.4	6	★
5.9	VAPDSCBD0590	1.4	27	80.4	80	0.4	6	★

DC1 (mm)	Bestellnummer	Abmessungen (mm)						Lager
		DC2	LCF	OAL	LF	PL	DCONMS	
6.0	VAPDSCBD0600	1.4	27	80.4	80	0.4	6	★
6.1	VAPDSCBD0610	1.4	30	80.4	80	0.4	8	★
6.2	VAPDSCBD0620	1.4	30	80.4	80	0.4	8	★
6.3	VAPDSCBD0630	1.4	30	80.4	80	0.4	8	★
6.4	VAPDSCBD0640	1.4	30	80.4	80	0.4	8	★
6.5	VAPDSCBD0650	1.4	30	80.4	80	0.4	8	★
6.6	VAPDSCBD0660	1.8	30	80.4	80	0.4	8	★
6.7	VAPDSCBD0670	1.8	30	80.4	80	0.4	8	★
6.8	VAPDSCBD0680	1.8	32	80.4	80	0.4	8	★
6.9	VAPDSCBD0690	1.8	32	80.4	80	0.4	8	★
7.0	VAPDSCBD0700	1.8	32	80.6	80	0.6	8	★
7.1	VAPDSCBD0710	1.8	32	80.6	80	0.6	8	★
7.2	VAPDSCBD0720	1.8	32	80.6	80	0.6	8	★
7.3	VAPDSCBD0730	1.8	32	80.6	80	0.6	8	★
7.4	VAPDSCBD0740	1.8	32	80.6	80	0.6	8	★
7.5	VAPDSCBD0750	1.8	32	80.6	80	0.6	8	★
7.6	VAPDSCBD0760	2.0	35	85.6	85	0.6	8	★
7.7	VAPDSCBD0770	2.0	35	85.6	85	0.6	8	★
7.8	VAPDSCBD0780	2.0	35	85.6	85	0.6	8	★
7.9	VAPDSCBD0790	2.0	35	85.6	85	0.6	8	★
8.0	VAPDSCBD0800	2.0	35	85.6	85	0.6	8	★
8.1	VAPDSCBD0810	2.0	35	90.6	90	0.6	10	★
8.5	VAPDSCBD0850	2.0	35	90.6	90	0.6	10	★
8.6	VAPDSCBD0860	2.8	38	93.6	93	0.6	10	★
8.8	VAPDSCBD0880	2.8	38	93.6	93	0.6	10	★
9.0	VAPDSCBD0900	2.8	38	93.8	93	0.8	10	★
9.1	VAPDSCBD0910	2.8	38	93.8	93	0.8	10	★
9.5	VAPDSCBD0950	2.8	38	93.8	93	0.8	10	★
9.6	VAPDSCBD0960	3.2	41	96.8	96	0.8	10	★
9.8	VAPDSCBD0980	3.2	41	96.8	96	0.8	10	★
10.0	VAPDSCBD1000	3.2	41	96.9	96	0.9	10	★
10.1	VAPDSCBD1010	3.2	41	101.9	101	0.9	12	★
10.3	VAPDSCBD1030	3.2	41	101.9	101	0.9	12	★
10.5	VAPDSCBD1050	3.2	41	101.9	101	0.9	12	★
10.8	VAPDSCBD1080	3.7	45	105.9	105	0.9	12	★
11.0	VAPDSCBD1100	3.7	45	105.9	105	0.9	12	★
11.1	VAPDSCBD1110	3.7	45	105.9	105	0.9	12	★
11.5	VAPDSCBD1150	3.7	45	105.9	105	0.9	12	★
11.8	VAPDSCBD1180	3.7	45	105.9	105	0.9	12	★
12.0	VAPDSCBD1200	3.7	49	109.9	109	0.9	12	★

M  
BOHREN

# VIOLET BOHRER

HSS

## VAPDSCB

Kurze Schneidlänge, hohe Präzision, mit Zentrumschneidspitze, für das Anbohren

M

BOHREN

DC1 (mm)	Bestellnummer	Abmessungen (mm)						Lager
		DC2	LCF	OAL	LF	PL	DCOMMS	
12.5	VAPDSCBD1250	3.7	49	109.9	109	0.9	12	★
13.0	VAPDSCBD1300	4.2	49	110.1	109	1.1	12	★
13.5	VAPDSCBD1350	4.2	51	122.1	121	1.1	16	★
13.8	VAPDSCBD1380	4.2	51	122.1	121	1.1	16	★
14.0	VAPDSCBD1400	4.2	51	122.1	121	1.1	16	★
14.1	VAPDSCBD1410	5.5	58	124.1	123	1.1	16	★
14.2	VAPDSCBD1420	5.5	58	124.1	123	1.1	16	★
14.5	VAPDSCBD1450	5.5	58	124.1	123	1.1	16	★
14.8	VAPDSCBD1480	5.5	58	124.1	123	1.1	16	★
15.0	VAPDSCBD1500	5.5	58	124.3	123	1.3	16	★
15.5	VAPDSCBD1550	5.5	60	126.3	125	1.3	16	★
15.7	VAPDSCBD1570	5.5	60	126.3	125	1.3	16	★
15.8	VAPDSCBD1580	5.5	60	126.3	125	1.3	16	★
16.0	VAPDSCBD1600	5.5	60	126.3	125	1.3	16	★
17.0	VAPDSCBD1700	5.5	62	133.3	132	1.3	20	★
17.5	VAPDSCBD1750	5.5	63	134.6	133	1.6	20	★
17.6	VAPDSCBD1760	6.5	63	134.6	133	1.6	20	★
17.7	VAPDSCBD1770	6.5	63	134.6	133	1.6	20	★
17.8	VAPDSCBD1780	6.5	63	134.6	133	1.6	20	★
18.0	VAPDSCBD1800	6.5	63	134.6	133	1.6	20	★
18.1	VAPDSCBD1810	6.5	65	136.6	135	1.6	20	★
19.0	VAPDSCBD1900	6.5	65	136.6	135	1.6	20	★
19.8	VAPDSCBD1980	7.5	67	138.6	137	1.6	20	★
20.0	VAPDSCBD2000	7.5	67	138.8	137	1.8	20	★
20.1	VAPDSCBD2010	7.5	67	138.8	137	1.8	20	★
21.0	VAPDSCBD2100	7.5	75	166.8	165	1.8	25	★
22.0	VAPDSCBD2200	7.5	75	166.8	165	1.8	25	★
23.0	VAPDSCBD2300	7.5	80	171.8	170	1.8	25	★
24.0	VAPDSCBD2400	8.5	80	172.2	170	2.2	25	★
25.0	VAPDSCBD2500	8.5	85	182.2	180	2.2	25	★
26.0	VAPDSCBD2600	9.0	85	182.2	180	2.2	32	★
27.0	VAPDSCBD2700	9.0	95	192.2	190	2.2	32	★
28.0	VAPDSCBD2800	10.0	95	192.6	190	2.6	32	★
29.0	VAPDSCBD2900	10.0	100	197.6	195	2.6	32	★
30.0	VAPDSCBD3000	11.0	100	197.6	195	2.6	32	★
31.0	VAPDSCBD3100	11.0	105	202.6	200	2.6	32	★
32.0	VAPDSCBD3200	13.0	105	202.6	200	2.6	32	★

★ : Lagerstandard in Japan.









## SCHNITTDATENEMPFEHLUNGEN

Material	P		N		P		K		P		M		P		M	
	Baustahl, Aluminium Leg.		C-Stahl Ck55, Legierter Stahl, Duktiles Gusseisen		Leg. Werkzeugstahl X210Cr12, (Werkstoffe mit geringer Härte) Ferritischer rostfreier Stahl, X10CrAl18, X10CrAl13 Martensitischer rostfreier Stahl, X20Cr13, X10CrAl13		Leg. Werkzeugstahl, X40CrMoV51 (-40HRC) Aushärtbarer rostfreier Stahl, X7CrNiAl177									
Bohrer Durchm. DC (mm)	Drehzahl (min <sup>-1</sup> )	Vorschub (mm/U.)	Drehzahl (min <sup>-1</sup> )	Vorschub (mm/U.)	Drehzahl (min <sup>-1</sup> )	Vorschub (mm/U.)	Drehzahl (min <sup>-1</sup> )	Vorschub (mm/U.)	Drehzahl (min <sup>-1</sup> )	Vorschub (mm/U.)	Drehzahl (min <sup>-1</sup> )	Vorschub (mm/U.)	Drehzahl (min <sup>-1</sup> )	Vorschub (mm/U.)	Drehzahl (min <sup>-1</sup> )	Vorschub (mm/U.)
2.0	5600	0.07	4800	0.07	3200	0.07	2800	0.04								
3.0	3700	0.10	3200	0.10	2100	0.10	1900	0.05								
4.0	2800	0.12	2400	0.12	1600	0.12	1400	0.06								
5.0	2200	0.14	1900	0.14	1300	0.14	1150	0.07								
6.0	1850	0.15	1600	0.15	1050	0.15	950	0.08								
8.0	1400	0.20	1200	0.20	800	0.20	720	0.10								
10.0	1100	0.23	960	0.23	640	0.21	570	0.11								
12.0	950	0.26	800	0.26	530	0.24	470	0.12								
14.0	800	0.27	680	0.27	450	0.25	410	0.13								
16.0	700	0.28	500	0.28	360	0.26	300	0.14								
18.0	620	0.29	450	0.29	320	0.27	260	0.15								
20.0	560	0.30	400	0.30	290	0.27	240	0.15								
22.0	510	0.32	360	0.32	260	0.29	220	0.16								
24.0	460	0.33	330	0.33	240	0.30	200	0.16								
26.0	430	0.35	310	0.35	220	0.31	180	0.17								
28.0	400	0.36	290	0.36	210	0.33	170	0.18								
30.0	370	0.37	270	0.37	190	0.34	160	0.18								
32.0	350	0.38	250	0.38	180	0.35	150	0.19								

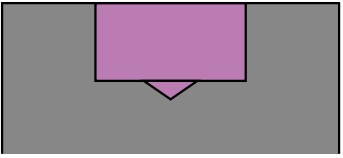
- Hinweis 1) Die angegebenen Schnittdaten beziehen sich auf Bohrtiefen bis DCx3 bei Bohrungen ohne Pilotbohrung. Wenn Löcher mit einer Tiefe kleiner als DCx1 gebohrt werden, kann die Drehzahl um 20 % erhöht werden.
- Hinweis 2) Es wird empfohlen auf eine Pilotbohrung zu verzichten. Wenn eine Pilotbohrung vorhanden ist, können die Späne möglicherweise nicht gebrochen werden. Wir empfehlen das Lüften, wenn die Späne gebrochen werden müssen.
- Hinweis 3) Beim Anbohren an geneigten Flächen ist die Verwendung eines Hartmetallfräsers zu empfehlen.
- Hinweis 4) Verringern Sie bei der Bearbeitung von rostfreien Austenitstählen (X5CrNi1810) die Drehzahl um 30 - 60 %, und reduzieren Sie den Vorschub um 40 - 60 %.
- Hinweis 5) Verwenden Sie ein Bohrfutter mit Spannvorrichtung.
- Hinweis 6) Verringern Sie in Abhängigkeit von der Bohrsituation Drehzahl und Vorschub, wenn Werkstück oder Maschine zu wenig Stabilität aufweisen.
- Hinweis 7) Verwenden Sie ausreichend Kühlschmierstoff.
- Hinweis 8) Die oben angegebenen Schnittdaten dienen als Leitfaden für die Verwendung eines wasserlöslichen Kühlschmierstoffes. Bei Verwendung eines nicht wasserlöslichen Kühlschmierstoffes muss die Drehzahl verringert werden.

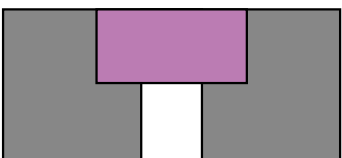
## EMPFOHLENE SCHNITTMETHODE

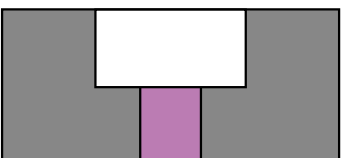
■ Mit VAPDSCB ist eine hocheffiziente Bearbeitung möglich, ohne dass es zu Spanstau kommt.

Herkömmliche Schnittmethode		VAPDSCB-Schnittmethode	
<p>① Bohren des Durchgangslochs</p> 	<p>Spangeometrie</p> 	<p>① Anbohren</p> 	<p>Spangeometrie</p> 
<p>② Anbohren</p> 	<p>Unsaubere Späne</p> 	<p>② Bohren des Durchgangslochs</p> 	<p>Gut</p> 

Hinweis 1) Falls beim Anbohren mit dem VAPDSCB zuerst eine Pilotbohrung durchgeführt wird, können lange, zusammenhängende Späne entstehen, die sich um das Werkzeug wickeln.

# BOHREN (VOLLHARTMETALL)

HARTMETALL

# MCC



P M K N S H **CFK**



Bearbeitungszentrum

X

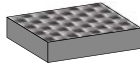

CFK

M

Externe Kühlung

BOHREN

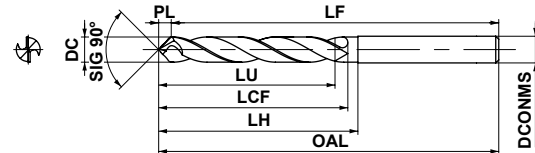

	3<DC≤6	6<DC≤10	10<DC≤18
	0 -0.018	0 -0.022	0 -0.027
	DCONMS=6	6<DCONMS≤10	10<DCONMS≤12
	0 -0.008	0 -0.009	0 -0.011

Loch Durchm.		Bohrer Durchm.		Bohrtiefe (L/D)	Bestellnummer	Sorte DD2105	Abmessungen (mm)						
* AWG	Zoll	DC (mm)	Zoll				LU	LCF	LH	OAL	LF	PL	DCONMS
—	3/16	4.76	.1875	3	<b>MCC0476X03S060</b>	★	16.7	40	40	80	77.6	2.4	6
—	1/4	6.38	.251	3	<b>MCC0638X03S080</b>	★	22.3	50	50	90	86.8	3.2	8
—	5/16	7.96	.3125	3	<b>MCC0796X03S080</b>	★	27.9	50	50	90	86.0	4.0	8
—	3/8	9.55	.375	3	<b>MCC0955X03S100</b>	★	33.5	50	50	100	95.2	4.8	10
—	7/16	11.14	.4375	3	<b>MCC1114X03S120</b>	★	39.0	60	60	110	104.4	5.6	12

\*AWG : American Wire Gage

## SCHNITTDATENEMPFEHLUNGEN

Material		X				
		CFK				
Bohrer Durchm. DC (mm)	Bohrer Durchm. DC (Zoll)	Schnittgeschw. (m/min)	Drehzahl (min <sup>-1</sup> )	Vorschub (Min.—Max.) (mm/U.)	Tischvorschub (mm/min)	
<b>4.76</b>	<b>.1875</b>	100	6700	0.08 (0.05—0.12)	540	
<b>6.38</b>	<b>.251</b>	100	5000	0.1 (0.05—0.12)	500	
<b>7.96</b>	<b>.3125</b>	100	4000	0.1 (0.05—0.12)	400	
<b>9.55</b>	<b>.375</b>	100	3400	0.1 (0.05—0.12)	340	
<b>11.14</b>	<b>.4375</b>	100	2900	0.1 (0.05—0.12)	290	

★ : Lagerstandard in Japan. □ : Herstellung nur auf Anfrage



P M K **N** S H CFK+AI

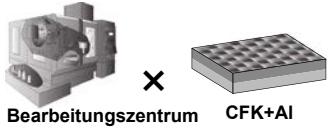

Interne Kühlung

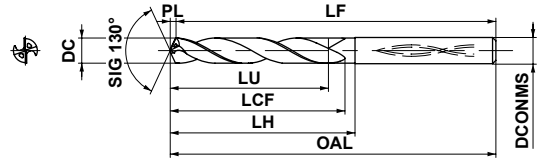

	$6 < DC \leq 10$
	$0$ $-0.022$
	$6 < DCONMS \leq 10$
	$0$ $-0.009$

Loch Durchm.		Bohrer Durchm.		Bohrtiefe	Bestellnummer	Sorte	Abmessungen (mm)						
AWG*	Zoll	DC (mm)	Zoll				(L/D)	DD2110	LU	LCF	LH	OAL	LF
—	1/4	6.38	.251	5	<b>MCA0638X05S070</b>	<input type="checkbox"/>	33.4	51	51	91	89.5	1.5	7
—	3/8	9.55	.375	5	<b>MCA0955X05S100</b>	<input type="checkbox"/>	50.0	77	77	118	115.8	2.2	10

\*AWG : American Wire Gage

## SCHNITTDATENEMPFEHLUNGEN

Material		X				N			
		CFK				Aluminium Leg. (Si<5%) ASTM AIMg1SiCu, ASTM Al-Zn6MgCu etc			
Bohrer Durchm. DC (mm)	Bohrer Durchm. DC (Zoll)	Schnittgeschw. (m/min)	Drehzahl (min <sup>-1</sup> )	Vorschub (Min.—Max.) (mm/U.)	Tischvorschub (mm/min)	Schnittgeschw. (m/min)	Drehzahl (min <sup>-1</sup> )	Vorschub (Min.—Max.) (mm/U.)	Tischvorschub (mm/min)
<b>6.38</b>	<b>.251</b>	100	5000	0.15 (0.10—0.20)	750	100	5000	0.03 (0.02—0.04)	150
<b>9.55</b>	<b>.375</b>	100	3400	0.15 (0.10—0.20)	680	100	3400	0.03 (0.02—0.04)	100

Hinweis 1) Wir empfehlen die Schneidbedingungen jedem Arbeitsmaterial anzupassen.

# BOHREN (VOLLHARTMETALL)

# MCT



P

M

K

N

S

H

CFK+Ti



X

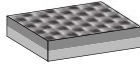

Bearbeitungszentrum

CFK+Ti

M

BOHREN

Interne Kühlung

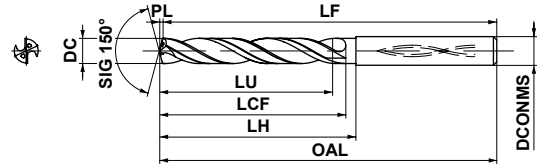

$6 < DC \leq 10$
$0$
$-0.022$
$6 < DCONMS \leq 10$
$0$
$-0.009$



Loch Durchm.		Bohrer Durchm.		Bohrtiefe (L/D)	Bestellnummer	Sorte TF15	Abmessungen (mm)						
AWG*	Zoll	DC (mm)	Zoll				LU	LCF	LH	OAL	LF	PL	DCONMS
—	1/4	6.38	.251	5	<b>MCT0638X05S070</b>	<input type="checkbox"/>	32.8	47	47	96	95.1	0.9	7
—	3/8	9.55	.375	5	<b>MCT0955X05S100</b>	<input type="checkbox"/>	49.1	71	71	122	120.7	1.3	10

\*AWG : American Wire Gage

## SCHNITTDATENEMPFEHLUNGEN

Material		X				S				
		CFK				Titanlegierung Ti-6Al-4V usw.				
Bohrer Durchm. DC (mm)	Bohrer Durchm. DC (Zoll)	Schnittgeschw. (m/min)	Drehzahl (min <sup>-1</sup> )	Vorschub (Min.—Max.) (mm/U.)	Tischvorschub (mm/min)	Schnittgeschw. (m/min)	Drehzahl (min <sup>-1</sup> )	Vorschub (Min.—Max.) (mm/U.)	Tischvorschub (mm/min)	Bearbeitung in Schritten (mm)
<b>6.38</b>	<b>.251</b>	100	5000	0.15 (0.10—0.20)	750	15	750	0.02 (0.01—0.03)	15	1
<b>9.55</b>	<b>.375</b>	100	3400	0.15 (0.10—0.20)	680	15	500	0.02 (0.01—0.03)	10	1

Hinweis 1) Bitte verwenden Sie Luft oder Ölnebel.

Hinweis 2) Wir empfehlen die Schnittbedingungen jedem Arbeitsmaterial anzupassen.

: Herstellung nur auf Anfrage

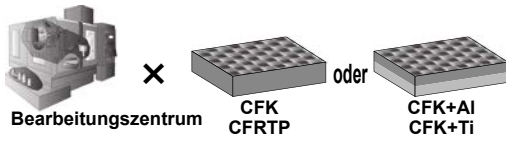

Interne Kühlung

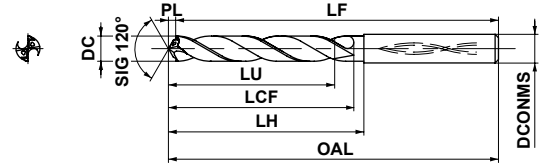

	$6 < DC \leq 10$
	$0$ $-0.022$
	$6 < DCONMS \leq 10$
	$0$ $-0.009$

Loch Durchm.		Bohrer Durchm.		Bohrtiefe (L/D)	Bestellnummer	Sorte		Abmessungen (mm)						
AWG*	Zoll	DC (mm)	Zoll			HT10	DD210	LU	LCF	LH	OAL	LF	PL	DCONMS
—	1/4	6.38	.251	5	<b>MCW0638X05S070</b>	<input type="checkbox"/>	<input type="checkbox"/>	33.7	52	52	92	90.2	1.8	7
—	3/8	9.55	.375	5	<b>MCW0955X05S100</b>	<input type="checkbox"/>	<input type="checkbox"/>	50.6	73	73	119	116.2	2.8	10

\*AWG : American Wire Gage

## SCHNITTDATENEMPFEHLUNGEN

Material		X				
		CFK				
Bohrer Durchm. DC (mm)	Bohrer Durchm. DC (Zoll)	Schnittgeschw. (m/min)	Drehzahl (min <sup>-1</sup> )	Vorschub (Min.—Max.) (mm/U.)	Tischvorschub (mm/min)	
<b>6.38</b>	<b>.251</b>	100	5000	0.15 (0.10—0.20)	750	
<b>9.55</b>	<b>.375</b>	100	3400	0.15 (0.10—0.20)	680	

Material		N					S				
		Aluminium Leg. (Si<5%) AlMg1SiCu, Al-Zn6MgCu usw.					Titanlegierung Ti-6Al-4V usw.				
Bohrer Durchm. DC (mm)	Bohrer Durchm. DC (Zoll)	Schnittgeschw. (m/min)	Drehzahl (min <sup>-1</sup> )	Vorschub (Min.—Max.) (mm/U.)	Tischvorschub (mm/min)	Bearbeitung in Schritten (mm)	Schnittgeschw. (m/min)	Drehzahl (min <sup>-1</sup> )	Vorschub (Min.—Max.) (mm/U.)	Tischvorschub (mm/min)	Bearbeitung in Schritten (mm)
<b>6.38</b>	<b>.251</b>	100	5000	0.15 (0.10—0.20)	750	3	15	750	0.02 (0.01—0.03)	15	1
<b>9.55</b>	<b>.375</b>	100	3400	0.15 (0.10—0.20)	500	3	15	500	0.02 (0.01—0.03)	10	1

Hinweis 1) Bitte verwenden sie Luft oder Ölnebel.

Hinweis 2) Wir empfehlen die Schnittbedingungen jedem Arbeitsmaterial anzupassen.

# BOHREN (VOLLHARTMETALL)

HARTMETALL

# MCCH



- P
- M
- K
- N
- S
- H
- CFK



×

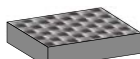

Handwerkzeug

CFK

M  
BOHREN

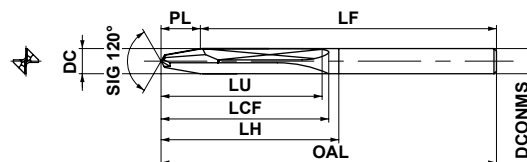

$1 \leq DC \leq 3$	$3 < DC \leq 6$	$6 < DC \leq 10$
0 -0.014	0 -0.018	0 -0.022
$DCONMS = 3$	$3 < DCONMS \leq 6$	$6 < DCONMS \leq 10$
0 -0.006	0 -0.008	0 -0.009



Loch Durchm.	Bohrer Durchm.		Bohrtiefe	Sorte	Abmessungen (mm)								
	Zoll	DC (mm)				Zoll	(L/D)	Bestellnummer	DT2030	LU	LCF	LH	OAL
#40	—	2.5	.0985	15	<b>MCCH0250X15S030</b>	★	42.1	48	50	100	95.4	4.6	3
#30	—	3.26	.1285	10	<b>MCCH0326X10S040</b>	★	38.6	48	50	100	94.0	6.0	4
#20	—	4.1	.1615	8	<b>MCCH0410X08S050</b>	★	40.3	48	50	100	92.5	7.5	5
#11	—	4.86	.1915	5	<b>MCCH0486X05S050</b>	★	33.2	48	50	100	91.1	8.9	5
—	1/4	6.38	.251	3	<b>MCCH0638X03S070</b>	★	30.8	48	50	100	88.3	11.7	7
—	3/8	9.55	.375	2	<b>MCCH0955X02S100</b>	★	36.6	48	50	100	82.5	17.5	10

\*AWG : American Wire Gage

Hinweis 1) Bitte vergewissern Sie sich, ob Ihr Werkzeug zur Bearbeitung geeignet ist.

★ : Lagerstandard in Japan.

# MCAH



HARTMETALL

P M K **N** S H CFK+AI



X

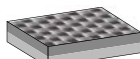

CFK+AI

Handwerkzeug

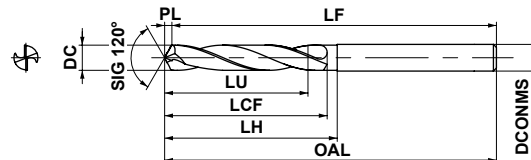

M

BOHREN

	$1 \leq DC \leq 3$	$3 < DC \leq 6$	$6 < DC \leq 10$
	0 -0.014	0 -0.018	0 -0.022
	$DCONMS=3$	$3 < DCONMS \leq 6$	$6 < DCONMS \leq 10$
	0 -0.006	0 -0.008	0 -0.009

Loch Durchm.		Bohrer Durchm.		Bohrtiefe (L/D)	Bestellnummer	Sorte DT2030	Abmessungen (mm)						
AWG*	Zoll	DC (mm)	Zoll				LU	LCF	LH	OAL	LF	PL	DCONMS
#40	—	2.5	.0985	15	<b>MCAH0250X15S030</b>	★	38.2	50	50	100	99.3	0.7	3
#30	—	3.26	.1285	15	<b>MCAH0326X15S040</b>	★	49.8	50	50	100	99.1	0.9	4
#20	—	4.1	.1615	10	<b>MCAH0410X10S050</b>	★	42.2	50	50	100	98.8	1.2	5
#11	—	4.86	.1915	8	<b>MCAH0486X08S050</b>	★	40.3	50	50	100	98.6	1.4	5
—	1/4	6.38	.251	5	<b>MCAH0638X05S070</b>	★	33.7	50	50	100	98.2	1.8	7
—	3/8	9.55	.375	3	<b>MCAH0955X03S100</b>	★	31.5	50	50	100	97.2	2.8	10

\*AWG : American Wire Gage

Hinweis 1) Bitte vergewissern Sie sich, ob Ihr Werkzeug zur Bearbeitung geeignet ist.

# Modularer Reibkopf RX1S

Einfach austauschbarer Kopf  
mit hoher Rundlaufgenauigkeit

Optimales Kopfdesign mit zielgerichteter  
Kühlmittelversorgung



**Spiralisierte Geometrie für  
Bauteil-Durchgangsbohrungen**

Seitliche Kühlmittelbohrungen in  
der Spannutt



**Gerade Schneidengeometrie für  
Bauteil-Grundlochbohrungen**

Zentrale Kühlmittelbohrung



Einfache Handhabung für hervorragende Bearbeitungsergebnisse

H7-Bohrungstoleranz

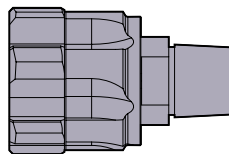
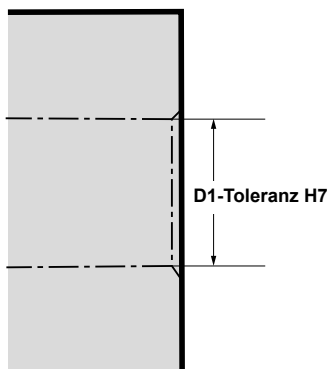



## Hochpräziser Montagemechanismus

Die hohe Rundlaufgenauigkeit und stabile Klemmung wird durch den Flächen-/Kegelkontakt erreicht.



## Vollhartmetallkopf

Hohe Schnittgeschwindigkeiten ermöglichen effizientere Leistung.

## Geläppte und polierte Schneidkante

Die ausgezeichnete Oberflächenqualität ermöglicht einen sehr guten Spanaustrag.

## Kurze und lange Halteroptionen verfügbar

X03



X05



## Für ein breites Anwendungsspektrum verschiedenster Werkstoffe

---

Die Kombination aus universellem Hartmetallsubstrat und PVD-Beschichtung sorgt für hochpräzises Reiben bei langer Werkzeugstandzeit.

M  
BOHREN



Stahl



Rostfreier  
Stahl

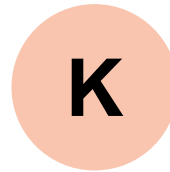

Guss



Hitzebeständige  
Legierungen

## Kundenspezifische Lösungen

---

Maßangefertigte, optimal konstruierte Reibköpfe mit unterschiedlichen Toleranzklassen können in 1- $\mu$ m-Schritten und in Durchmessern (DC) von 14 mm bis 29 mm hergestellt werden.



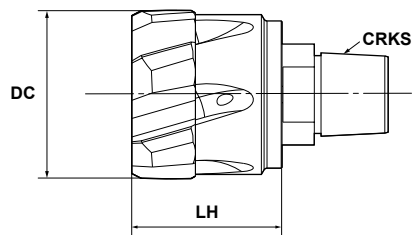

Typ 1

**M**

BOHREN

## Reibkopf mit spiralförmigen Schneiden für Durchgangsbohrungen

Mit seitlichen Kühlmittelbohrungen in den Schneiden

DC (mm)	Bestellnummer	Lager	Zähnezahl	LH (mm)	CRKS	Typ	Halter
		RP1010					
14	RX1S14000H7DHTP1	●	6	17.9	TP1	1	RX1SX○○S16ATP1
15	RX1S15000H7DHTP1	●	6	17.9	TP1	1	RX1SX○○S16ATP1
16	RX1S16000H7DHTP2	●	6	17.9	TP2	1	RX1SX○○S20ATP2
17	RX1S17000H7DHTP2	●	6	17.9	TP2	1	RX1SX○○S20ATP2
18	RX1S18000H7DHTP3	●	6	17.9	TP3	1	RX1SX○○S20ATP3
19	RX1S19000H7DHTP3	●	6	17.9	TP3	1	RX1SX○○S20ATP3
20	RX1S20000H7DHTP4	●	6	17.9	TP4	1	RX1SX○○S20ATP4
21	RX1S21000H7DHTP4	●	6	17.9	TP4	1	RX1SX○○S20ATP4
22	RX1S22000H7DHTP4	●	6	17.9	TP4	1	RX1SX○○S20ATP4
23	RX1S23000H7DHTP5	●	6	18.9	TP5	1	RX1SX○○S20ATP5
24	RX1S24000H7DHTP5	●	6	18.9	TP5	1	RX1SX○○S20ATP5
25	RX1S25000H7DHTP5	●	8	18.9	TP5	1	RX1SX○○S20ATP5
26	RX1S26000H7DHTP5	●	8	18.9	TP5	1	RX1SX○○S20ATP5
27	RX1S27000H7DHTP5	●	8	18.9	TP5	1	RX1SX○○S20ATP5
28	RX1S28000H7DHTP6	●	8	18.9	TP6	1	RX1SX○○S25ATP6
29	RX1S29000H7DHTP6	●	8	18.9	TP6	1	RX1SX○○S25ATP6

Hinweis 1) Die Schraubengröße CRKS muss für die Befestigungsgröße des Halters und des Kopfes dieselbe sein.

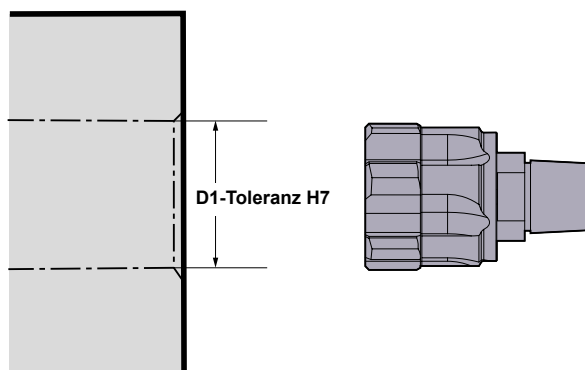

● : Lagerstandard.

## RX1S NEW

M

BOHREN

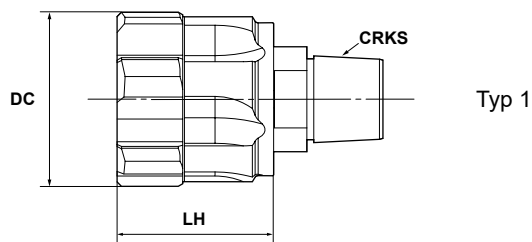

### Reibkopf mit geraden Schneiden für Sacklochbohrungen

Mit zentraler Kühlmittelbohrung

DC (mm)	Bestellnummer	Lager	Zähnezahl	LH (mm)	CRKS	Typ	Halter
		RP1010					
14	RX1S14000H7DSTP1	●	6	17.9	TP1	1	RX1SX○○S16ATP1
15	RX1S15000H7DSTP1	●	6	17.9	TP1	1	RX1SX○○S16ATP1
16	RX1S16000H7DSTP2	●	6	17.9	TP2	1	RX1SX○○S20ATP2
17	RX1S17000H7DSTP2	●	6	17.9	TP2	1	RX1SX○○S20ATP2
18	RX1S18000H7DSTP3	●	6	17.9	TP3	1	RX1SX○○S20ATP3
19	RX1S19000H7DSTP3	●	6	17.9	TP3	1	RX1SX○○S20ATP3
20	RX1S20000H7DSTP4	●	6	17.9	TP4	1	RX1SX○○S20ATP4
21	RX1S21000H7DSTP4	●	6	17.9	TP4	1	RX1SX○○S20ATP4
22	RX1S22000H7DSTP4	●	6	17.9	TP4	1	RX1SX○○S20ATP4
23	RX1S23000H7DSTP5	●	6	18.9	TP5	1	RX1SX○○S20ATP5
24	RX1S24000H7DSTP5	●	6	18.9	TP5	1	RX1SX○○S20ATP5
25	RX1S25000H7DSTP5	●	8	18.9	TP5	1	RX1SX○○S20ATP5
26	RX1S26000H7DSTP5	●	8	18.9	TP5	1	RX1SX○○S20ATP5
27	RX1S27000H7DSTP5	●	8	18.9	TP5	1	RX1SX○○S20ATP5
28	RX1S28000H7DSTP6	●	8	18.9	TP6	1	RX1SX○○S25ATP6
29	RX1S29000H7DSTP6	●	8	18.9	TP6	1	RX1SX○○S25ATP6

Hinweis 1) Die Schraubengröße CRKS muss für die Befestigungsgröße des Halters und des Kopfes dieselbe sein.

● : Lagerstandard.

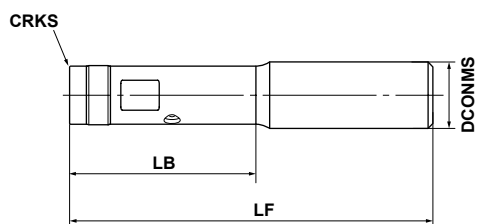

12<DCONMS<16	20<DCONMS<25
0	0
-0.011	-0.013

M

BOHREN

## HALTER

CRKS	Bestellnummer	Lager	Abmessungen (mm)				
			LB	LF	DCONMS	Min. Kopf-DC	Max. Kopf-DC
TP1	<b>RX1SX03S16ATP1</b>	●	35.0	91.0	16	14	15
TP1	<b>RX1SX05S16ATP1</b>	●	67.0	123.0	16	14	15
TP2	<b>RX1SX03S20ATP2</b>	●	39.0	99.0	20	16	17
TP2	<b>RX1SX05S20ATP2</b>	●	75.0	135.0	20	16	17
TP3	<b>RX1SX03S20ATP3</b>	●	45.0	106.0	20	18	19
TP3	<b>RX1SX05S20ATP3</b>	●	85.0	146.0	20	18	19
TP4	<b>RX1SX03S20ATP4</b>	●	51.5	113.5	20	20	22
TP4	<b>RX1SX05S20ATP4</b>	●	96.5	158.5	20	20	22
TP5	<b>RX1SX03S20ATP5</b>	●	65.5	130.5	20	23	27
TP5	<b>RX1SX05S20ATP5</b>	●	120.5	185.5	20	23	27
TP6	<b>RX1SX03S25ATP6</b>	●	80.5	152.5	25	28	29
TP6	<b>RX1SX05S25ATP6</b>	●	145.5	217.5	25	28	29

Hinweis 1) Die Schraubengröße CRKS muss für die Befestigungsgröße des Halters und des Kopfes dieselbe sein.  
Hinweis 2) Dem Halter ist kein Schlüssel beigelegt.

## ERSATZTEILE

Ausführungen			
	Klemmschraube	Anschlussgröße	Dreh-moment (N•m)
<b>RX1SX</b> ○ ○ <b>S16ATP1</b>	RX1ST8TP1	T8	2
<b>RX1SX</b> ○ ○ <b>S20ATP2</b>	RX1ST10TP23	T10	3
<b>RX1SX</b> ○ ○ <b>S20ATP3</b>	RX1ST10TP23	T10	3
<b>RX1SX</b> ○ ○ <b>S20ATP4</b>	RX1ST15TP45	T15	5
<b>RX1SX</b> ○ ○ <b>S20ATP5</b>	RX1ST15TP45	T15	5
<b>RX1SX</b> ○ ○ <b>S25ATP6</b>	RX1ST25TP6	T25	9

Hinweis 1) Die Verpackungseinheit von Ersatzschrauben beinhaltet 1 Stück.

## ZUBEHÖR SEPARAT ERHÄLTICH

Ausführungen	
	Schlüssel
<b>RX1SX</b> ○ ○ <b>S16ATP1</b>	TKY08W
<b>RX1SX</b> ○ ○ <b>S20ATP2</b>	TKY10F
<b>RX1SX</b> ○ ○ <b>S20ATP3</b>	TKY10F
<b>RX1SX</b> ○ ○ <b>S20ATP4</b>	TKY15T
<b>RX1SX</b> ○ ○ <b>S20ATP5</b>	TKY15T
<b>RX1SX</b> ○ ○ <b>S25ATP6</b>	TKY25T

# RX1S NEW

## SCHNITTDATENEMPFEHLUNGEN

	Material	Eigenschaften	Schnittgeschw. (m/min)	Vorschub (mm/Zahn)	
				DC<20	DC≥20
<b>P</b>	Allg. Baustahl (St44-2, C10 usw.)	Härte ≤180HB	120 (90–155)	0.10–0.20	0.10–0.22
	C-Stahl, Leg. Stahl (CK45, 41CrMo4 usw.)	Härte 180–280HB	120 (90–155)	0.10–0.20	0.10–0.22
	C-Stahl, Leg. Stahl (40CrNiMoA usw.)	Härte 280–350HB	100 (75–130)	0.10–0.20	0.10–0.22
<b>M</b>	Rostfreier Stahl (austenitisch) (X5CrNi18-10, X5CrNiMo17-12-2 usw.)	Härte ≤200HB	20 (15–30)	0.08–0.15	0.08–0.18
	Ferritisch rostfreier Stahl (X6Cr17 usw.)	–	40 (30–60)	0.08–0.18	0.08–0.20
	Duplexstahl (CrNiMoN 22 5 3 usw.)	–	20 (15–30)	0.08–0.15	0.08–0.18
	Gehärtete rostfreie PH-Stähle (17-4PH usw.)	–	40 (30–60)	0.08–0.18	0.08–0.20
<b>K</b>	Grauguss (GG-30 usw.)	Zugfestigkeit ≤350MPa	110 (80–130)	0.10–0.20	0.10–0.22
	Duktiler Guss (GGG-40 usw.)	Zugfestigkeit ≤450MPa	90 (65–110)	0.10–0.20	0.10–0.22
<b>S</b>	Hitzebeständige Legierung (Inconel®718 usw.)	–	30 (20–40)	0.08–0.18	0.10–0.20
	Titanlegierung (Ti-6Al-4V usw.)	–	30 (20–40)	0.08–0.18	0.10–0.20

**M**  
BOHREN

## REIBAUFMASSE NACH DURCHMESSER

(mm)

DC	14≤DC<15	15≤DC<20	20≤DC≤29
Reibaufmaß	0.15–0.30	0.15–0.35	0.20–0.40

# BEFESTIGUNG DES KOPFS

# 1

Verwenden Sie einen Torx-Schlüssel, um den Überstand entsprechend dem unten angegebenen L-Maß anzupassen. Da die Schneidkanten scharf sind, sollten Sie Schutzhandschuhe tragen.

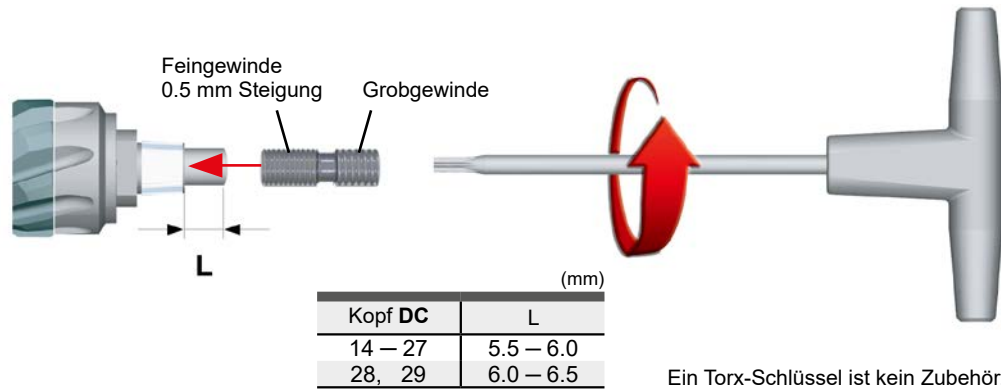

# 2

Setzen Sie den Kopf in den Halter ein. Ein kleiner, paralleler Spalt sollte zwischen der Stirnfläche des Halters und dem Kopf zu sehen sein.

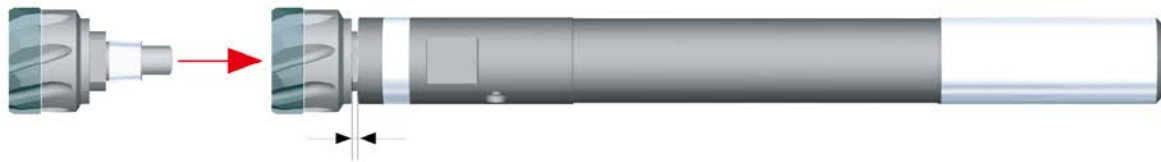

# 3

Verwenden Sie einen Torx-Schlüssel zum Festziehen, bis Halter und Kopf fest eingespannt sind.

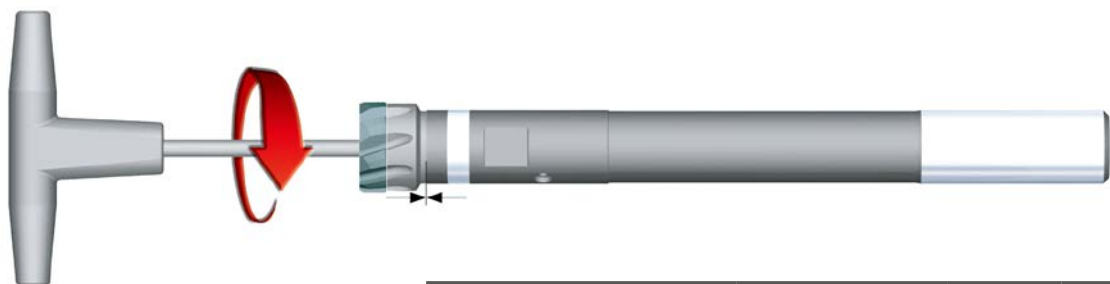

Ausführung	Klemmschraube	Anschlussgröße	Drehmoment (N·m)
RX1SX S16ATP1	RX1ST8TP1	T8	2
RX1SX S20ATP2, TP3	RX1ST10TP23	T10	3
RX1SX S20ATP4, TP5	RX1ST15TP45	T15	5
RX1SX S25ATP6	RX1ST25TP6	T25	9

Hinweis 1) Die Verpackungseinheit von Ersatzschrauben beinhaltet 5 Stück.

- Verwenden Sie bitte einen spiralsierten Reibkopf für Durchgangsbohrungen und einen geraden Reibkopf für Grundlochbohrungen.  
Die spiralisierte Form ist darauf ausgelegt, Späne nach vorn abzuführen, die gerade Form ist darauf ausgelegt, Späne nach hinten abzuführen.

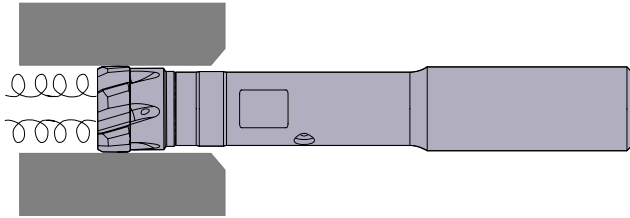

spiralsgenutet

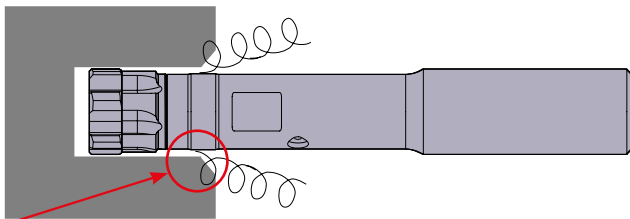

geradgenutet

- Es wird empfohlen, den Eintritt in die zu bearbeitende Bohrung vor dem Reiben zu senken / fassen.
- Im Allgemeinen wird beim Reiben empfohlen, das Werkzeug mit dem gleichen Vorschub zurückzuführen.
- Bei der Verwendung des Werkzeugs in der Maschine sollte die Rundlaufgenauigkeit 5 µm oder weniger betragen.
- Die Verwendung eines hydraulischen Spannfitter wird empfohlen.

- Die erste Anwendungsempfehlung zur Erzielung optimaler Ergebnisse ist die Verwendung der internen Kühlmittelversorgung. Die zweite Anwendungsempfehlung stellt die externe Kühlmittelversorgung dar. Trockene Bearbeitung wird nicht empfohlen. Bei Grundlochlöchern wird das Reiben mit externer Kühlmittelversorgung über eine Tiefe von mehr als  $DC \times 3$  nicht empfohlen.

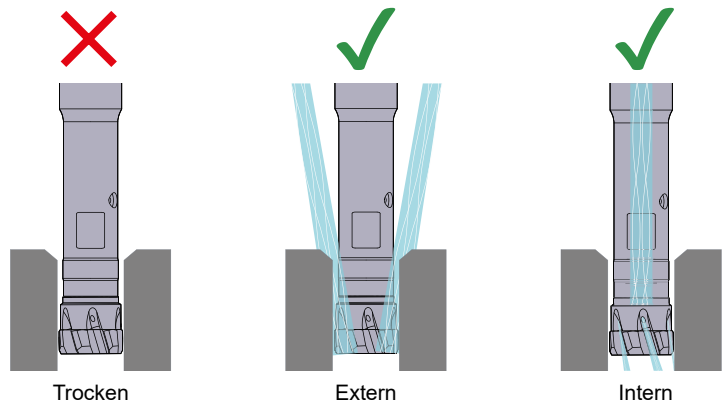

- Bei der Verwendung der internen Kühlmittelversorgung muss der Druck unter 8 MPa liegen.

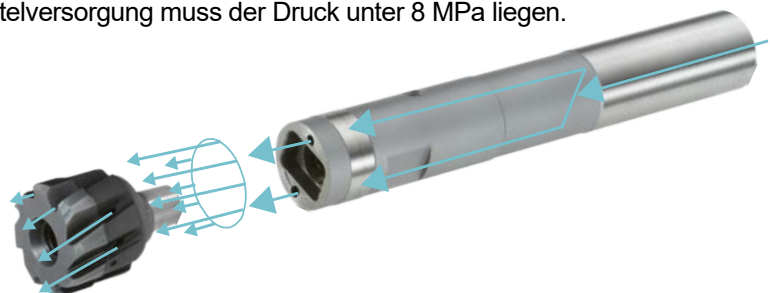

- Die Bearbeitung diagonaler Querbohrungen wird nicht empfohlen.

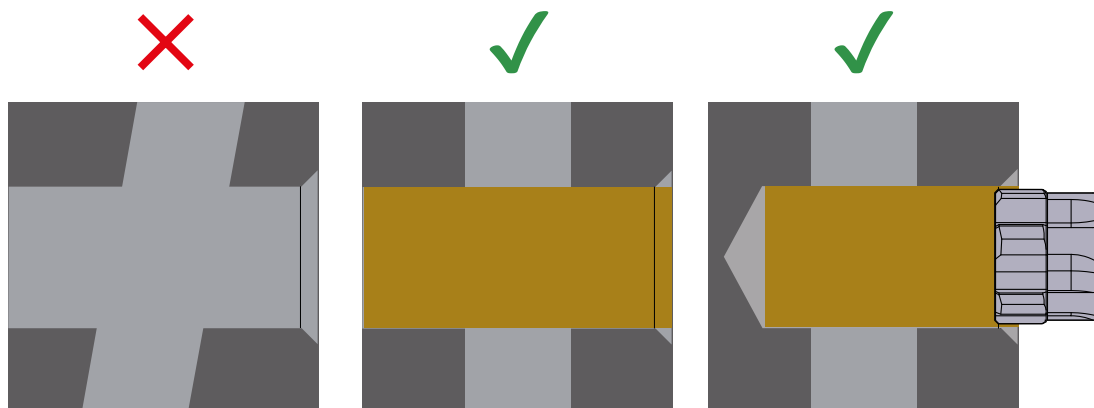

- Bitte fassen Sie die Bohrung vor dem Reiben an.

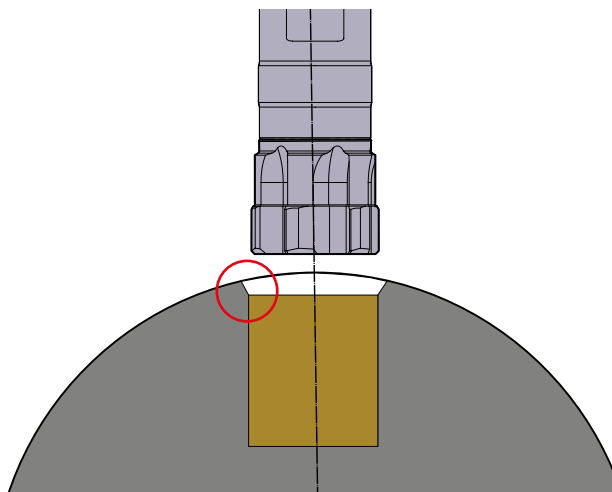

- Das Reiben von geschichteten Materiallagen oder konkaven Flächen ist möglich.

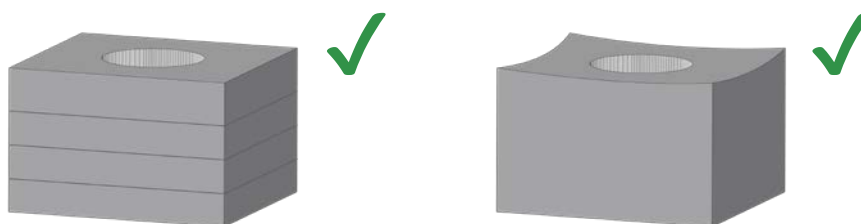

- Wenn der Eintritt/Austritt der Bohrung auf einer geneigten Oberfläche liegt, wird das Reiben nicht empfohlen.

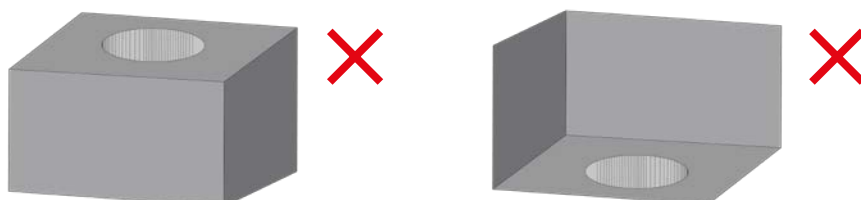

# Notizen

---

A series of horizontal dashed lines for writing notes, spanning the width of the page.



# ERSATZTEILE

IDENTIFIZIERUNG .....	N002
ERSATZTEILE	
KLEMMSCHRAUBEN .....	N003
SCHRAUBE .....	N008
EINSTELLSCHRAUBE / PRÄZISIONS-STELLMUTTER .....	N009
UNTERLEGPLATTE .....	N010
BEFESTIGUNGSFEDER UND KNIEHEBEL .....	N013
KNIEHEBEL .....	N014
SPANNPRATZE .....	N014
SPANBRECHER .....	N016
KUPFERPASTEN .....	N017



# IDENTIFIZIERUNG

ERSATZTEILE

## IDENTIFIZIERUNG VON KLEMMSCHRAUBEN (Grobgewinde in Rechtsausführung)

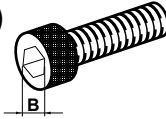

**H SC 060 05**

Länge

Beispiel	
Symbol	L
05	5
10	10
20	20
30	30

Schrauben Durchmesser

Beispiel	
Symbol	d
050	M5
060	M6

### Hexagonale Lochabmessungen

Durchmesser	Gewindesteigung	B Abmessungen			
		HBH	HFC	HSC	HS $\odot$
M2	0.4	—	—	1.5	0.9
M2.5	0.45	—	—	2	1.3
M3	0.5	2	2	2.5	1.5
M4	0.7	2.5	2.5	3	2
M5	0.8	3	3	4	2.5
M6	1	4	4	5	3
M8	1.25	5	5	6	4
M10	1.5	6	6	8	5

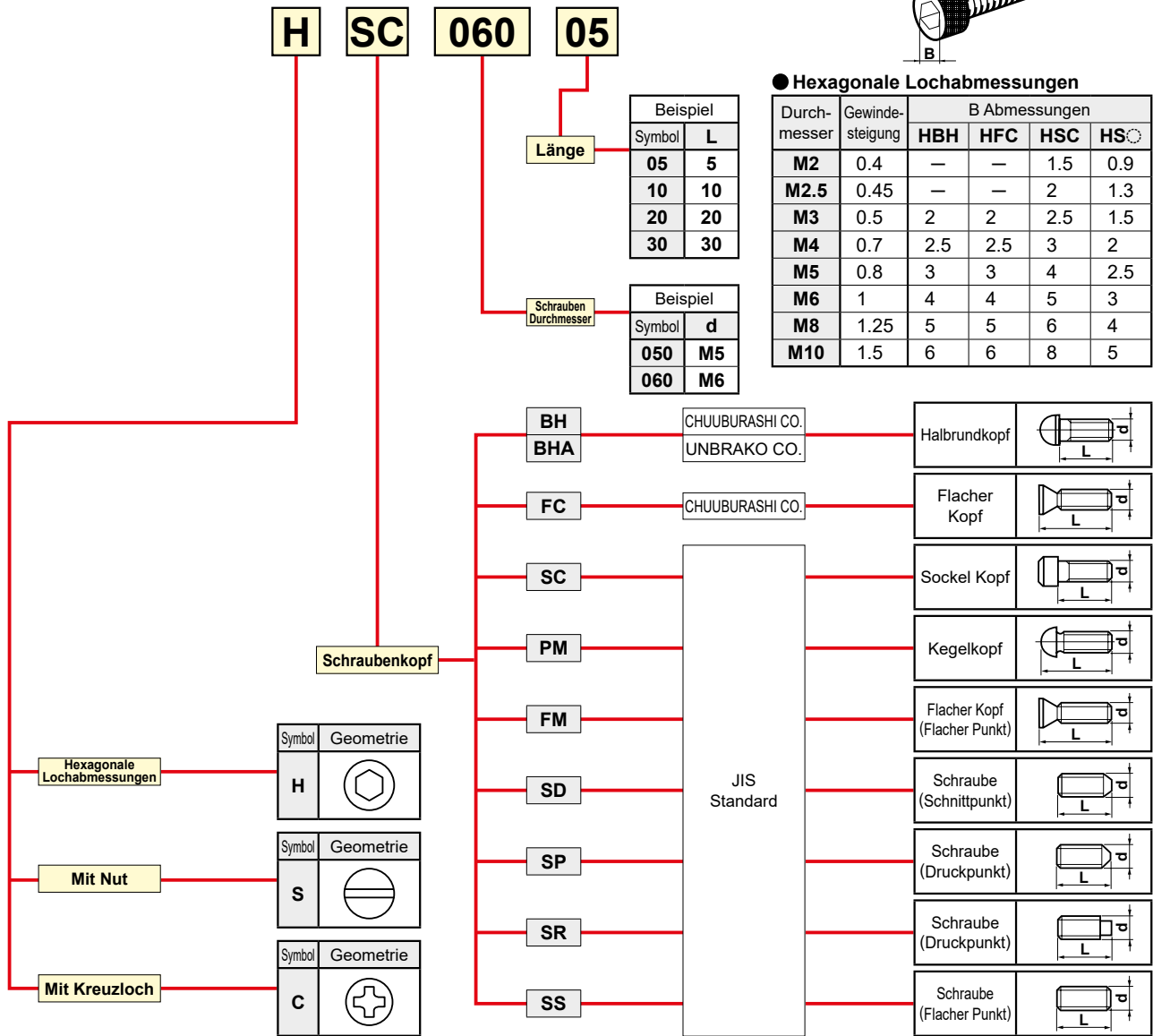

## IDENTIFIZIERUNG VON SCHLÜSSEL

**HKY 15 R**

Symbol	Schlüssel
HKY	Hexagonaler Schlüssel
TKY	Torx Schlüssel
RKY	R Schlüssel
TIP	Torx plus Schlüssel

Hexagonaler Schlüssel	
Symbol	B
15	1.5
20	2
25	2.5
30	3
35	3.5
40	4
50	5
60	6

Torx Schlüssel		
Symbol	B	Größe
06	1.7	T6
08	2.3	T8
10	2.7	T10
15	3.3	T15
20	3.8	T20
25	4.4	T25
27	5.0	T27
30	5.5	T30

Torx plus Schlüssel		
Symbol	B	Größe
06	1.8	6IP
07	2.1	7IP
08	2.4	8IP
10	2.8	10IP
15	3.4	15IP

R	Standard L-Schlüssel	
L	L-Schlüssel in langer Ausführung	
T	T-Schlüssel	
F	Flaggen-schlüssel	
FS	Flaggen-schlüssel	
W	Flaggen-schlüssel	
D	Schraubendreher	
DS	Schraubendreher	
S	Schlüssel	

**IMX 10 - WR**

Symbol	Schlüssel
IMX	Schlüssel für iMX Serie

Hexagonaler Schlüssel	
Symbol	B
10	8
12	10
16	13
20	16
25	20

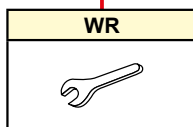

# ERSATZTEILE

## KLEMMSCHRAUBEN

Geometrie	Bestellnummer	Abmessungen (mm)					Winkel	MPCDS	TQ (N·m)	Werkzeughalter
		MPCA	MPCB	MPCC	MPCD	MPCE				
	<b>AJS3010T10</b>	5	M3×0.5	10	1.5	2.8	120°	T10	2.5	<b>Profil Halter</b> (☉C032) <b>AJX</b> (☉K194) <b>AJX</b> (☉K194)
	<b>AJS4012T15</b>	7	M4×0.7	12	2.2	3.4	120°	T15	3.5	
	<b>AJS5014T25</b>	8	M5×0.8	14	2.7	4.5	120°	T25	7.5	
	<b>BRS103</b>	5	M3×0.5	9.9	2.9	3.4	120°	T15	3.5	
	<b>BRS105</b>	8	M5×0.8	13.8	3.8	4.5	120°	T25	7.5	
	<b>CS200T</b>	3.2	M2×0.4	5	1.6	1.8	90°	T6	0.6	<b>F</b> Bohrstange (☉E028) <b>Fräswerkzeug</b> -Serien (☉K001) <b>BRP</b> (☉K206) <b>DCCC</b> (☉K216) <b>MMTI</b> Bohrstange (☉G026) <b>BRP</b> (☉K206) <b>DCCC</b> (☉K216) <b>AL</b> Halter (☉C034) <b>AHX640S</b> (☉K042)
	<b>CS250T</b>	3.7	M2.5×0.45	6	1.8	2.4	90°	T8	1.0	
	* <b>CS250560T</b>	3.9	M2.5×0.45	5.2	2.5	2.4	60°	T8	1.0	
	<b>CS300590T</b>	4.1	M3×0.5	5.5	2.1	2.4	90°	T8	1.0	
	<b>CS300890T</b>	4.1	M3×0.5	8	2.1	2.4	90°	T8	1.0	
	* <b>CS350860T</b>	5.5	M3.5×0.6	8.4	4.0	3.4	60°	T15	3.5	
	<b>CS350990T</b>	4.8	M3.5×0.6	9	2.4	2.8	90°	T10	2.5	
	<b>CS401160T</b>	5.7	M4×0.7	11	4.5	3.4	60°	T15	3.5	
	<b>CS401990T</b>	6.0	M4×0.7	19	3.0	3.9	90°	T20	3.5	
	<b>CS451190T</b>	6.3	M4.5×0.75	11	2.9	3.9	90°	T20	5.0	
	* <b>CS5015060T</b>	7.2	M5×0.8	15	2.4	3.9	60°	T20	5.0	
<b>CS502190T</b>	8.5	M5×0.8	21	4.0	5.1	90°	T27	7.5		
	<b>CSF401260T</b>	7.2	M4×0.5	12	5.2	3.9	60°	T20	5.0	<b>PMR</b> (☉K252)
	<b>DC0520T</b>	8.5	M5×0.8	22.5	2.5	3.4	—	T15	3.5	<b>DOPPELKLEMM</b> Halter (☉C008) <b>DIMPLE BAR-BOHRSTANGE</b> (☉E015) <b>HSK</b> System (☉H001)
	<b>DC0621T</b>	10.5	M6×1.0	25	4	3.9	—	T20	5.0	
	<b>DKS4</b>	5.6	M4×0.7	18	3.5	3	—	—	3.3	
	<b>FC400890T</b>	5.6	M4×0.7	7.5	1.3	2.8	90°	T10	2.5	<b>AL</b> Halter (☉C035) <b>AL</b> Bohrstange (☉E043)
	<b>GY05016S</b>	8.7	M5×0.8	16	3.5	3.9	90°	T20	5.0	<b>GY</b> Serie (☉F004)
	<b>GY06013M</b>	12	M6×1	18	5	5.6	—	T30	6.0	<b>GY</b> Serie (☉F004)
	<b>HSP05008C</b>	M5×0.8	8	—	—	2.5	—	—	2.5	<b>MP</b> Halter (☉C019)

N

ERSATZTEILE

# ERSATZTEILE

## KLEMMSCHRAUBEN

ERSATZTEILE

Geometrie	Bestellnummer	Abmessungen (mm)					Winkel B1	MPCDS	TQ (N·m)	Werkzeughalter
		MPCA	MPCB	MPCC	MPCD	MPCPE				
	HY-A1	4.4	M3×0.5	7	2.1	2	82°	—	1.5	
	HY-V1	5.5	M3×0.5	7	2.5	2	82°	—	1.5	
	HY2	5.5	M3×0.5	10	2.5	2	82°	—	1.5	
	HY3	7	M3.5×0.6	12	2.9	2	82°	—	1.5	
	HY4	9.3	M5×0.8	16	3.6	3	82°	—	3.3	
	JSS6	6.9	M6×0.75	4.5	1.5	0.8	—	—	—	
	JSS7	8	M7×0.75	4.4	1.5	1	—	—	—	
	KS1	7	M4×0.7	14	5	—	—	—	—	
	KS2	10	M6×1	18	7	—	—	—	—	
	KS2S	10	M6×1	18	7	—	—	—	—	
	LLR1	M5×0.8	—	3.5	—	2.5	—	—	—	
	LLR2	M6×1	—	5	—	3	—	—	—	
<p>LLCS103, LLC105 LLCS112, LLC125 LLCS205</p> <p>Mit "★" gekennzeichnete Produkte sind am Ende nicht mit der mit MPCB gekennzeichneten Bohrung ausgestattet.</p> <p>Mit "☆☆" gekennzeichnete Produkte sind am Ende nicht mit der mit MPCA gekennzeichneten Bohrung ausgestattet.</p>	☆☆ LLC103	M3×0.5	4	11	4.6	2	—	—	1.5	P Bohrstange (⊕E038) HSK System (⊕H001)
	★ LLC105	M5×0.8	M5×0.8	10	1.5	2	—	—	1.5	
	LLCS106	M6×1	6	16.5	3.5	2.5	—	—	2.2	
	★ LLC106S	M6×1	6	13.4	0.7	2.5	—	—	2.2	
	LLCS108	M8×1.25	8	21	6.5	3	—	—	3.3	
	★ LLC108S	M8×1.25	8	16.5	2	3	—	—	3.3	
	LLCS110	M10×1.5	10	29	8	4	—	—	7.0	
	LLCS112	M12×1	11.9	36.2	9	5	—	—	8.0	
	LLCS125	M5×0.8	M5×0.8	12	2	2	—	—	1.5	
	LLCS205	M5×0.8	M5×0.8	16	4	2	—	—	1.5	
	LLCS206	M6×1	6	26	13	2.5	—	—	2.2	
	LLCS208	M8×1.25	8	24	6.5	3	—	—	3.3	
	LLCS306	M6×1	6	21	4	2.5	—	—	2.2	
	LLCS310	M10×1	10	29	8	4	—	—	7.0	
LLCS410	M10×1	10	30	6.6	4	—	—	7.0		
LLCS508	M8×1	8	24	6.5	3	—	—	3.3		
★ LLC508S	M8×1	8	20.5	3	3	—	—	3.3		
<p>Linke Schraubenausführung      Rechte Schraubenausführung</p> <p>*Ohne Sechskantloch an Schraube in Rechtsausführung</p>	LS1	M6×1	22	8	8	3	—	—	5.0	Fräswerkzeug-Serien (⊕K001)
	LS2	M8×1	29	13	10	4	—	—	8.2	
	★ LS4	M6×1	15	8	4	3	—	—	5.0	
	★ LS5	M6×1	18	8	5	3	—	—	5.0	
	★ LS6	M8×1	24	13	5	4	—	—	8.2	
	★ LS7	M8×1	27	13	8	4	—	—	8.2	
	★ LS8	M6×0.75	18	7	7	3	—	—	5.0	
	★ LS9	M6×0.75	22	8	8	3	—	—	5.0	
	★ LS10	M7×0.75	16	6	6	4	—	—	8.2	
	★ LS11	M8×1	16	6	6	4	—	—	7.8	
	★ LS12	M8×1	24	7	7	4	—	—	7.8	
	★ LS16	M7×0.75	23	11	8	4	—	—	7.8	
	★ LS20	M10×1.5	26	9	9	5	—	—	9.0	
	★ LS21	M10×1.5	32	12	12	5	—	—	9.0	
LS24	M8×1.25	24	8.5	8.5	4	—	—	7.8		
LS25	M8×1	28.5	12.0	10.5	4	—	—	8.2		
<p>Linke Schraubenausführung      Rechte Schraubenausführung</p>	LS14T	M7×0.75	24	10	10	4.5	—	T25	8.0	DOPPELKLEMM Halter (⊕C009)
	LS15T	M7×0.75	18	7	7	4.5	—	T25	8.0	
	LS10TS	M7×0.75	13	6	4	4.5	—	T25	8.5	
	LS0622T	M6×0.75	22	8	8	3.4	—	T15	6.0	
										AHX640W (⊕K049)

Geometrie	Bestellnummer	Abmessungen (mm)					Winkel	MPCDS	TQ (N·m)	Werkzeughalter
		MPCA	MPCB	MPCC	MPCD	MPCE				
	<b>MGS6</b>	10	M6×1	26	4	5	—	—	9.0	APX3000 (⊕K146)
	<b>MHT1</b>	11	M8×1	18.5	3.5	4	—	—	8.7	
	<b>NS251</b>	3.6	M2.5×0.45	7	—	2.2	60°	—	0.7	BT VH (⊕D016)
	<b>NS401</b>	5.8	M4×0.7	6	—	3.6	60°	—	3.5	CTAH-S (⊕D020)
	<b>NS402W</b>	5.85	M4×0.7	10	—	2.2	60°	—	0.7	CTAH (⊕D020) CTBH (⊕D022)
	<b>NS403W</b>	5.85	M4×0.7	12	—	2.2	60°	—	0.7	
	<b>NS404W</b>	5.8	M4×0.7	10	—	2.2	90°	—	0.7	
	<b>NS501W</b>	8	M5×0.8	16	—	2.5	120°	—	2.2	SMALL TOOLS (⊕D001)
	<b>NS502W</b>	8	M5×0.8	20	—	2.5	120°	—	2.2	
	<b>RS3008T</b>	4.3	M3×0.35	8.6	2	2.4	61°	T8	1.5	SRF (⊕K228) SUF (⊕K232)
	<b>RS3510T</b>	5	M3.5×0.35	10	2.3	2.8	61°	T10	2.5	
	<b>RS4015T</b>	6	M4×0.5	14	2.7	3.4	61°	T15	3.3	
	<b>RS5020T</b>	8.1	M5×0.5	16.4	3.6	3.9	61°	T20	5.0	
	<b>RS6025T</b>	9.5	M6×0.75	21.5	4.2	4.5	61°	T25	7.5	
	<b>RS8030T</b>	12	M8×0.75	25	5	5.6	61°	T30	10.0	
	<b>S1</b>	3.5	M2×0.4	5.5	2.2	1.5	92°	—	0.6	
	<b>S3</b>	4.5	M3×0.5	7.7	2.4	2	92°	—	1.5	
	<b>S4</b>	5.3	M4×0.7	8	1.8	2.5	62°	—	2.2	
	<b>S5</b>	6.8	M5×0.8	9	2.4	3	62°	—	3.3	
	<b>SD32</b>	12	M8×1.25	28	7.2	6	50°	—	9.5	
	<b>SD40</b>	12	M8×1.25	36	7.2	6	50°	—	9.5	
	<b>SD50</b>	16	M10×1.5	46	8.2	8	50°	—	1.0	
	<b>SD63</b>	16	M10×1.5	61	8.2	8	50°	—	1.0	
	<b>SETS51</b>	6.8	M5×0.8	14.8	1.5	3.4	—	T15	3.5	MMTE Halter (⊕G019) MMTI Bohrstange (⊕G026) HSK System (⊕H001)
	<b>SETS61</b>	8	M6×1	20	1.8	3.9	—	T20	5.0	
	<b>SLCS105</b>	10	M5×0.8	25	6.3	4	90°	—	7.0	WP Halter (⊕C017)
	<b>SLCS106</b>	12	M6×1	32	6.2	4	90°	—	7.0	
	<b>SPS1</b>	8.5	M5×0.8	16	4	4.5	70°	T25	5.0	
	<b>SRS5</b>	6.7	M5×0.8	16	3.5	3.9	—	T20	5.0	

# ERSATZTEILE

## KLEMMSCHRAUBEN

ERSATZTEILE

N

Geometrie	Bestellnummer	Abmessungen (mm)					Winkel	MPCDS	TQ (N·m)	Werkzeughalter
		MPCA	MPCB	MPCC	MPCD	MPCE				
	* TS16	2.5	M1.6×0.35	3.2	1.6	1.8	60°	T6	0.6	MICRO-DEX (☉E018)
	TS2	2.7	M2×0.4	4.6	1.4	1.8	60°	T6	0.6	
	* TS2A	2.7	M2×0.4	4.5	1.2	1.8	60°	T6	0.6	AQX (☉K186)
	TS2C	2.7	M2×0.4	3.8	1.4	1.8	60°	T6	0.6	
	☆ TS2D	3.8	M2×0.4	5.3	1.9	1.8	82°	T6	0.6	DIMPLE BAR (☉E007)
	TS21	2.7	M2×0.4	3.4	1.4	1.8	60°	T6	0.6	F Bohrstange (☉E030)
	* TS22	3.0	M2.2×0.45	5	1.2	1.8	60°	T6	0.6	S Bohrstange (☉E031)
	* TS25	3.3	M2.5×0.45	5.5	1.7	2.4	60°	T8	1.0	AQX (☉K186) AJX (☉K194)
	☆ TS25D	4.4	M2.5×0.45	6.2	2.2	2.4	82°	T8	1.0	MMTI Bohrstange (☉G026)
	* TS25H	3.6	M2.5×0.45	5.5	2	2.4	60°	T8	1.0	SRM2 (☉K236)
	TS202	2.7	M2×0.4	5.5	1.8	1.8	60°	T6	0.6	
	TS253	3.3	M2.5×0.45	4.5	1.7	2.4	60°	T8	1.0	Fräswerkzeug-Serien (☉K001)
	TS254	3.3	M2.5×0.45	7	1.7	2.4	60°	T8	1.0	SMALL TOOLS (☉D001) PMF (☉K250)
	* TS255	3.5	M2.5×0.45	7.5	1.6	2.4	60°	T8	1.0	Profil Halter (☉C032)
	TS3	3.9	M3×0.5	6	2	2.4	60°	T8	1.0	TSMP (☉K248)
	TS3D	5.0	M3×0.5	6	2.3	2.8	82°	T10	2.5	DIMPLE BAR (☉E007)
	* TS3SB	4.4	M3×0.5	8	2	2.4	80°	T8	1.5	AXD4000 (☉K168)
	TS3SBS	4.4	M3×0.5	6.5	2	2.4	80°	T8	1.5	AXD4000 (☉K168)
	☆ TS31D	4.8	M3×0.5	7.2	2.2	2.8	82°	T10	2.5	DIMPLE BAR (☉E007)
	* TS32	3.9	M3×0.5	7.5	2	2.4	60°	T8	2.0	SRM2 (☉K236)
	* TS33	3.9	M3×0.5	6.7	2	2.4	60°	T8	1.5	AQX (☉K186) AJX (☉K194)
	TS35	4.8	M3.5×0.6	6.5	2.4	2.8	60°	T10	2.5	
	* TS35D	5.3	M3.5×0.6	12	2.8	3.4	60°	T15	3.5	HSK System (☉H001)
	★ TS35R	5.7	M3.5×0.6	10	2.1	3.4	—	T15	3.5	AHX440S (☉K034) AHX475S (☉K038)
	TS351	4.8	M3.5×0.6	7.2	2.4	2.8	60°	T10	2.5	AJX (☉K194) SRM2 (☉K236)
	TS352	4.8	M3.5×0.6	10	3	2.8	60°	T10	2.5	VFX5 (☉K208)
	* TS4SB	5.8	M4×0.7	9	2.7	3.4	80°	T15	3.5	AXD7000 (☉K180)
	* TS4SBL	5.8	M4×0.7	10.5	2.7	3.4	80°	T15	3.5	GY Serie (☉F004) AXD7000 (☉K180)
	TS4	5.4	M4×0.7	8	2.6	3.4	60°	T15	3.5	CE/CF/CGSP (☉K246) TSMP (☉K248)
	TS4D	5.6	M4×0.7	7.7	2.5	3.4	82°	T15	3.5	DIMPLE BAR (☉E007)
	TS42	5.4	M4×0.7	6	2.6	3.4	60°	T15	3.5	
	TS43	5.4	M4×0.7	10	2.6	3.4	60°	T15	3.5	AJX (☉K194) BRP (☉K206) SRM2 (☉K236)
	TS44	5.4	M4×0.7	12	2.6	3.4	60°	T15	3.5	
	TS406	5.4	M4×0.7	15.5	2.6	3.4	60°	T15	3.5	
	TS407	5.4	M4×0.7	9	2.6	3.4	60°	T15	3.5	AQX (☉K186) AJX (☉K194)
	TS450	5.9	M4.5×0.75	13	3.6	3.9	60°	T20	5.0	VFX6 (☉K212)
	TS5S	6.8	M5×0.8	9	2.9	4.5	80°	T25	7.5	
	TS5	6.8	M5×0.8	9	3.2	4.5	60°	T25	7.5	SP Halter (☉C024) CE/CF/CGSP (☉K246) TSMP (☉K248)
	TS5L	6.8	M5×0.8	15	2.9	4.5	80°	T25	7.5	
	★ TS5R	6.9	M5×0.8	12	3.5	3.9	—	T20	5.0	WWX400 (☉K067) WJX (☉K085)
	TS52	6.8	M5×0.8	8	3.2	4.5	60°	T25	7.5	CE/CF/CGSP (☉K246)
	TS53	6.8	M5×0.8	16	3.2	4.5	60°	T25	7.5	
	TS54	6.8	M5×0.8	12	3.2	4.5	60°	T25	7.5	AJX (☉K194)
	TS55	6.8	M5×0.8	10.5	3.2	4.5	60°	T25	7.5	GY Serie (☉F004) AQX (☉K186) SPX (☉K219) SRM2 (☉K236)
	* TS6S	8.5	M6×1.0	13	4.4	5.6	60°	T30	10.0	AQX (☉K186) SRM2 (☉K236)
	* TS6	8.5	M6×1.0	16	4.4	5.6	60°	T30	10.0	SRM2 (☉K236)

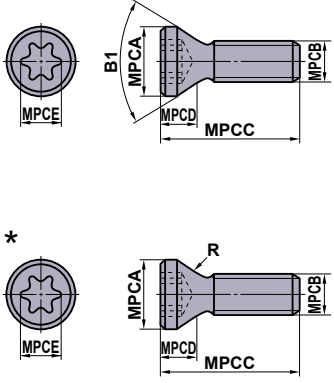
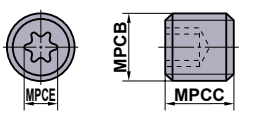
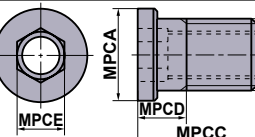
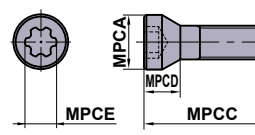
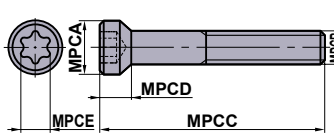
Geometrie	Bestellnummer	Abmessungen (mm)					Winkel	MPCDS	TQ (N·m)	Werkzeughalter
		MPCA	MPCB	MPCD	MPCF	MPCG				
	<b>TPS20-1</b>	2.65	M2×0.4	4.7	2.4	1.8	60°	6IP	0.6	<b>MVX</b> (⊕M158)
	<b>TPS25</b>	3.3	M2.5×0.45	5.5	1.7	2.1	60°	7IP	1.0	<b>APX3000</b> (⊕K146) <b>MVX</b> (⊕M158)
	<b>TPS25-1</b>	3.3	M2.5×0.45	6.5	1.7	2.1	60°	7IP	1.0	<b>APX3000</b> (⊕K146)
	<b>TPS27F1</b>	3.7	M2.7×0.35	6.5	1.8	2.1	60°	7IP	1.0	<b>VPX200</b> (⊕K099)
	<b>TPS27F2</b>	3.7	M2.7×0.35	8.0	1.8	2.1	60°	7IP	1.0	<b>VPX300</b> (⊕K113)
	<b>TPS3</b>	3.9	M3×0.5	6.7	1.4	2.82	60°	10IP	1.0	<b>MVX</b> (⊕M158)
	* <b>TPS3R</b>	4.6	M3×0.5	8.5	1.4	2.82	—	10IP	2.0	<b>WJX09</b> (⊕K085)
	<b>TPS3SB</b>	4.4	M3×0.5	8	2.0	2.82	80°	10IP	3.0	<b>AXD4000A</b> (⊕K176)
	<b>TPS35</b>	5.3	M3.5×0.6	11.5	2.8	3.4	60°	15IP	3.5	<b>ASX445</b> (⊕K026) <b>ASX400</b> (⊕K080) <b>PMR</b> (⊕K252)
	<b>TPS351</b>	4.8	M3.5×0.6	7.2	1.4	2.82	60°	10IP	2.5	<b>MVX</b> (⊕M158)
	<b>TPS351B</b>	5.1	M3.5×0.6	7.2	1.4	2.82	60°	10IP	2.5	<b>ARP</b> (⊕K254)
	<b>TPS4</b>	5.3	M4×0.7	8	2.6	3.4	60°	15IP	3.5	<b>APX4000</b> (⊕K153) <b>ARP</b> (⊕K254) <b>MVX</b> (⊕M158)
	<b>TPS40F1</b>	5.3	M4×0.5	10.5	2.8	3.4	60°	15IP	3.0	<b>VPX300</b> (⊕K113)
	<b>TPS43</b>	5.3	M4×0.7	10	2.6	3.4	60°	15IP	4.0	<b>APX4000</b> (⊕K153) <b>MVX</b> (⊕M158)
	* <b>TPS4R</b>	6.4	M4×0.7	10.6	2.9	3.4	—	15IP	3.5	<b>WSX445</b> (⊕K016)
	<b>TPS54</b>	6.8	M5×0.8	12	3.2	4.5	60°	25IP	7.5	<b>MVX</b> (⊕M158)
	<b>TSS04005</b>	—	M4×0.7	5	—	2.4	—	T8	—	<b>PMF</b> (⊕K250)
	<b>TSS04505S</b>	—	M4.5×0.7	5	—	3.5	—	T10	3.5	<b>FMAX</b> (⊕K056)
	<b>TSS05006</b>	—	M5×0.8	6	—	2.8	—	T10	—	
	<b>TSS06010</b>	—	M6×1	10	—	3.9	—	T20	—	
	<b>WCS503507H</b>	6.3	M5×0.5	7	3.3	3.5	—	—	5.0	<b>ASX445</b> (⊕K026) <b>ASX400</b> (⊕K080) <b>PMR</b> (⊕K252)
	<b>WCS604010H</b>	7.8	M6×0.75	10	4.1	4.0	—	—	7.0	<b>PMR</b> (⊕K252)
	<b>WS203107TPS</b>	3.1	M2×0.25	7.3	1.7	1.8	60°	6IP	1.0	<b>STAW</b> (⊕M139)
	<b>WS203108TPS</b>	3.1	M2×0.25	8.3	1.9	1.8	60°	6IP	1.0	
	<b>WS253909TPS</b>	3.9	M2.5×0.35	9.5	2.4	2.4	60°	8IP	2.0	
	<b>WS304912TPS</b>	4.9	M3×0.35	12	3.25	2.82	60°	10IP	2.5	
	<b>WS254012T</b>	4	M2.5×0.45	11.5	2.2	2.4	80°	T8	2.0	<b>TAW</b> (⊕M148)
	<b>WS254013T</b>	4	M2.5×0.45	12.5	2.2	2.4	80°	T8	2.0	
	<b>WS254014T</b>	4	M2.5×0.45	13.5	2.2	2.4	80°	T8	2.0	
	<b>WS254015T</b>	4	M2.5×0.45	14.5	2.2	2.4	80°	T8	2.0	
	<b>WS254016T</b>	4	M2.5×0.45	15.5	2.2	2.4	80°	T8	2.0	
	<b>WS304517T</b>	4.5	M3×0.5	16.5	3.4	2.8	60°	T10	3.5	
	<b>WS304518T</b>	4.5	M3×0.5	17.5	3.4	2.8	60°	T10	3.5	
	<b>WS355520T</b>	5.5	M3.5×0.6	19.5	3.9	3.4	60°	T15	5.5	
	<b>WS355521T</b>	5.5	M3.5×0.6	20.5	3.9	3.4	60°	T15	5.5	
	<b>WS406023T</b>	6	M4×0.7	22.0	4.4	4.5	60°	T25	8.5	
	<b>WS406024T</b>	6	M4×0.7	23.0	4.4	4.5	60°	T25	8.5	
	<b>WS508026T</b>	8	M5×0.8	25.0	5.2	5.1	60°	T27	12.0	
	<b>WS508027T</b>	8	M5×0.8	26.0	5.2	5.1	60°	T27	12.0	

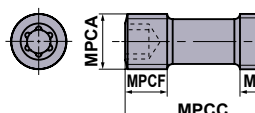
Geometrie	Bestellnummer	Abmessungen (mm)					Winkel	MPCDS	TQ (N·m)	Werkzeughalter
		MPCA	MPCB	MPCD	MPCF	MPCG				
	<b>RX1ST8TP1</b>	M4×0.7	M4×0.5	16.5	7.0	7.0	—	TX8	2.0	<b>RX1S</b> (⊕M197)
	<b>RX1ST10TP23</b>	M5×0.8	M5×0.5	17.0	7.5	7.0	—	TX10	3.0	
	<b>RX1ST15TP45</b>	M6×1.0	M6×0.75	18.0	6.5	8.5	—	TX15	6.5	
	<b>RX1ST25TP6</b>	M10×1.5	M10×1.25	30.0	7.5	9.5	—	TX25	15.0	

# ERSATZTEILE

## SCHRAUBE

ERSATZTEILE

Geometrie	Bestellnummer	Abmessungen (mm)					Winkel	MPCDS	TQ (N·m)	Werkzeughalter
		MPCA	MPCB	MPCC	MPCD	MPCE				
	<b>BOES101</b>	15	M10×1.5	45	10	8	60°	—	10.0	
	* <b>HSC08025H</b>	13	M8×1.25	33	8	5	—	—	24	VPX200/300 (⊕K099,K113) ARP (⊕K254)
	<b>HSC05030</b>	8.5	M5×0.8	35	5	4	—	—	10	APX3000/4000 (⊕K146,K153)
	* <b>HSC08030H</b>	13	M8×1.25	38	8	5	—	—	24	WSX445 (⊕K016)
	<b>HSC08045</b>	13	M8×1.25	53	8	5	—	—	24	VPX200/300 (⊕K099,K113)
	<b>HSC08040</b>	13	M8×1.25	48	8	5	—	—	24	WSX445 (⊕K016)
	<b>HSC08050</b>	13	M8×1.25	58	8	5	—	—	24	VPX200/300 (⊕K099,K113)
	* <b>HSC10030H</b>	16	M10×1.5	40	10	6	—	—	40	APX3000/4000 (⊕K146,K153) AJX (⊕K194) WSX445 (⊕K016)
	<b>HSC10035</b>	16	M10×1.5	45	10	6	—	—	44	VFX5 (⊕K208) VFX6 (⊕K212)
	<b>HSC10050</b>	16	M10×1.5	60	10	8	—	—	44	APX3000/4000 (⊕K146,K153) VPX200/300 (⊕K099,K113)
	<b>HSC10055</b>	16	M10×1.5	65	10	8	—	—	44	VFX5 (⊕K208)
	<b>HSC10060</b>	16	M10×1.5	70	10	8	—	—	44	VPX200/300 (⊕K099,K113)
	<b>HSC10070</b>	16	M10×1.5	80	10	8	—	—	44	VPX200/300 (⊕K099,K113) ASPX (⊕K224)
	<b>HSC12035</b>	18	M12×1.75	47	12	10	—	—	80	WSX445 (⊕K016)
	* <b>HSC12035H</b>	18	M12×1.75	47	12	10	—	—	80	APX3000/4000 (⊕K146,K153) AJX (⊕K194)
	<b>HSC12040</b>	18	M12×1.75	52	12	10	—	—	80	
	<b>HSC12045</b>	18	M12×1.75	57	12	10	—	—	80	WSX445 (⊕K016)
	<b>HSC12060</b>	18	M12×1.75	72	12	10	—	—	80	VPX200/300 (⊕K099,K113)
	<b>HSC12070</b>	18	M12×1.75	82	12	10	—	—	80	APX3000/4000 (⊕K146,K153) AJX (⊕K194) WSX445 (⊕K016)
	<b>HSC16040</b>	24	M16×2	56	16	14	—	—	150	WSX445 (⊕K016)
	* <b>HSC16040H</b>	24	M16×2	56	16	14	—	—	150	APX3000/4000 (⊕K146,K153) AJX (⊕K194)
<b>HSC16055</b>	24	M16×2	71	16	14	—	—	150	VPX200/300 (⊕K099,K113)	
<b>HSC16065</b>	24	M16×2	81	16	14	—	—	150	VPX200/300 (⊕K099,K113)	
<b>HSC16080</b>	24	M16×2	96	16	14	—	—	150		
<b>HSC20040</b>	30	M20×2.5	60	20	17	—	—	320		
<b>HSC20090</b>	30	M20×2.5	110	20	17	—	—	320		
	<b>HSCX12030H</b>	24	M12×1.75	37	7	8	—	—	40	FMAX (⊕K056)
	<b>HSCX16035H</b>	30	M16×2	44	9	12	—	—	100	
	<b>HSCX20035H</b>	36	M20×2.5	46	11	14	—	—	180	
	<b>HFF08033H</b>	11	M8×1.25	33	5	5	90°	—	8.2	WJX09 (⊕K085)
	<b>HFF08043H</b>	11	M8×1.25	43	5	5	90°	—	8.2	AXD4000 (⊕K168)
	<b>MBA16033H</b>	40	M16×2	43	10	14	—	—	150	AHX640 (für Ø100) (⊕K042) WSX445 (⊕K016)
	<b>MBA20040H</b>	50	M20×2.5	54	14	17	—	—	320	APX4000 (⊕K153) AHX475S (⊕K038) AHX640S (⊕K042) AXD4000 (⊕K168) AXD7000 (⊕K180) AJX (⊕K194)

\* Mit Kühlmittelbohrung

Geometrie	Bestellnummer	Abmessungen (mm)						TQ (N·m)	Werkzeughalter
		MPCA	MPCB	MPCC	MPCD	MPCE	MPCF		
	<b>HDS08030</b>	M8×0.75	M8×1.25	30	13.5	11.5	4	8.2	BRP (⊕K206)
	<b>HDS10031</b>	M10×1.0	M10×1.5	31	14	12	5	9.0	PMF (⊕K250)

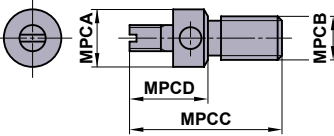

## Große Einstellschraube

Geometrie	Bestellnummer	Abmessungen (mm)					Winkel	MPCDS	TQ (N·m)	Werkzeughalter
		MPCA	MPCB	MPCC	MPCD	MPCE	B1			
	<b>KSS2</b>	6.6	M5×0.8	17.5	9	—	—	—	<b>FMAX</b> (⊕K056)	

## Präzisions-Stellmutter

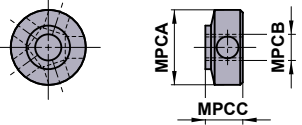
Geometrie	Bestellnummer	Abmessungen (mm)					Winkel	MPCDS	TQ (N·m)	Werkzeughalter
		MPCA	MPCB	MPCC	MPCD	MPCE	B1			
	<b>KSN3</b>	8.6	M3×0.35	4.3	—	—	—	—	<b>FMAX</b> (⊕K056)	

**N**

ERSATZTEILE

# ERSATZTEILE

## UNTERLEGPLATTE

Geometrie	Bestellnummer	Abmessungen (mm)						Werkzeughalter
		MPCA	MPCB	MPCC	MPCD	MPCE	MPCF	
	* PS42	11.46	3.18	0.2	0.2	0.6	1.0	
	* PT21 * PT32 * PT42	5.11 8.28 10.85	2.38 3.18 3.18	0.2 0.2 0.3	0.2 0.2 0.3	0.6 0.6 0.7	— — —	F Bohrstange (☉E029)
	DCSVN32	9.52	3.18	0.8	1.2	—	—	DOPPELKLEMM Halter (☉C019) DIMPLE BAR-BOHRSTANGE (☉E017)
	LLSCN3T3 LLSCN33 LLSCN42 LLSCN53 LLSCN63 * LLSCP42 * LLSCP63	9.52 9.52 12.70 15.87 19.05 12.70 19.05	3.97 4.76 3.18 4.76 4.76 3.18 4.76	0.4 0.4 0.8 1.2 1.2 0.8 1.2	0.4 0.4 0.8 1.2 1.2 0.8 1.2	0.8 0.8 1.2 1.6 1.6 1.2 1.6	0.8 0.8 1.2 1.6 1.6 1.2 1.6	LL Halter (☉C008) LL Halter (☉C008) DIMPLE BAR-BOHRSTANGE (☉E015) P Bohrstange (☉E039) HSK System (☉H001) DIMPLE BAR-BOHRSTANGE (☉E015) P Bohrstange (☉E039) HSK System (☉H001)
	LLSDN32 LLSDN42 LLSDN43 LLSDN53 * LLSDP42	9.52 12.70 12.70 15.87 12.70	3.18 3.18 4.76 4.76 3.18	0.8 0.8 0.8 1.2 0.8	1.2 1.2 1.2 1.6 1.2	— — — — —	— — — — —	DOPPELKLEMM Halter (☉C010) LL Halter (☉C010) DIMPLE BAR-BOHRSTANGE (☉E015) P Bohrstange (☉E039) HSK System (☉H001) DIMPLE BAR-BOHRSTANGE (☉E015)
	LLSRN103 LLSRN123 LLSRN164 LLSRN204 LLSRN326	8.3 9.8 13.6 17.3 28.0	3.18 3.18 4.76 4.76 6.35	— — — — —	— — — — —	— — — — —	— — — — —	LL Halter (☉C026) HSK System (☉H001)
	LLSSN33 LLSSN42 LLSSN53 LLSSN63 LLSSN84 * LLSSP42	9.52 12.70 15.87 19.05 25.40 12.70	4.76 3.18 4.76 4.76 6.35 3.18	0.8 0.8 1.2 1.2 1.6 0.8	0.8 0.8 1.2 1.2 1.6 0.8	1.2 1.2 1.6 1.6 2.4 1.2	1.2 1.6 1.6 2.0 2.4 1.6	DIMPLE BAR-BOHRSTANGE (☉C014) P Bohrstange (☉E038) DIMPLE BAR-BOHRSTANGE (☉E016)
	LLSTE32 LLSTN32 LLSTN33 LLSTN42 LLSTN53 * LLSTP32	7.6 9.52 9.52 12.70 15.87 9.52	3.18 3.18 4.76 3.18 4.76 3.18	0.4 0.4 0.4 0.4 0.8 0.4	0.4 0.8 1.2 1.2 1.6 0.8	0.4 1.2 — — — 1.2	— — — — — —	LL Halter (☉C016) DIMPLE BAR-BOHRSTANGE (☉E016) P Bohrstange (☉E038)
	LLSWN32 LLSWN3T3 LLSWN42 * LLSWP32 * LLSWP42	9.52 9.52 12.70 9.52 12.70	3.18 3.97 3.18 3.18 3.18	0.4 0.4 0.4 0.4 0.4	0.8 0.8 0.8 0.8 0.8	1.2 1.2 1.2 1.2 1.2	— — — — —	LL Halter (☉C022) DOPPELKLEMM Halter (☉C022) DIMPLE BAR-BOHRSTANGE (☉E017)

ERSATZTEILE

N

Geometrie	Bestellnummer	Abmessungen (mm)						Werkzeughalter
		MPCA	MPCB	MPCC	MPCD	MPCE	MPCF	
	<b>MHS532R</b>	9.4	15.7	4.5	0.8	0.8	—	
<p>Die Position der Bohrung liegt außerhalb der Mitte.</p>	<b>MLCP42</b>	12.58	3.18	1.2	1.2	1.2	1.2	P Bohrstange (E039)
<p>Die Position der Bohrung liegt außerhalb der Mitte.</p>	<b>MLDP42</b>	12.56	3.18	1.2	1.2	—	—	P Bohrstange (E039)
<p>Die Position der Bohrung liegt außerhalb der Mitte.</p>	<b>MLSP42</b>	12.63	3.18	1.2	1.2	1.2	1.2	P Bohrstange (E038)
<p>Die Position der Bohrung liegt außerhalb der Mitte.</p>	<b>MLTP32</b>	9.50	3.18	1.2	1.2	1.2	—	P Bohrstange (E038)
	<b>MSCN63</b>	18.8	4.76	1.6	1.6	1.6	1.6	DOPPELKLEMM Halter (C009) (für Schwerzerspannung)
	<b>MSSN63</b>	18.8	4.76	1.6	1.6	1.6	1.6	DOPPELKLEMM Halter (C012) (für Schwerzerspannung)
	* PT32T1R * PT32T2R	8.28 8.28	13.34 13.19	3.18 3.18	— —	— —	— —	
	PV321 PV322 PV323	9.52 9.52 9.52	3.18 3.18 3.18	0.4 0.8 1.2	0.4 0.8 1.2	— — —	— — —	MP Halter (C019)
	<b>SPSVN32</b>	8.06	3.18	0.3	0.3	—	—	SP Halter (C030) HSK System (H001)

# ERSATZTEILE

## UNTERLEGPLATTE

Geometrie	Bestellnummer	Abmessungen (mm)						Werkzeughalter
		MPCA	MPCB	MPCC	MPCD	MPCE	MPCF	
	<b>STASX400N</b>	11.00	3.00	0.4	0.4	0.4	0.4	<b>ASX400</b> (K080)
	<b>STASX445N</b>	10.76	3.00	—	—	—	—	<b>ASX445</b> (K026)
	<b>WPSTN33</b> <b>WPSTN43</b>	9.3 12.50	4.76	0.8	0.4	1.2	—	<b>WP Halter</b> (C017)
	* <b>WPSWC43</b> <b>WPSWN43</b>	12.50 12.50	4.76	0.4	0.8	1.2	—	<b>WP Halter</b> (C023)

ERSATZTEILE

N

## BEFESTIGUNGSFEDER UND KNIEHEBEL

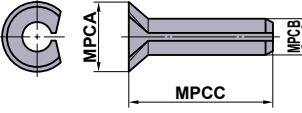
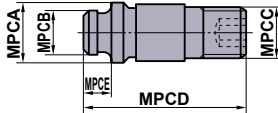
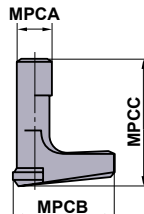
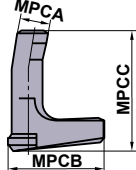
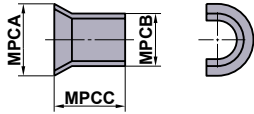
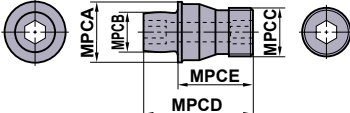
Geometrie	Bestellnummer	Abmessungen (mm)					Werkzeughalter
		MPCA	MPCB	MPCC	MPCD	MPCE	
	<b>BCP141</b>	3.0	1.4	5.6	—	—	<b>SP Halter</b> (☉C030) <b>F Bohrstange</b> (☉E029) <b>HSK System</b> (☉H013)
	<b>BCP201</b>	4.3	2	7.4	—	—	
	<b>BCP202</b>	4.3	2	6.4	—	—	
	<b>CCP33</b>	6.5	3.66	M5×0.8	18.5	3	<b>WP Halter</b> (☉C017)
	<b>CCP34</b>	7.5	5.0	M6×1.0	18.5	3	
	<b>CCP44</b>	7.5	5.0	M5×0.8	14.2	3	
	<b>LLCL12S</b>	2.1	9.3	5.6	—	—	<b>LL Halter</b> (☉C016) <b>P Bohrstange</b> (☉E039) <b>HSK System</b> (☉H001)
	<b>LLCL13</b>	3.6	10	12.5	—	—	
	<b>LLCL13S</b>	3.6	10	7.8	—	—	
	<b>LLCL14</b>	4.7	13.4	13.2	—	—	
	<b>LLCL14S</b>	4.7	13.6	12.2	—	—	
	<b>LLCL15</b>	6.0	19	17	—	—	
	<b>LLCL16</b>	7.5	20.8	21	—	—	
	<b>LLCL18</b>	8.6	25.4	25.2	—	—	
	<b>LLCL23</b>	3.6	12.0	11.5	—	—	
	<b>LLCL23S</b>	3.6	11.6	9.5	—	—	
	<b>LLCL24</b>	4.7	16.2	14.8	—	—	
	<b>LLCL25</b>	6.0	17.1	17	—	—	
	<b>LLCL110</b>	3.0	10.7	11.6	—	—	
	<b>LLCL112</b>	3.5	13	13.5	—	—	
	<b>LLCL116</b>	4.5	18.5	18	—	—	
	<b>LLCL120</b>	5.6	20.3	19	—	—	
	<b>LLCL125</b>	6	24	24	—	—	
	<b>LLCL132</b>	8	30	27	—	—	
	<b>LLP13</b>	5.55	4.85	5.3	—	—	<b>LL Halter</b> (☉C008) <b>DOPPELKLEMM Halter</b> (☉C008) <b>DIMPLE BAR-BOHRSTANGE</b> (☉E015) <b>P Bohrstange</b> (☉E038) <b>HSK System</b> (☉H001)
	<b>LLP14</b>	7.25	6.55	5.8	—	—	
	<b>LLP15</b>	8.8	8.05	8.6	—	—	
	<b>LLP16</b>	10.85	9.85	11.1	—	—	
	<b>LLP18</b>	15.35	13.05	12.0	—	—	
	<b>LLP23</b>	5.55	4.85	6.8	—	—	
	<b>LLP24</b>	7.25	6.55	9.1	—	—	
	<b>MP6</b>	11.9	7.8	M10×1	22.1	15	<b>DOPPELKLEMM Halter</b> (☉C009) (für Schwerzerspannung)

N

ERSATZTEILE

# ERSATZTEILE

## KNIEHEBEL

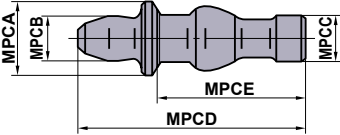
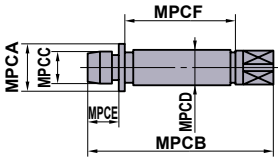
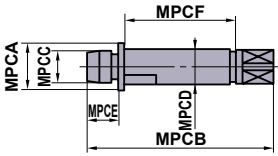
Geometrie	Bestellnummer	Abmessungen (mm)						Werkzeughalter
		MPCA	MPCB	MPCC	MPCD	MPCE	MPCF	
	<b>P11S</b>	6	3.7	4	17	11.1	—	MP Halter (C019)
	<b>P21S</b>	7.5	4.9	4.5	17.2	11.5	—	
	<b>P221US</b>	4	18	2.11	3.5	3.3	7.7	
	<b>P333WS</b>	5.75	24	3.64	5.0	4.9	11.3	
	<b>P434W</b>	7.75	30	5.03	7.0	4.9	16.8	

## SPANNPRATZE

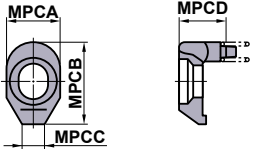
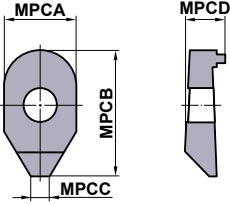
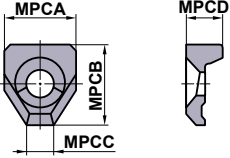
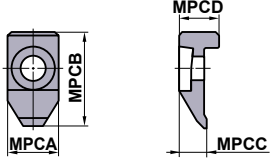
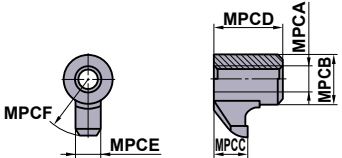
Geometrie	Bestellnummer	Abmessungen (mm)						Werkzeughalter
		MPCA	MPCB	MPCC	MPCD	MPCE	MPCF	
	<b>AMS3</b>	7	12	3	3.3	—	—	Profil Halter (C032) AJX (K196)
	<b>AMS4</b>	9	13.5	3	3.8	—	—	
	<b>AMS5</b>	10	15	3.5	5	—	—	
	<b>CA161</b>	13	20	6	8	—	—	
	<b>CCK13</b>	15	18.5	6	9	—	—	WP Halter (C017)
	<b>CCK14</b>	19	22	8	9.5	—	—	
	<b>CCTC1</b>	13	25	7	10.2	—	—	
	<b>CK231</b>	M6×1	8	4	7.5	4.5	9.5	
	<b>CK232</b>	M6×1	8	4.5	8	4.5	11.5	
	<b>CK341</b>	M8×1	11	5.5	13.5	6	13.5	
	<b>CK342</b>	M8×1	11	6	14	6	16.5	

N

ERSATZTEILE

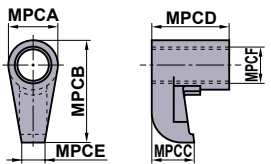
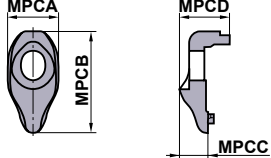
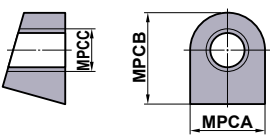
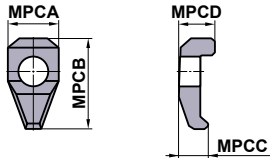
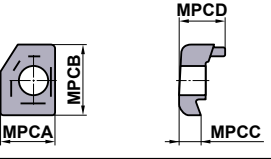
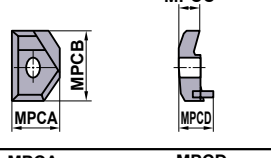
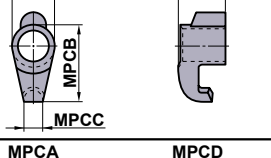
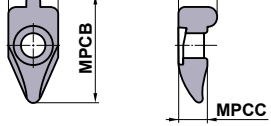
Geometrie	Bestellnummer	Abmessungen (mm)						Werkzeughalter
		MPCA	MPCB	MPCC	MPCD	MPCE	MPCF	
	<b>CKW6</b>	10.9	22.5	9.2	16.8	5	M8×1	<b>DOPPELKLEMM Halter</b> (☉C009) (für Schwerzerspannung)
	<b>DCK2211</b> <b>DCK2613</b> <b>DCK3113</b>	11 13 13	22 26.5 31	6.57 7.35 9	11.1 12.9 14.5	— — —	— — —	<b>DOPPELKLEMM Halter</b> (☉C008) <b>DIMPLE BAR-BOHRSTANGE</b> (☉E015) <b>HSK System</b> (☉H001)
	<b>KGC1</b>	12.0	15.0	M7×0.75	—	—	—	
	<b>LK1</b>	8	14.3	4.5	5.9	—	—	
	<b>MTK1R/L</b>	13	17.5	5	12	—	—	<b>MG Halter</b> (☉F132) <b>MT Halter</b> (☉G024) <b>HSK System</b> (☉H001)
	<b>MTK2R/L</b>	18	28	7	14	—	—	
	<b>SETK51</b> <b>SETK61</b>	6.8 8.9	14.5 18.1	2.9 4.1	8 8.6	— —	— —	<b>MMTE Halter</b> (☉G019) <b>MMTI Halter</b> (☉G026) <b>HSK System</b> (☉H001)
	<b>SRK1R</b>	9.4	21	5.5	7.5	—	—	

**N**

ERSATZTEILE

# ERSATZTEILE

## SPANBRECHER

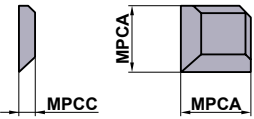
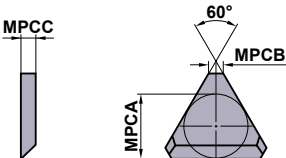
Geometrie	Bestellnummer	Abmessungen (mm)					Werkzeughalter
		MPCA	MPCB	MPCC	IC	LBB	
	<b>CBS3D</b>	8.0	—	1.5	9.525	1.5	
	<b>CBS4D</b>	10.2	—	2.5	12.70	2.5	
	<b>CBT2N</b>	5.67	1.4	1.5	6.35	1.0	<b>F</b> Bohrstange (E029) *Für positive WSP ist die Spanbrecherbreite 0.5mm größer als in der Liste angegeben.
	<b>CBT3F</b>	8.53	1.4	2.5	9.525	1.5	
	<b>CBT4N</b>	11.07	1.4	2.5	12.70	2.5	

N

ERSATZTEILE



# KUPFERPASTEN

## KUPFERPASTEN

Form	Bestellnummer	Lager	Inhalt (g)
	MK1K	★	20
	MK1KS	★	3

N

ERSATZTEILE

★ : Lagerstandard in Japan.

N017

# Notizen

---

A series of horizontal dashed lines for taking notes, spanning the width of the page.

# TECHNISCHE DATEN

ÜBEREINSTIMMUNG MIT ISO13399 .....	P002
STÖRUNGSBESEITIGUNG (BOHREN) .....	P006
BOHRERVERSCHLEISS UND SCHNEIDPLATTENBESCHÄDIGUNG .....	P007
MERKMALE UND SPEZIFIKATIONEN BEIM BOHREN .....	P008
KALKULATIONSFORMELN BOHREN .....	P011
WERKSTOFFVERGLEICHSTABELLE .....	P012
OBERFLÄCHENRAUHIGKEIT .....	P016
HÄRTEVERGLEICHSTABELLE .....	P017
TOLERANZANGABEN FÜR INNENDURCHMESSER (BOHRUNG) .....	P018
ISO-PASSUNGEN EINHEITSWELLE .....	P020
BOHRDURCHMESSER FÜR GEWINDEKERNBOHRUNGEN .....	P022
HEXAGON ZYLINDERSCHRAUBE .....	P023
INTERNATIONAL EINHEITLICHES SYSTEM .....	P024



# ÜBEREINSTIMMUNG MIT ISO13399

## Liste der Eigenschaften nach ISO13399

Alphabetisch

Quelle: Norm ISO13399

URL : <https://www.iso.org/search/x/query/13399>

ISO13399 Eigenschaften	Inhalte
<b>ADJLX</b>	Einstellgrenze maximal
<b>ADJRG</b>	Einstellbereich
<b>ALF</b>	Freiwinkel radial
<b>ALP</b>	Freiwinkel axial
<b>AN</b>	Hauptfreiwinkel
<b>ANN</b>	Hauptfreiwinkel
<b>APMX</b>	Max. Schnitttiefe
<b>AS</b>	Freiwinkel Wiper-Schneide
<b>ASP</b>	Überstand Justierschraube
<b>AZ</b>	Max. Eintauchtiefe
<b>B</b>	Schaftbreite
<b>BBD</b>	Konstruktiv gewuchtete Ausführung
<b>BCH</b>	Fasenslänge Radius
<b>BD</b>	Körperdurchmesser
<b>BDX</b>	Max. Körperdurchmesser
<b>BHCC</b>	Lochkreiszahl
<b>BHTA</b>	Halber Kegeleinstellwinkel
<b>BMC</b>	Bezeichnung Gehäusewerkstoff
<b>BS</b>	Planschneidenbreite
<b>BSR</b>	Wiper-Schneidkantenradius
<b>CASC</b>	Bezeichnung Einsatzgröße
<b>CB</b>	Anzahl der Spanbrecherflächen
<b>CBDP</b>	Anschluss Bohrungstiefe
<b>CBMD</b>	Spanbrecher Herstellerbezeichnung
<b>CBP</b>	Eigenschaft Spanbrecher
<b>CCMS</b>	Anschlusscode maschinenseitig
<b>CCWS</b>	Anschlusscode werkstückseitig
<b>CCP</b>	Eigenschaft Eckfase
<b>CDI</b>	WSP-Schnittdurchmesser
<b>CDX</b>	Max. Stechtiefe
<b>CEATC</b>	Code Winkeltyp Schneidkante
<b>CECC</b>	Code Schneidkantenzustand
<b>CEDC</b>	Anzahl Schneiden
<b>CF</b>	Punktfase
<b>CHW</b>	Eckfasenbreite
<b>CICT</b>	Anzahl Schneidteile
<b>CNC</b>	Anzahl Ecken
<b>CND</b>	Kühlschmierstoffeintritt, Durchmesser
<b>CNSC</b>	Kühlschmierstoffeintritt
<b>CNT</b>	Kühlschmierstoffeintritt, Gewindegröße
<b>CP</b>	Kühlmitteldruck
<b>CRE</b>	Punktradius
<b>CRKS</b>	Gewindegröße des Anzugsbolzens
<b>CSP</b>	Eigenschaft Kühlmittelzufuhr
<b>CTP</b>	Eigenschaft Beschichtung
<b>CTX</b>	Schnittpunktübertragung X-Richtung
<b>CTY</b>	Schnittpunktübertragung Y-Richtung
<b>CUTDIA</b>	Maximaler Werkstückdurchmesser für das Abstechen
<b>CUB</b>	Anschlusseinheit Basis
<b>CW</b>	Stechbreite
<b>CWX</b>	Max. Stechbreite
<b>CXD</b>	Durchmesser Kühlmittelauslass

ISO13399 Eigenschaften	Inhalte
<b>CXSC</b>	Kühlschmierstoffaustritt
<b>CZC</b>	Aufnahmegröße
<b>D1</b>	Durchmesser Befestigungsbohrung
<b>DAH</b>	Durchmesser Zugangsbohrung
<b>DAXN</b>	Min. axialer Stechdurchmesser
<b>DAXX</b>	Max. axialer Stechdurchmesser
<b>DBC</b>	Durchmesser Lochkreis
<b>DC</b>	Schnittdurchmesser
<b>DCB</b>	Spanndurchmesser, nominal, werkstückseitig
<b>DCBN</b>	Spanndurchmesser, min.
<b>DCBX</b>	Spanndurchmesser, max.
<b>DCC</b>	Design-Konfigurationscode
<b>DCCB</b>	Senkbohrung Durchmesser Anschlussbohrung
<b>DCIN</b>	Schnittdurchmesser intern
<b>DCINN</b>	Schnittdurchmesser intern minimal
<b>DCINX</b>	Schnittdurchmesser intern maximal
<b>DCN</b>	Min. Schneiddurchmesser
<b>DCON</b>	Aufnahmedurchmesser, werkstückseitig
<b>DCONMS</b>	Aufnahmedurchmesser maschinenseitig
<b>DCONWS</b>	Aufnahmedurchmesser werkstückseitig
<b>DCSC</b>	Code Schnittdurchmessergröße
<b>DCSFMS</b>	Durchmesser Plananlage maschinenseitig
<b>DCX</b>	Max. Schneiddurchmesser
<b>DF</b>	Flanschdurchmesser
<b>DHUB</b>	Nabendurchmesser
<b>DMIN</b>	Bohrungsdurchmesser, min.
<b>DMM</b>	Schaftdurchmesser
<b>DN</b>	Durchmesser des Freistichs
<b>DRVA</b>	Antriebswinkel
<b>EPSR</b>	Wendeplatten Winkel
<b>FHA</b>	Drallwinkel
<b>FHCSA</b>	Winkel der Senkung der Befestigungsbohrung
<b>FHCSD</b>	Befestigungsloch Senkdurchmesser
<b>FLGT</b>	Flanschdicke
<b>FMT</b>	Gewindeart
<b>FXHLP</b>	Eigenschaft Befestigungsloch
<b>GAMF</b>	Spanwinkel radial
<b>GAMN</b>	Spanwinkel normal
<b>GAMO</b>	Spanwinkel orthogonal
<b>GAMP</b>	Spanwinkel axial
<b>GAN</b>	Spanwinkel
<b>H</b>	Schafthöhe
<b>HA</b>	Gewindehöhe theoretisch
<b>HAND</b>	Richtung
<b>HBH</b>	Kopf Boden Versatzhöhe
<b>HBKL</b>	Kopf Rückseite Versatzlänge
<b>HBKW</b>	Kopf Rückseite Versatzbreite
<b>HBL</b>	Kopf Boden Versatzlänge
<b>HC</b>	Gewindehöhe tatsächlich
<b>HF</b>	Funktionshöhe
<b>HHUB</b>	Nabenhöhe
<b>HTB</b>	Körperhöhe
<b>IC</b>	Einbeschriebener Kreis
<b>IFS</b>	Code WSP-Montageart
<b>IIC</b>	Code WSP-Schnittstelle
<b>INSL</b>	Schneidkantenlänge
<b>KAPR</b>	Einstellwinkel
<b>KCH</b>	Eckfasenwinkel

# TECHNISCHE DATEN

ISO13399 Eigenschaften	Inhalte
<b>KRINS</b>	Winkel der Hauptschneide
<b>KWW</b>	Keilnutbreite
<b>KYP</b>	Eigenschaft der Mitnehmernut
<b>L</b>	Nutzlänge
<b>LAMS</b>	Neigungswinkel
<b>LB</b>	Körperlänge
<b>LBB</b>	Breite Spanbrecher
<b>LBX</b>	Max. Körperlänge
<b>LCCB</b>	Senkbohrung Tiefe Anschlussbohrung
<b>LCF</b>	Spannutlänge
<b>LDRED</b>	Reduzierte Länge Körperdurchmesser
<b>LE</b>	Effektive Länge Schneidkante
<b>LF</b>	Funktionslänge
<b>LFA</b>	Eine Abmessung der Funktionslänge
<b>LH</b>	Kopflänge
<b>LPR</b>	Überstehende Länge
<b>LS</b>	Schaftlänge
<b>LSC</b>	Einspannlänge
<b>LSCN</b>	Min. Einspannlänge
<b>LSCX</b>	Max. Einspannlänge
<b>LTA</b>	LTA-Länge (Länge von MCS zu CRP)
<b>LU</b>	Nutzlänge
<b>LUX</b>	Max. Nutzlänge
<b>M</b>	M-Maß
<b>M2</b>	Abstand zwischen Innenkreisdurchmesser und der Ecke einer Schneidplatte mit sekundärer Winkelangabe
<b>MHA</b>	Winkel Montagebohrung
<b>MHD</b>	Abstand Montageloch
<b>MHH</b>	Höhe Montageloch
<b>MIID</b>	Bezeichnung Schneidplatte
<b>MTP</b>	Code Auflageart
<b>NCE</b>	Anzahl Schnittenden
<b>NOF</b>	Anzahl Schneiden
<b>NOI</b>	Anzahl WSP-Index
<b>NT</b>	Anzahl Zähne
<b>OAH</b>	Gesamthöhe
<b>OAL</b>	Gesamtlänge
<b>OAW</b>	Gesamtbreite
<b>PDPT</b>	Profiltiefe WSP
<b>PDX</b>	Profilabstand ex
<b>PDY</b>	Profilabstand ey
<b>PFS</b>	Code Profilart
<b>PL</b>	Abstand
<b>PNA</b>	Winkelprofil
<b>PRFRAD</b>	Profilradius
<b>PSIR</b>	Hauptschneidenwinkel
<b>PSIRL</b>	Winkel der Hauptschneide Linksausführung
<b>PSIRR</b>	Winkel der Hauptschneide Rechtsausführung
<b>RAL</b>	Freiwinkel Linksausführung
<b>RAR</b>	Freiwinkel Rechtsausführung
<b>RCP</b>	Eigenschaft abgerundete Ecke
<b>RE</b>	Eckenradius
<b>REL</b>	Eckenradius Linksausführung
<b>RER</b>	Eckenradius Rechtsausführung
<b>RMPX</b>	Max. Eintauchwinkel
<b>RPMX</b>	Max. Drehzahl
<b>S</b>	WSP-Stärke
<b>S1</b>	Schneidplattendicke
<b>SC</b>	Schneidplattendicke gesamt
<b>SDL</b>	Stufenlänge
<b>SIG</b>	Spitzenwinkel

ISO13399 Eigenschaften	Inhalte
<b>SSC</b>	Code Plattensitzgröße
<b>SX</b>	Code Querschnittsform des Schafts
<b>TC</b>	WSP Toleranzklasse
<b>TCE</b>	Code bestückte Schneidkante
<b>TCTR</b>	Gewindetoleranzklasse
<b>TD</b>	Gewindenenddurchmesser, metrisch
<b>THFT</b>	Gewindeart
<b>THL</b>	Länge Gewindedrehen
<b>THLGTH</b>	Gewindelänge
<b>THSC</b>	Code Werkzeughalterform
<b>THUB</b>	Nabendicke
<b>TP</b>	Gewindesteigung
<b>TPI</b>	Gewindegänge je Inch
<b>TPIN</b>	Gewindegänge je Inch min.
<b>TPIX</b>	Gewindegänge je Inch max.
<b>TPN</b>	Min. Gewindesteigung
<b>TPT</b>	Gewindeprofiltyp
<b>TPX</b>	Max. Gewindesteigung
<b>TQ</b>	Drehmoment
<b>TSYC</b>	Code für Werkzeugtyp
<b>TTP</b>	Gewindeform
<b>ULDR</b>	Verhältnis Nutzlänge/Durchmesser
<b>UST</b>	Einheitssystem
<b>W1</b>	Breite der Wendeplatte
<b>WEP</b>	Eigenschaft Wiper-Kante
<b>WF</b>	Funktionsbreite
<b>WF2</b>	Abstand zwischen Schnittpunkt der Schneide und des Plattensitzes am Drehhalter
<b>WFS</b>	Funktionsbreite sekundär
<b>WT</b>	Masse
<b>ZEFF</b>	Anzahl wirksamer Schneiden, stirnseitig
<b>ZEFP</b>	Anzahl wirksamer Schneiden, umfangseitig
<b>ZNC</b>	Anzahl Schneidkantenzentren
<b>ZNF</b>	Anzahl stirnseitig montierte WSP
<b>ZNP</b>	Anzahl peripher montierte WSP

## Liste der Referenzsymbole nach ISO13399

ISO13399 Referenzsymbole	Inhalte
<b>CIP</b>	Koordinatensystem in der Bearbeitung
<b>CRP</b>	Schnittreferenzpunkt
<b>CSW</b>	Koordinatensystem werkstückseitig
<b>MCS</b>	Befestigungskoordinatensystem
<b>PCS</b>	Primäres Koordinatensystem

# STÖRUNGSBESEITIGUNG (BOHREN)



TECHNISCHE DATEN

Lösung  Störung  Faktoren		Schnittbedingungen								Art und Design					Maschine Einbau des Werkzeugs							
		Schnittgeschwindigkeit	Vorschub	Geringerer Vorschub beim Anschnitt	Geringerer Vorschub beim Austritt	Gestuftter Vorschub	Präzision der Vorbohrung und Tiefe erhöhen	Kühlung			Querschnittdicke	Fasenbreite	Kerndicke	Nutlänge verringern	Lippenhöhe verringern	Bohrer mit internem Kühlmittel verwenden	Zu Bohrer mit X-Ausspitzung wechseln	Installationspräzision des Werkzeugs erhöhen	Kürzere Auskrägung	Flache Werkstückoberfläche	Klemmsteifigkeit des Werkzeugs erhöhen	Maschinenspiel verringern und Steifigkeit erhöhen
								Höher ↗	Niedriger ↘	Höherer Ölanteil												
				Höher ↗	Niedriger ↘							Höher ↗	Niedriger ↘									
Verkürzung der Werkzeugzeit	Bohrerbruch	Fehlende Bohrersteifigkeit Ungeeignete Schnittbedingungen Starke Ablenkung des Werkzeughalters Werkstückfläche ist angewinkelt		↘								↗	•				•					•
	Starker Verschleiß an der Schneidkantecke und an den Querschnitten	Ungeeignete Schnittbedingungen Erhöhung der Temperatur am Schnittpunkt Unzureichende Rundlauf toleranz	↘				•	•							•		•					
	Bruch der Schneidkantecke	Ungeeignete Schnittbedingungen Starke Ablenkung des Werkzeughalters Rattern, Vibration		↘		•						↘					•				•	•
	Bruch der Querschneide	Querschnittdicke ist zu breit Unzureichender Eintritt Rattern, Vibration			•						↘							•			•	•
Minderung der Bohrlochqualität	Bohrungsdurchmesser wird größer	Fehlende Bohrersteifigkeit Ungeeignete Bohrergeometrie										↗	•	•	•							
	Bohrungsdurchmesser wird kleiner	Erhöhung der Temperatur am Schnittpunkt Ungeeignete Schnittbedingungen Ungeeignete Bohrergeometrie	↘				•	•						•								
	Unzureichende Geradheit	Fehlende Bohrersteifigkeit Starke Ablenkung des Werkzeughalters Unzureichende Führungseigenschaften						•				↗	•	•			•					•
	Unzureichende Präzision der Bohrungsposition, Rundheit und Oberflächenbeschaffenheit	Fehlende Bohrersteifigkeit Unzureichender Eintritt Ungeeignete Schnittbedingungen Starke Ablenkung des Werkzeughalters			•							↗	•	•		•		•				•
Gratbildung	Gratbildung am Bohrungsausgang	Ungeeignete Bohrergeometrie Ungeeignete Schnittbedingungen			•						↘											
Schlechter Spanabfluss	Lange Späne	Ungeeignete Schnittbedingungen Schlechte Späneabfuhr		↗		•						↘			•							
	Spänestau	Ungeeignete Schnittbedingungen Schlechte Späneabfuhr	↘	↘		•						↘			•							



# BOHRERVERSCHLEISS UND SCHNEIDKANTENBESCHÄDIGUNG

## ■ VERSCHLEISSBEDINGUNGEN

Die folgende Tabelle enthält eine einfache Zeichnung, die den Verschleiß der Schneidkante eines Bohrers darstellt. Entstehung und Umfang des Verschleißes variieren in Abhängigkeit von den Werkstückmaterialien und Schnittbedingungen der Anwendung. Im Allgemeinen ist jedoch der periphere Verschleiß am höchsten und bestimmt die Standzeit eines Bohrwerkzeugs. Beim Nachschleifen muss der Flankenverschleiß an der Spitze komplett abgetragen werden. Wenn der Verschleiß hoch ist, muss daher mehr Material entfernt werden, um die Schneidkante wiederherzustellen.

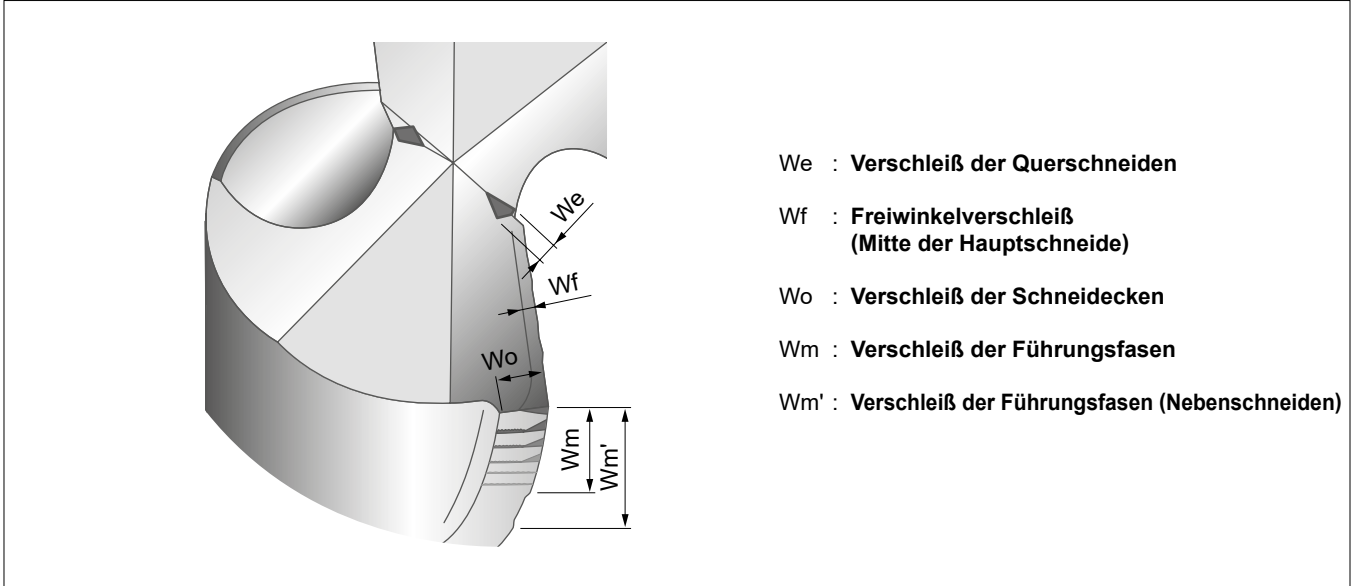

## ■ SCHNEIDKANTENBESCHÄDIGUNG

Beim Bohren kann die Schneidkante durch Spanbildung, Bruch und annormale Beschädigung beeinträchtigt werden. In solchen Fällen ist es wichtig, den Schaden genau zu begutachten, die Ursache zu untersuchen und Gegenmaßnahmen zu ergreifen.

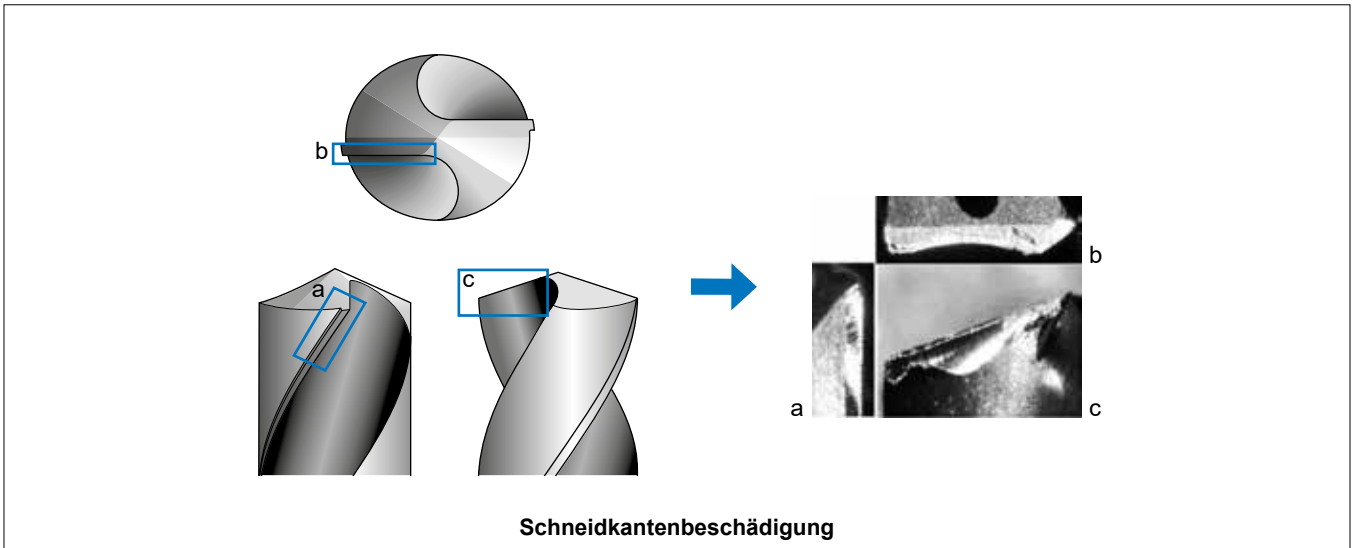

# MERKMALE UND SPEZIFIKATIONEN BEIM BOHREN

## AUSFÜHRUNG

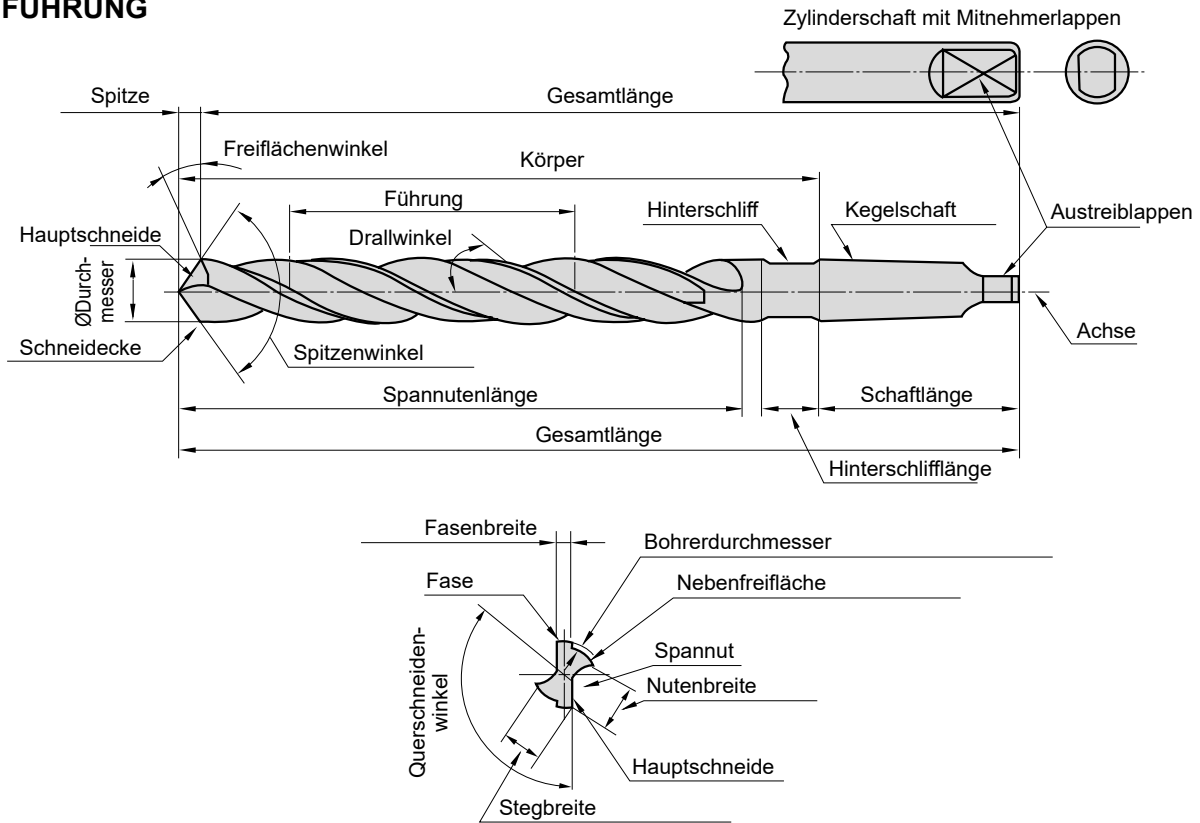

TECHNISCHE DATEN

## FORMEN UND ZERSPANUNGSEIGENSCHAFTEN

Spiralwinkel	Ist der Anstellwinkel der Schneiden im Verhältniss zur Bohrrichtung. Der Neigungswinkel des Bohrers differenziert in Abhängigkeit von der Schneidkantenposition, und er verkleinert sich immens, je näher er zum Zentrum gelangt. <b>Hoch vergütete Materialien Klein ◀• Spanwinkel •▶ Groß Weiches, abrasives Material (Aluminium, usw.)</b>			
Schneidenlänge	Schneidenlänge des Bohrers (z. B. 3xD oder 5xD). Es empfiehlt sich sofern möglich Bohrer mit kurzen Schneiden zu verwenden, um eine hohe Präzision zu gewährleisten.			
Spitzenwinkel	Ein Standard-Spitzenwinkel beträgt 118° und muss in Abstimmung auf verschiedene Anwendungen verändert werden. <b>Weiches Material für gute Bearbeitbarkeit Klein ◀• Spitzenwinkel •▶ Groß Für harte Materialien und Hochleistungsbearbeitung</b>			
Dicke der Ausspreizung	Ein wesentlicher Bestandteil für die Ermittlung der Festigkeit und Spanförderleistung eines Bohrers. Die Trägerstärke ist abhängig von der Anwendung. <table style="width: 100%; border: none;"> <tr> <td style="border: none;">                 Geringer Schnittwiderstand                  Geringe Biegefestigkeit                  Gute Spanabfuhr                  Bearbeitbares Material             </td> <td style="border: none; text-align: center;"> <b>Dünn ◀• Kerndicke, bzw. Dicke der Ausspreizung •▶ Dick</b> </td> <td style="border: none;">                 Hoher Schnittwiderstand                  Hohe Stabilität                  Schlechte Spanabfuhr                  Für gehärtete Materialien, Kreuzlochbohrungen, usw.             </td> </tr> </table>	Geringer Schnittwiderstand Geringe Biegefestigkeit Gute Spanabfuhr Bearbeitbares Material	<b>Dünn ◀• Kerndicke, bzw. Dicke der Ausspreizung •▶ Dick</b>	Hoher Schnittwiderstand Hohe Stabilität Schlechte Spanabfuhr Für gehärtete Materialien, Kreuzlochbohrungen, usw.
Geringer Schnittwiderstand Geringe Biegefestigkeit Gute Spanabfuhr Bearbeitbares Material	<b>Dünn ◀• Kerndicke, bzw. Dicke der Ausspreizung •▶ Dick</b>	Hoher Schnittwiderstand Hohe Stabilität Schlechte Spanabfuhr Für gehärtete Materialien, Kreuzlochbohrungen, usw.		
Führungsfase	Die Fase ermittelt den Bohrdurchmesser und hat eine Führungsfunktion während des Bohrens. <b>Schlechte Führungsleistung Klein ◀• Fase •▶ Groß Gute Führungsleistung</b>			
Verjüngung	Um Reibung innerhalb des Bohrloches zu verringern, ist der Teil von der Spitze bis zum Schaft leicht verjüngt. Dies reduziert zusätzlich den Schnittwiderstand. Der Grad der Verjüngung wird gewöhnlich durch die Herabsetzung des Durchmessers dargestellt, welche ca. 0.04–0.1mm beträgt.			

## ■ DIE SCHNEIDKANTENGEOMETRIE UND IHR EINFLUSS

Wie in der folgenden Tabelle dargestellt, lässt sich die optimale Schneidkantengeometrie für verschiedene Anwendungen auswählen. Wenn die optimale Schneidkantengeometrie zum Einsatz kommt, sind höhere Maschineneffizienz und bessere Bohrungspräzision möglich.

### ● Schneidkanten

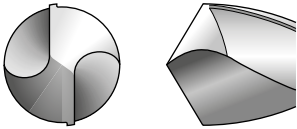
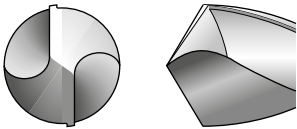
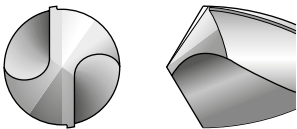
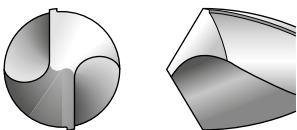
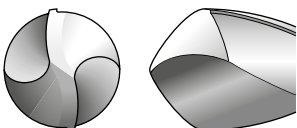
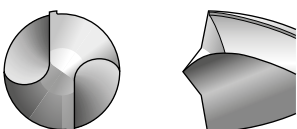
Anschliff	Form	Eigenschaften und Wirkung	Anwendungsgebiet
Konisch		<ul style="list-style-type: none"> <li>Die Flanke ist konisch und der Freiwinkel vergrößert sich zur Bohrermitte.</li> </ul>	<ul style="list-style-type: none"> <li>Allg. Anwendungen</li> </ul>
Flach		<ul style="list-style-type: none"> <li>Die Flanke ist flach.</li> <li>Einfaches Schleifen.</li> </ul>	<ul style="list-style-type: none"> <li>Hauptsächlich für Bohrer mit kleinem Durchmesser.</li> </ul>
Dreistufiger Winkel		<ul style="list-style-type: none"> <li>Aufgrund der fehlenden Querschneidenkante kommt es zu hoher Zentripetalkraft und Überdimensionierung kleiner Bohrungen.</li> <li>Erfordert eine Spezialschleifmaschine.</li> <li>Planschleifen von drei Seiten.</li> </ul>	<ul style="list-style-type: none"> <li>Für Bohrungen, die eine hohe Bohrungspräzision und Positionierungsgenauigkeit erfordern.</li> </ul>
Spiralpunkt		<ul style="list-style-type: none"> <li>Um den Freiwinkel in der Nähe der Bohrungsmitte zu erhöhen, wird Kegelschleifen mit unregelmäßigem Drall kombiniert.</li> <li>S-Querschneidenkante mit hoher Zentripetalkraft und Bearbeitungspräzision.</li> </ul>	<ul style="list-style-type: none"> <li>Für Bohrungen, die eine hohe Präzision erfordern.</li> </ul>
Radiallippe		<ul style="list-style-type: none"> <li>Die Schneidkante wird radial geschliffen, um die Last zu verteilen.</li> <li>Hohe Bohrlochpräzision und Oberflächengüte.</li> <li>Bei Durchgangsbohrungen kleine Grate an der Basis.</li> <li>Erfordert eine Spezialschleifmaschine.</li> </ul>	<ul style="list-style-type: none"> <li>Gusseisen, Aluminiumleg.</li> <li>Für Gusseisenplatten</li> <li>Stahl</li> </ul>
Mittelpunktbohrung		<ul style="list-style-type: none"> <li>Diese Geometrie weist einen zweistufigen Keilwinkel auf, der eine bessere Zentrierung und eine Verringerung der Schnittkräfte beim Austritt aus dem Werkstück gewährleistet.</li> </ul>	<ul style="list-style-type: none"> <li>Für Dünnschleifbohrungen</li> </ul>







## ■ AUSSPITZUNG

Der Neigungswinkel der Bohrer Schneidkante wird kleiner, je näher er sich dem Zentrum bewegt, er wird negativ an der Bohrkante. Beim Bohren zerdrückt das Zentrum des Bohrers das Material, indem er 50–70% des Zerspanungswiderstandes erzeugt. Die Ausspreizung ist für die Reduzierung des Schnittwiderstandes eines Bohrers sehr effektiv, frühe Beseitigung der Späne an der Bohrkante und bessere Schnittleistung.

Form	X TYP	XR TYP	S TYP	N TYP
Eigenschaften	Die Schubkraft reduziert sich und die Schnittleistung verbessert sich. Effektiv wenn die Ausspreizung vergleichsweise dick ist.	Die Schnittleistung ist gegenüber der X-Ausführung minderwertig, jedoch ist die Schneidkante hart und der Anwendungsbereich groß.	Leichtes Schneiden. Gebräuchliche Form.	Effektiv, wenn die Ausspreizung vergleichsweise dick ist.
Haupt Anwendungsbereiche	Allg. Bohren und Tieflochbohren.	Lange Standzeit. Allg. Bohren und Bohren von rostfreiem Stahl.	Bohren für Stahl, Gusseisen und Nicht-Eisen-Metalle.	Tieflochbohren.

# MERKMALE UND SPEZIFIKATIONEN BEIM BOHREN

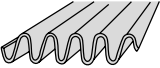
## ■ SPANBILDUNG BEIM BOHREN

Spanformen	Form	Merkmale und Entstehung
Spirale		Lüftungsgeformte Späne, die durch Schnitte an der Schneidkante entstehen, sind durch die Spannutt gebogen. Späne dieser Art entstehen, wenn duktiler Guss mit niedriger Vorschubgeschwindigkeit gebohrt wird. Wenn der Span nach mehrmaligen Umdrehungen bricht, ist die Spanleistung zufriedenstellend.
Reisspan		Lange Späne werden ohne Aufwickelungen abgeführt. Verwicklungen um den Bohrer herum sind leicht möglich.
Halbschale		Dies ist ein Span, der durch die Bohrnut und Wand des Bohrloches gebrochen wurde. Dies wird erzeugt bei hohem Vorschub.
Fahne		Ein konisch gewundener Span der gebrochen ist, bevor er eine lange Form erhält. Die Wand des Bohrloches zeigt unzureichendes Dehnungsvermögen. Exzellente Späneförderung und Spanabfuhr.
Zickzack		Ein verwickelter Span entsteht durch die Nutenform und die Materialeigenschaften. Es wird leicht ein Spänestau an der Nut verursacht.
Nadeln		Spanbruch durch Vibrationen oder durch sprödes Material bei kleinem Radius. Die ansteigende Leistung ist vergleichsweise befriedigend, aber diese Späne können eng gepackt werden.

# KALKULATIONSFORMELN BOHREN

## ■ SCHNITTGESCHWINDIGKEIT ( $V_c$ )

$$V_c = \frac{\pi \cdot DC \cdot n}{1000} \text{ (m/min)}$$

$V_c$  (m/min): Schnittgeschwindigkeit     $DC$  (mm) : Bohrerdurchmesser  
 $\pi$  (3.14) : Pi     $n$  (U/min) : Hauptspindeldrehzahl

\*Teilen Sie durch 1000, um von Meter zu Millimeter zu wechseln.

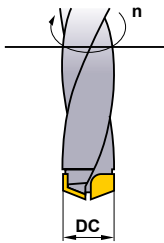

(Beispiel) Wie hoch ist die Schnittgeschwindigkeit wenn die Geschwindigkeit der Spindelachse 1350U/min und der Bohrdurchmesser 12mm beträgt ?

(Lösung) Setzen Sie  $\pi=3.14$ ,  $DC=12$ ,  $n=1350$  in die Formel.

$$V_c = \frac{\pi \cdot DC \cdot n}{1000} = \frac{3.14 \times 12 \times 1350}{1000} = 50.9 \text{ m/min}$$

Die Schnittgeschwindigkeit beträgt 50.9m/min.

## ■ VORSCHUB DER HAUPTSPINDEL ( $V_f$ )

$$V_f = fr \cdot n \text{ (mm/min)}$$

$V_f$  (mm/min) : Vorschubgeschwindigkeit der Hauptspindel (Z-achse)  
 $fr$  (mm/U.) : Vorschub pro Umdrehung  
 $n$  (U/min) : Hauptspindeldrehzahl

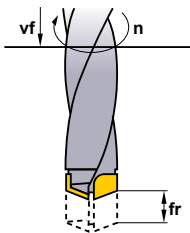

(Beispiel) Wie hoch ist der Spindelvorschub ( $V_f$ ) bei einer Drehzahl von 0.2mm/U. und der Hauptspindelvorschub 1350U/min beträgt?

(Lösung) Setzen Sie  $fr=0.2$ ,  $n=1350$  in die Formel.

$$V_f = fr \cdot n = 0.2 \times 1350 = 270 \text{ mm/min}$$

Der Spindelvorschub =  $V_c$  270mm/min.

## ■ BEARBEITUNGSZEIT ( $T_c$ )

$$T_c = \frac{ld \cdot i}{n \cdot fr}$$

$T_c$  (min) : Bearbeitungszeit  
 $n$  (U/min) : Drehzahl  
 $ld$  (mm) : Bohrungstiefe  
 $fr$  (mm/U.) : Vorschub pro Umdrehung  
 $i$  : Anzahl Bohrungen

(Beispiel) Ermitteln Sie die benötigte Bearbeitungszeit für eine Bohrungstiefe von 30mm in Stahl bei einer Schnittgeschw. Von  $V_c$  50m/min. und einem Vorschub von  $f$  0.15mm/U.

(Lösung) Drehzahl  $n = \frac{50 \times 1000}{15 \times 3.14} = 1061.57 \text{ U/min}$

$$T_c = \frac{30 \times 1}{1061.57 \times 0.15} = 0.188$$

$$= 0.188 \times 60 \approx 11.3 \text{ sec}$$

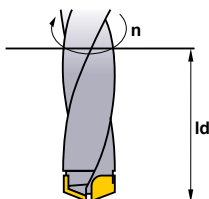

: Hauptspindeldrehzahl

# WERKSTOFFVERGLEICHSTABELLE

## ■ C-STAHL

Deutschland		U.K.		Frankreich	Italien	Spanien	Schweden	Japan	USA	China
W-nr.	DIN	BS	EN	AFNOR	UNI	UNE	SS	JIS	AISI/SAE	GB
1.0038	RSt.37-2	4360 40 C	–	E 24-2 Ne	–	–	1311	STKM 12A STKM 12C	A570.36	15
1.0401	C15	080M15	–	CC12	C15, C16	F.111	1350	–	1015	15
1.0402	C22	050A20	2C	CC20	C20, C21	F.112	1450	–	1020	20
1.0715	9SMn28	230M07	1A	S250	CF9SMn28	F.2111 11SMn28	1912	SUM22	1213	Y15
1.0718	9SMnPb28	–	–	S250Pb	CF9SMnPb28	11SMnPb28	1914	SUM22L	12L13	–
1.0722	10SPb20	–	–	10PbF2	CF10Pb20	10SPb20	–	–	–	–
1.0736	9SMn36	240M07	1B	S300	CF9SMn36	12SMn35	–	–	1215	Y13
1.0737	9SMnPb36	–	–	S300Pb	CF9SMnPb36	12SMnP35	1926	–	12L14	–
1.1141	Ck15	080M15	32C	XC12	C16	C15K	1370	S15C	1015	15
1.1158	Ck25	–	–	–	–	–	–	S25C	1025	25
1.8900	StE380	4360 55 E	–	–	FeE390KG	–	2145	–	A572-60	–
1.0501	C35	060A35	–	CC35	C35	F.113	1550	–	1035	35
1.0503	C45	080M46	–	CC45	C45	F.114	1650	–	1045	45
1.0726	35S20	212M36	8M	35MF4	–	F210G	1957	–	1140	–
1.1157	40Mn4	150M36	15	35M5	–	–	–	–	1039	40Mn
1.1167	36Mn5	–	–	40M5	–	36Mn5	2120	SMn438(H)	1335	35Mn2
1.1170	28Mn6	150M28	14A	20M5	C28Mn	–	–	SCMn1	1330	30Mn
1.1183	Cf35	060A35	–	XC38TS	C36	–	1572	S35C	1035	35Mn
1.1191	Ck45	080M46	–	XC42	C45	C45K	1672	S45C	1045	Ck45
1.1213	C50	060A52	–	XC48TS	C53	–	1674	S50C	1050	50
1.0535	C55	070M55	9	–	C55	–	1655	–	1055	55
1.0601	C60	080A62	43D	CC55	C60	–	–	–	1060	60
1.1203	Ck55	070M55	–	XC55	C50	C55K	–	S55C	1055	55
1.1221	Ck60	080A62	43D	XC60	C60	–	1678	S58C	1060	60Mn
1.1274	Ck101	060A96	–	XC100	–	F.5117	1870	–	1095	–
1.1545	C105W1	BW1A	–	Y105	C36KU	F.5118	1880	SK3	W1	–
1.1545	C105W1	BW2	–	Y120	C120KU	F.515	2900	SUP4	W210	–

## ■ LEG. STAHL

Deutschland		U.K.		Frankreich	Italien	Spanien	Schweden	Japan	USA	China
W-nr.	DIN	BS	EN	AFNOR	UNI	UNE	SS	JIS	AISI/SAE	GB
1.0144	St.44.2	4360 43 C	–	E28-3	–	–	1412	SM400A, SM400B SM400C	A573-81	–
1.0570	St52-3	4360 50 B	–	E36-3	Fe52BFN Fe52CFN	–	2132	SM490A, SM490B SM490C	–	–
1.0841	St52-3	150M19	–	20MC5	Fe52	F.431	2172	–	5120	–
1.0904	55Si7	250A53	45	55S7	55Si8	56Si7	2085	–	9255	55Si2Mn
1.0961	60SiCr7	–	–	60SC7	60SiCr8	60SiCr8	–	–	9262	–
1.3505	100Cr6	534A99	31	100C6	100Cr6	F.131	2258	SUJ2	ASTM 52100	Gr15, 45G
1.5415	15Mo3	1501-240	–	15D3	16Mo3KW	16Mo3	2912	–	ASTM A204Gr.A	–
1.5423	16Mo5	1503-245-420	–	–	16Mo5	16Mo5	–	–	4520	–
1.5622	14Ni6	–	–	16N6	14Ni6	15Ni6	–	–	ASTM A350LF5	–
1.5662	X8Ni9	1501-509-510	–	–	X10Ni9	XBNI09	–	–	ASTM A353	–
1.5710	36NiCr6	640A35	111A	35NC6	–	–	–	SNC236	3135	–
1.5732	14NiCr10	–	–	14NC11	16NiCr11	15NiCr11	–	SNC415(H)	3415	–
1.5752	14NiCr14	655M13	36A	12NC15	–	–	–	SNC815(H)	3415, 3310	–
1.6523	21NiCrMo2	805M20	362	20NCD2	20NiCrMo2	20NiCrMo2	2506	SNCM220(H)	8620	–
1.6546	40NiCrMo22	311-Type 7	–	–	40NiCrMo2(KB)	40NiCrMo2	–	SNCM240	8740	–
1.6587	17CrNiMo6	820A16	–	18NCD6	–	14NiCrMo13	–	–	–	–
1.7015	15Cr3	523M15	–	12C3	–	–	–	SCr415(H)	5015	15Cr

Deutschland		U.K.		Frankreich	Italien	Spanien	Schweden	Japan	USA	China
W-nr.	DIN	BS	EN	AFNOR	UNI	UNE	SS	JIS	AISI/SAE	GB
1.7045	42Cr4	–	–	–	–	42Cr4	2245	SCr440	5140	40Cr
1.7176	55Cr3	527A60	48	55C3	–	–	–	SUP9(A)	5155	20CrMn
1.7262	15CrMo5	–	–	12CD4	–	12CrMo4	2216	SCM415(H)	–	–
1.7335	13CrMo4 4	1501-620Gr27	–	15CD3.5 15CD4.5	14CrMo45	14CrMo45	–	–	ASTM A182 F11, F12	–
1.7380	10CrMo910	1501-622 Gr31, 45	–	12CD9 12CD10	12CrMo9 12CrMo10	TU.H	2218	–	ASTM A182 F.22	–
1.7715	14MoV63	1503-660-440	–	–	–	13MoCrV6	–	–	–	–
1.8523	39CrMoV13 9	897M39	40C	–	36CrMoV12	–	–	–	–	–
1.6511	36CrNiMo4	816M40	110	40NCD3	38NiCrMo4(KB)	35NiCrMo4	–	–	9840	–
1.6582	34CrNiMo6	817M40	24	35NCD6	35NiCrMo6(KB)	–	2541	–	4340	40CrNiMoA
1.7033	34Cr4	530A32	18B	32C4	34Cr4(KB)	35Cr4	–	SCr430(H)	5132	35Cr
1.7035	41Cr4	530M40	18	42C4	41Cr4	42Cr4	–	SCr440(H)	5140	40Cr
1.7131	16MnCr5	(527M20)	–	16MC5	16MnCr5	16MnCr5	2511	–	5115	18CrMn
1.7218	25CrMo4	1717CDS110 708M20	–	25CD4	25CrMo4(KB)	55Cr3	2225	SCM420 SCM430	4130	30CrMn
1.7220	34CrMo4	708A37	19B	35CD4	35CrMo4	34CrMo4	2234	SCM432 SCCRM3	4137 4135	35CrMo
1.7223	41CrMo4	708M40	19A	42CD4TS	41CrMo4	42CrMo4	2244	SCM 440	4140 4142	40CrMoA
1.7225	42CrMo4	708M40	19A	42CD4	42CrMo4	42CrMo4	2244	SCM440(H)	4140	42CrMo 42CrMnMo
1.7361	32CrMo12	722M24	40B	30CD12	32CrMo12	F.124.A	2240	–	–	–
1.8159	50CrV4	735A50	47	50CV4	50CrV4	51CrV4	2230	SUP10	6150	50CrVA
1.8509	41CrAlMo7	905M39	41B	40CAD6 40CAD2	41CrAlMo7	41CrAlMo7	2940	–	–	–
1.2067	100Cr6	BL3	–	Y100C6	–	100Cr6	–	–	L3	CrV, 9SiCr
1.2419	105WCr6	–	–	105WC13	100WCr6 107WCr5KU	105WCr5	2140	SKS31 SKS2, SKS3	–	CrWMo
1.2713	55NiCrMoV6	BH224/5	–	55NCDV7	–	F.520.S	–	SKT4	L6	5CrNiMo
1.5662	X8Ni9	1501-509	–	–	X10Ni9	XBNI09	–	–	ASTM A353	–
1.5680	12Ni19	–	–	Z18N5	–	–	–	–	2515	–
1.6657	14NiCrMo134	832M13	36C	–	15NiCrMo13	14NiCrMo131	–	–	–	–
1.2080	X210Cr12	BD3	–	Z200C12	X210Cr13KU X250Cr12KU	X210Cr12	–	SKD1	D3 ASTM D3	Cr12
1.2601	X153CrMoV12	BD2	–	–	X160CrMoV12	–	–	SKD11	D2	Cr12MoV
1.2363	X100CrMoV5	BA2	–	Z100CDV5	X100CrMoV5	F.5227	2260	SKD12	A2	Cr5Mo1V
1.2344	X40CrMoV51 X40CrMoV51	BH13	–	Z40CDV5	X35CrMoV05KU X40CrMoV51KU	X40CrMoV5	2242	SKD61	H13 ASTM H13	40CrMoV5
1.2436	X210CrW12	–	–	–	X215CrW121KU	X210CrW12	2312	SKD2	–	–
1.2542	45WCrV7	BS1	–	–	45WCrV8KU	45WCrSi8	2710	–	S1	–
1.2581	X30WCrV93	BH21	–	Z30WCV9	X28W09KU	X30WCrV9	–	SKD5	H21	30WCrV9
1.2601	X165CrMoV12	–	–	–	X165CrMoV12KU	X160CrMoV12	2310	–	–	–
1.2833	100V1	BW2	–	Y1105V	–	–	–	SKS43	W210	V
1.3255	S 18-1-2-5	BT4	–	Z80WKCV	X78WCo1805KU	HS18-1-1-5	–	SKH3	T4	W18Cr4VCo5
1.3355	S 18-0-1	BT1	–	Z80WCV	X75W18KU	HS18-0-1	–	SKH2	T1	–
1.3401	G-X120Mn12	Z120M12	–	Z120M12	XG120Mn12	X120MN12	–	SCMnH/1	–	–
1.4718	X45CrSi93	401S45	52	Z45CS9	X45CrSi8	F.322	–	SUH1	HW3	X45CrSi93
1.3343	S6-5-2	4959BA2	–	Z40CSD10	15NiCrMo13	–	2715	SUH3	D3	–
1.3343	S6/5/2	BM2	–	Z85WDCV	HS6-5-2-2	F.5603	2722	SKH9, SKH51	M2	–
1.3348	S 2-9-2	–	–	–	HS2-9-2	HS2-9-2	2782	–	M7	–
1.3243	S6/5/2/5	BM35	–	6-5-2-5	HS6-5-2-5	F.5613	2723	SKH55	M35	–

# WERKSTOFFVERGLEICHSTABELLE

## ■ ROSTFREIER STAHL (FERRITISCH, MARTENSITISCH)

Deutschland		U.K.		Frankreich	Italien	Spanien	Schweden	Japan	USA	China
W-nr.	DIN	BS	EN	AFNOR	UNI	UNE	SS	JIS	AISI/SAE	GB
1.4000	X7Cr13	403S17	–	Z6C13	X6Cr13	F.3110	2301	SUS403	403	OCr13 1Cr12
1.4001	X7Cr14	–	–	–	–	F.8401	–	–	–	–
1.4005	X12CrS13	416S21	–	Z11CF13	X12CrS13	F.3411	2380	SUS416	416	–
1.4006	X10Cr13	410S21	56A	Z10C14	X12Cr13	F.3401	2302	SUS410	410	1Cr13
1.4016	X8Cr17	430S15	60	Z8C17	X8Cr17	F.3113	2320	SUS430	430	1Cr17
1.4027	G-X20Cr14	420C29	56B	Z20C13M	–	–	–	SCS2	–	–
1.4034	X46Cr13	420S45	56D	Z40CM Z38C13M	X40Cr14	F.3405	2304	SUS420J2	–	4Cr13
1.4003	–	405S17	–	Z8CA12	X6CrAl13	–	–	–	405	–
1.4021	–	420S37	–	Z8CA12	X20Cr13	–	2303	–	420	–
1.4057	X22CrNi17	431S29	57	Z15CNi6.02	X16CrNi16	F.3427	2321	SUS431	431	1Cr17Ni2
1.4104	X12CrMoS17	–	–	Z10CF17	X10CrS17	F.3117	2383	SUS430F	430F	Y1Cr17
1.4113	X6CrMo17	434S17	–	Z8CD17.01	X8CrMo17	–	2325	SUS434	434	1Cr17Mo
1.4313	X5CrNi134	425C11	–	Z4CND13.4M	(G)X6CrNi304	–	2385	SCS5	CA6-NM	–
1.4724	X10CrA113	403S17	–	Z10C13	X10CrA112	F.311	–	SUS405	405	OCr13Al
1.4742	X10CrA118	430S15	60	Z10CAS18	X8Cr17	F.3113	–	SUS430	430	Cr17
1.4747	X80CrNiSi20	443S65	59	Z80CSN20.02	X80CrSiNi20	F.320B	–	SUH4	HNV6	–
1.4762	X10CrA124	–	–	Z10CAS24	X16Cr26	–	2322	SUH446	446	2Cr25N
1.4871	X53CrMnNiN219	349S54	–	Z52CMN21.09	X53CrMnNiN219	–	–	SUH35	EV8	5Cr2Mn9Ni4N
1.4521	X1CrMoTi182	–	–	–	–	–	2326	–	S44400	–
1.4922	X20CrMoV12-1	–	–	–	X20CrMoNi1201	–	2317	–	–	–
1.4542	–	–	–	Z7CNU17-04	–	–	–	–	630	–

## ■ ROSTFREIER STAHL (AUSTENITISCH)

Deutschland		U.K.		Frankreich	Italien	Spanien	Schweden	Japan	USA	China
W-nr.	DIN	BS	EN	AFNOR	UNI	UNE	SS	JIS	AISI/SAE	GB
1.4306	X2CrNi1911	304S11	–	Z2CN18.10	X2CrNi18.11	–	2352	SUS304L	304L	OCr19Ni10
1.4350	X5CrNi189	304S11	58E	Z6CN18.09	X5CrNi1810	F.3551 F.3541 F.3504	2332	SUS304	304	OCr18Ni9
1.4305	X12CrNiS188	303S21	58M	Z10CNF18.09	X10CrNiS18.09	F.3508	2346	SUS303	303	1Cr18Ni9MoZr
–	–	304C12	–	Z3CN19.10	–	–	2333	SUS304L	–	–
1.4306	X2CrNi189	304S12	–	Z2CrNi1810	X2CrNi18.11	F.3503	2352	SCS19	304L	–
1.4310	X12CrNi177	–	–	Z12CN17.07	X12CrNi1707	F.3517	2331	SUS301	301	Cr17Ni7
1.4311	X2CrNiN1810	304S62	–	Z2CN18.10	–	–	2371	SUS304LN	304LN	–
1.4401	X5CrNiMo1810	316S16	58J	Z6CND17.11	X5CrNiMo1712	F.3543	2347	SUS316	316	OCr17Ni11Mo2
1.4308	G-X6CrNi189	304C15	–	Z6CN18.10M	–	–	–	SCS13	–	–
1.4408	G-X6CrNiMo1810	316C16	–	–	–	F.8414	–	SCS14	–	–
1.4581	G-X5CrNiMoNb1810	318C17	–	Z4CNDNb1812M	XG8CrNiMo1811	–	–	SCS22	–	–
1.4429	X2CrNiMoN1813	–	–	Z2CND17.13	–	–	2375	SUS316LN	316LN	OCr17Ni13Mo
1.4404	–	316S13	–	Z2CND17.12	X2CrNiMo1712	–	2348	–	316L	–
1.4435	X2CrNiMo1812	316S13	–	Z2CND17.12	X2CrNiMo1712	–	2353	SCS16 SUS316L	316L	OCr27Ni12Mo3
1.4436	–	316S13	–	Z6CND18-12-03	X8CrNiMo1713	–	2343, 2347	–	316	–
1.4438	X2CrNiMo1816	317S12	–	Z2CND19.15	X2CrNiMo1816	–	2367	SUS317L	317L	OCr19Ni13Mo
1.4539	X1NiCrMo	–	–	Z6CNT18.10	–	–	2562	–	UNS V 0890A	–
1.4541	X10CrNiTi189	321S12	58B	Z6CNT18.10	X6CrNiTi1811	F.3553 F.3523	2337	SUS321	321	1Cr18Ni9Ti
1.4550	X10CrNiNb189	347S17	58F	Z6CNNb18.10	X6CrNiNb1811	F.3552 F.3524	2338	SUS347	347	1Cr18Ni11Nb
1.4571	X10CrNiMoTi1810	320S17	58J	Z6CNDT17.12	X6CrNiMoTi1712	F.3535	2350	–	316Ti	Cr18Ni12Mo2T
1.4583	X10CrNiMoNb1812	–	–	Z6CNDNb1713B	X6CrNiMoNb1713	–	–	–	318	Cr17Ni12Mo3Mb



Deutschland		U.K.		Frankreich	Italien	Spanien	Schweden	Japan	USA	China
W-nr.	DIN	BS	EN	AFNOR	UNI	UNE	SS	JIS	AISI/SAE	GB
1.4828	X15CrNiSi2012	309S24	–	Z15CNS20.12	X6CrNi2520	–	–	SUH309	309	1Cr23Ni13
1.4845	X12CrNi2521	310S24	–	Z12CN2520	X6CrNi2520	F.331	2361	SUH310	310S	OCr25Ni20
1.4406	X10CrNi18.08	–	58C	Z1NCDU25.20	–	F.8414	2370	SCS17	308	–
1.4418	X4CrNiMo165	–	–	Z6CND16-04-01	–	–	–	–	–	–
1.4568	–	316S111	–	Z8CNA17-07	X2CrNiMo1712	–	–	–	17-7PH	–
1.4504	–	–	–	–	–	–	–	–	–	–
1.4563	–	–	–	Z1NCDU31-27-03 Z1CNDU20-18-06AZ	–	–	2584 2378	–	NO8028 S31254	–
1.4878	X12CrNiTi189	321S32	58B, 58C	Z6CNT18.12B	X6CrNiTi18.11	F.3523	–	SUS321	321	1Cr18Ni9Ti

### ■ HITZEBESTÄNDIGE STÄHLE

Deutschland		U.K.		Frankreich	Italien	Spanien	Schweden	Japan	USA	China
W-nr.	DIN	BS	EN	AFNOR	UNI	UNE	SS	JIS	AISI/SAE	GB
1.4864	X12NiCrSi3616	–	–	Z12NCS35.16	–	–	–	SUH330	330	–
1.4865	G-X40NiCrSi3818	330C11	–	–	XG50NiCr3919	–	–	SCH15	HT, HT 50	–

### ■ GRAUGUSS

Deutschland		U.K.		Frankreich	Italien	Spanien	Schweden	Japan	USA	China
W-nr.	DIN	BS	EN	AFNOR	UNI	UNE	SS	JIS	AISI/SAE	GB
–	–	–	–	–	–	–	0100	–	–	–
–	GG 10	–	–	Ft 10 D	–	–	0110	FC100	No 20 B	–
0.6015	GG 15	Grade 150	–	Ft 15 D	G15	FG15	0115	FC150	No 25 B	HT150
0.6020	GG 20	Grade 220	–	Ft 20 D	G20	–	0120	FC200	No 30 B	HT200
0.6025	GG 25	Grade 260	–	Ft 25 D	G25	FG25	0125	FC250	No 35 B	HT250
–	–	–	–	–	–	–	–	–	No 40 B	–
0.6030	GG 30	Grade 300	–	Ft 30 D	G30	FG30	0130	FC300	No 45 B	HT300
0.6035	GG 35	Grade 350	–	Ft 35 D	G35	FG35	0135	FC350	No 50 B	HT350
0.6040	GG 40	Grade 400	–	Ft 40 D	–	–	0140	–	No 55 B	HT400
0.6660	GGL NiCr202	L-NiCuCr202	–	L-NC 202	–	–	0523	–	A436 Type 2	–

### ■ DUKTILER GUSS

Deutschland		U.K.		Frankreich	Italien	Spanien	Schweden	Japan	USA	China
W-nr.	DIN	BS	EN	AFNOR	UNI	UNE	SS	JIS	AISI/SAE	GB
0.7040	GGG 40	SNG 420/12	–	FCS 400-12	GS 370-17	FGE 38-17	07 17-02	FCD400	60-40-18	QT400-18
–	GGG 40.3	SNG 370/17	–	FGS 370-17	–	–	07 17-12	–	–	–
0.7033	GGG 35.3	–	–	–	–	–	07 17-15	–	–	–
0.7050	GGG 50	SNG 500/7	–	FGS 500-7	GS 500	FGE 50-7	07 27-02	FCD500	80-55-06	QT500-7
0.7660	GGG NiCr202	Grade S6	–	S-NC202	–	–	07 76	–	A43D2	–
–	GGG NiMn137	L-NiMn 137	–	L-MN 137	–	–	07 72	–	–	–
–	GGG 60	SNG 600/3	–	FGS 600-3	–	–	07 32-03	FCD600	–	QT600-3
0.7070	GGG 70	SNG 700/2	–	FGS 700-2	GS 700-2	FGS 70-2	07 37-01	FCD700	100-70-03	QT700-18

### ■ TEMPERGUSS

Deutschland		U.K.		Frankreich	Italien	Spanien	Schweden	Japan	USA	China
W-nr.	DIN	BS	EN	AFNOR	UNI	UNE	SS	JIS	AISI/SAE	GB
–	–	8 290/6	–	MN 32-8	–	–	08 14	FCMB310	–	–
–	GTS-35	B 340/12	–	MN 35-10	–	–	08 15	FCMW330	32510	–
0.8145	GTS-45	P 440/7	–	Mn 450	GMN45	–	08 52	FCMW370	40010	–
0.8155	GTS-55	P 510/4	–	MP 50-5	GMN55	–	08 54	FCMP490	50005	–
–	GTS-65	P 570/3	–	MP 60-3	–	–	08 58	FCMP540	70003	–
0.8165	GTS-65-02	P 570/3	–	Mn 650-3	GMN 65	–	08 56	FCMP590	A220-70003	–
–	GTS-70-02	P 690/2	–	Mn 700-2	GMN 70	–	08 62	FCMP690	A220-80002	–

# OBERFLÄCHENRAUHIGKEIT

## OBERFLÄCHENRAUHIGKEIT

(von JIS B 0601-1994)

TECHNISCHE DATEN

Typ	Symbol	Berechnungsmethode	Messaufnahme (Abbildung)
Mittlere Rauhtiefe	Ra	<p>Der Mittelrauhwert Ra ist der arithmetische Mittelwert der absoluten Beträge der Abstände y des Rauheitsprofils von der Mittellinie innerhalb der Messtrecke. Dies ist gleichbedeutend mit der Höhe des Rechtecks, dessen Länge gleich der Gesamtstrecke l ist und das flächengleich mit der Summe der zwischen dem Rauheitsprofil und der Mittellinie eingeschlossenen Fläche ist <math>y=f</math>.</p> $Ra = \frac{1}{l} \int_0^l  f(x)  dx$	
Maximale Rauhtiefe	Rz	<p>Die maximale Rauhtiefe Ry ist die größte der auf der Gesamtmeßstrecke l vorkommenden Einzelrauhtiefen. Rz wird auch in (<math>\mu\text{m}</math>) Mikrometer angegeben. Hinweis: Um Rz herauszufinden, wird ein Anteil ohne außergewöhnliche Höhen und Tiefen als Stichprobenlänge ausgewählt und als Schwachstelle betrachtet.</p> $Rz = Rp + Rv$	
Gemittelte Rauhtiefe	RzJIS	<p>Die gemittelte Rauhtiefe Rz ist das arithmetische Mittel aus den Einzelrauhtiefen fünf aufeinander grenzender Einzelmessstrecken gleicher Länge. Rz wird ebenfalls in (<math>\mu\text{m}</math>) angegeben.</p> $Rz_{JIS} = \frac{(Yp1+Yp2+Yp3+Yp4+Yp5) + (Yv1+Yv2+Yv3+Yv4+Yv5)}{5}$	<p><i>Yp1, Yp2, Yp3, Yp4, Yp5</i> : Die 5 tiefsten Messpunkte einer ausgewählten Strecke entsprechend der Länge l. <i>Yv1, Yv2, Yv3, Yv4, Yv5</i> : Die 5 tiefsten Messpunkte einer ausgewählten Strecke entsprechend der Länge l.</p>

### ZUORDNUNG DER GEMITTELTEN WERTE (Ra) ZU DEN OBERFLÄCHENANGABEN

Mittlere Rauhtiefe Ra		Maximale Rauhtiefe Rz	Gemittelte Rauhtiefe RzJIS	Prüflänge für Rz • RzJIS l (mm)	Oberflächenzeichen
Standard	Richtwerte λc (mm)	Standard			
0.012 a	0.08	0.05s	0.05z	0.08	▽▽▽▽
0.025 a		0.1 s	0.1 z		
0.05 a	0.25	0.2 s	0.2 z	0.25	
0.1 a		0.4 s	0.4 z		
0.2 a		0.8 s	0.8 z		
0.4 a	0.8	1.6 s	1.6 z	0.8	▽▽▽
0.8 a		3.2 s	3.2 z		
1.6 a		6.3 s	6.3 z		
3.2 a		12.5 s	12.5 z		
6.3 a	2.5	25 s	25 z	2.5	▽▽
12.5 a		50 s	50 z		
25 a	8	100 s	100 z	8	▽
50 a		200 s	200 z		
100 a	—	400 s	400 z	—	—

\*Die Zuordnung dieser 3 Darstellungen ist zweckdienlich und nicht exakt.

\*Ra: Die Bewertungslänge von Rz und RzJIS ist der Abschaltwert und die Stichprobenlänge multipliziert x 5.

# HÄRTEVERGLEICHSTABELLE

## VERGLEICHSTABELLEN HÄRTE VON STAHL

Brinell Härte (HB) 10mm Kugel, Last: 3000kgf		Vickers Härte	Rockwell Härte				Shore Härte	Streckgrenze (ca.) MPa	Brinell Härte (HB) 10mm Kugel, Last: 3000kgf		Vickers Härte	Rockwell Härte				Shore Härte	Streckgrenze (ca.) MPa
Standard Kugel	Hartmetallkugel		A Skala, Last: 60kgf Diamantkegel	B Skala, Last: 100kgf 1/16" Kugel	C Skala, Last: 150kgf Diamantkegel	D Skala, Last: 100kgf Diamantkegel			Standard Kugel	Hartmetallkugel		A Skala, Last: 60kgf Diamantkegel	B Skala, Last: 100kgf 1/16" Kugel	C Skala, Last: 150kgf Diamantkegel	D Skala, Last: 100kgf Diamantkegel		
		(HV)	(HRA)	(HRB)	(HRC)	(HRD)	(HS)			(HV)	(HRA)	(HRB)	(HRC)	(HRD)	(HS)		
—	—	940	85.6	—	68.0	76.9	97	—	429	429	455	73.4	—	45.7	59.7	61	1510
—	—	920	85.3	—	67.5	76.5	96	—	415	415	440	72.8	—	44.5	58.8	59	1460
—	—	900	85.0	—	67.0	76.1	95	—	401	401	425	72.0	—	43.1	57.8	58	1390
—	(767)	880	84.7	—	66.4	75.7	93	—	388	388	410	71.4	—	41.8	56.8	56	1330
—	(757)	860	84.4	—	65.9	75.3	92	—	375	375	396	70.6	—	40.4	55.7	54	1270
—	(745)	840	84.1	—	65.3	74.8	91	—	363	363	383	70.0	—	39.1	54.6	52	1220
—	(733)	820	83.8	—	64.7	74.3	90	—	352	352	372	69.3	(110.0)	37.9	53.8	51	1180
—	(722)	800	83.4	—	64.0	73.8	88	—	341	341	360	68.7	(109.0)	36.6	52.8	50	1130
—	(712)	—	—	—	—	—	—	—	331	331	350	68.1	(108.5)	35.5	51.9	48	1095
—	(710)	780	83.0	—	63.3	73.3	87	—	321	321	339	67.5	(108.0)	34.3	51.0	47	1060
—	(698)	760	82.6	—	62.5	72.6	86	—	—	—	—	—	—	—	—	—	—
—	(684)	740	82.2	—	61.8	72.1	—	—	311	311	328	66.9	(107.5)	33.1	50.0	46	1025
—	(682)	737	82.2	—	61.7	72.0	84	—	302	302	319	66.3	(107.0)	32.1	49.3	45	1005
—	(670)	720	81.8	—	61.0	71.5	83	—	293	293	309	65.7	(106.0)	30.9	48.3	43	970
—	(656)	700	81.3	—	60.1	70.8	—	—	285	285	301	65.3	(105.5)	29.9	47.6	—	950
—	(653)	697	81.2	—	60.0	70.7	81	—	277	277	292	64.6	(104.5)	28.8	46.7	41	925
—	(647)	690	81.1	—	59.7	70.5	—	—	269	269	284	64.1	(104.0)	27.6	45.9	40	895
—	(638)	680	80.8	—	59.2	70.1	80	—	262	262	276	63.6	(103.0)	26.6	45.0	39	875
—	630	670	80.6	—	58.8	69.8	—	—	255	255	269	63.0	(102.0)	25.4	44.2	38	850
—	627	667	80.5	—	58.7	69.7	79	—	248	248	261	62.5	(101.0)	24.2	43.2	37	825
—	—	677	80.7	—	59.1	70.0	—	—	241	241	253	61.8	100	22.8	42.0	36	800
—	601	640	79.8	—	57.3	68.7	77	—	235	235	247	61.4	99.0	21.7	41.4	35	785
—	—	640	79.8	—	57.3	68.7	—	—	229	229	241	60.8	98.2	20.5	40.5	34	765
—	578	615	79.1	—	56.0	67.7	75	—	223	223	234	—	97.3	(18.8)	—	—	—
—	—	607	78.8	—	55.6	67.4	—	—	217	217	228	—	96.4	(17.5)	—	33	725
—	555	591	78.4	—	54.7	66.7	73	2055	212	212	222	—	95.5	(16.0)	—	—	705
—	—	607	78.8	—	55.6	67.4	—	—	207	207	218	—	94.6	(15.2)	—	32	690
—	—	579	78.0	—	54.0	66.1	—	2015	201	201	212	—	93.8	(13.8)	—	31	675
—	534	569	77.8	—	53.5	65.8	71	1985	197	197	207	—	92.8	(12.7)	—	30	655
—	—	533	77.1	—	52.5	65.0	—	1915	192	192	202	—	91.9	(11.5)	—	29	640
—	514	547	76.9	—	52.1	64.7	70	1890	187	187	196	—	90.7	(10.0)	—	—	620
(495)	—	539	76.7	—	51.6	64.3	—	1855	183	183	192	—	90.0	(9.0)	—	28	615
—	—	530	76.4	—	51.1	63.9	—	1825	179	179	188	—	89.0	(8.0)	—	27	600
—	495	528	76.3	—	51.0	63.8	68	1820	174	174	182	—	87.8	(6.4)	—	—	585
(477)	—	516	75.9	—	50.3	63.2	—	1780	170	170	178	—	86.8	(5.4)	—	26	570
—	—	508	75.6	—	49.6	62.7	—	1740	167	167	175	—	86.0	(4.4)	—	—	560
—	477	508	75.6	—	49.6	62.7	66	1740	143	143	150	—	85.0	(3.3)	—	25	545
(461)	—	495	75.1	—	48.8	61.9	—	1680	143	143	150	—	82.9	(0.9)	—	—	525
—	—	491	74.9	—	48.5	61.7	—	1670	149	149	156	—	80.8	—	—	23	505
—	461	491	74.9	—	48.5	61.7	65	1670	143	143	150	—	78.7	—	—	22	490
—	—	474	74.3	—	47.2	61.0	—	1595	137	137	143	—	76.4	—	—	21	460
—	—	472	74.2	—	47.1	60.8	—	1585	126	126	132	—	74.0	—	—	—	450
—	444	472	74.2	—	47.1	60.8	63	1585	121	121	127	—	72.0	—	—	20	435
—	—	472	74.2	—	47.1	60.8	—	1585	121	121	127	—	72.0	—	—	19	415
—	—	472	74.2	—	47.1	60.8	—	1585	116	116	122	—	69.8	—	—	18	400
—	—	472	74.2	—	47.1	60.8	—	1585	116	116	122	—	67.6	—	—	18	400
—	—	472	74.2	—	47.1	60.8	—	1585	111	111	117	—	65.7	—	—	15	385

Hinweis 1) Die obige Tabelle ist vergleichbar mit den Angaben aus dem AMS Metallhandbuch mit genäherten Werten für Streckgrenze und Brinellhärte über einer empfohlenen Strecke.

Hinweis 2) 1MPa=1N/mm<sup>2</sup>

Hinweis 3) Werte in Klammern werden selten benutzt und stehen nur als Ergänzung in der Tabelle. Diese Tabelle ist aus dem JIS Handbuch für Stahl entnommen.

# TOLERANZANGABEN FÜR INNENDURCHMESSER (BOHRUNG)

TECHNISCHE DATEN

Klassifizierung der Standard Abmessungen (mm)		Baureihe des geometrischen Toleranzbereichs der Löcher															
>	≤	B10	C9	C10	D8	D9	D10	E7	E8	E9	F6	F7	F8	G6	G7	H6	H7
—	3	+180	+85	+100	+34	+45	+60	+24	+28	+39	+12	+16	+20	+8	+12	+6	+10
		+140	+60	+60	+20	+20	+20	+14	+14	+14	+6	+6	+6	+2	+2	0	0
3	6	+188	+100	+118	+48	+60	+78	+32	+38	+50	+18	+22	+28	+12	+16	+8	+12
		+140	+70	+70	+30	+30	+30	+20	+20	+20	+10	+10	+10	+4	+4	0	0
6	10	+208	+116	+138	+62	+76	+98	+40	+47	+61	+22	+28	+35	+14	+20	+9	+15
		+150	+80	+80	+40	+40	+40	+25	+25	+25	+13	+13	+13	+5	+5	0	0
10	14	+220	+138	+165	+77	+93	+120	+50	+59	+75	+27	+34	+43	+17	+24	+11	+18
		+150	+95	+95	+50	+50	+50	+32	+32	+32	+16	+16	+16	+6	+6	0	0
14	18	+244	+162	+194	+98	+117	+149	+61	+73	+92	+33	+41	+53	+20	+28	+13	+21
		+160	+110	+110	+65	+65	+65	+40	+40	+40	+20	+20	+20	+7	+7	0	0
18	24	+270	+182	+220	+119	+142	+180	+75	+89	+112	+41	+50	+64	+25	+34	+16	+25
		+170	+120	+120	+80	+80	+80	+50	+50	+50	+25	+25	+25	+9	+9	0	0
30	40	+280	+192	+230	+146	+174	+220	+90	+106	+134	+49	+60	+76	+29	+40	+19	+30
		+180	+130	+130	+100	+100	+100	+60	+60	+60	+30	+30	+30	+10	+10	0	0
40	50	+310	+214	+260	+208	+245	+305	+125	+148	+185	+68	+83	+106	+39	+54	+25	+40
		+190	+140	+140	+145	+145	+145	+85	+85	+85	+43	+43	+43	+14	+14	0	0
50	65	+320	+224	+270	+271	+320	+400	+162	+191	+240	+88	+108	+137	+49	+69	+32	+52
		+200	+150	+150	+190	+190	+190	+110	+110	+110	+56	+56	+56	+17	+17	0	0
80	100	+360	+257	+310	+299	+350	+440	+182	+214	+265	+98	+119	+151	+54	+75	+36	+57
		+220	+170	+170	+170	+170	+170	+100	+100	+100	+50	+50	+50	+15	+15	0	0
100	120	+380	+267	+320	+210	+210	+210	+125	+125	+125	+62	+62	+62	+18	+18	0	0
		+240	+180	+180	+208	+245	+305	+125	+148	+185	+68	+83	+106	+39	+54	+25	+40
120	140	+420	+300	+360	+208	+245	+305	+125	+148	+185	+68	+83	+106	+39	+54	+25	+40
		+260	+200	+200	+145	+145	+145	+85	+85	+85	+43	+43	+43	+14	+14	0	0
140	160	+440	+310	+370	+208	+245	+305	+125	+148	+185	+68	+83	+106	+39	+54	+25	+40
		+280	+210	+210	+145	+145	+145	+85	+85	+85	+43	+43	+43	+14	+14	0	0
160	180	+470	+330	+390	+208	+245	+305	+125	+148	+185	+68	+83	+106	+39	+54	+25	+40
		+310	+230	+230	+145	+145	+145	+85	+85	+85	+43	+43	+43	+14	+14	0	0
180	200	+525	+355	+425	+242	+285	+355	+146	+172	+215	+79	+96	+122	+44	+61	+29	+46
		+340	+240	+240	+170	+170	+170	+100	+100	+100	+50	+50	+50	+15	+15	0	0
200	225	+565	+375	+445	+242	+285	+355	+146	+172	+215	+79	+96	+122	+44	+61	+29	+46
		+380	+260	+260	+170	+170	+170	+100	+100	+100	+50	+50	+50	+15	+15	0	0
225	250	+605	+395	+465	+242	+285	+355	+146	+172	+215	+79	+96	+122	+44	+61	+29	+46
		+420	+280	+280	+170	+170	+170	+100	+100	+100	+50	+50	+50	+15	+15	0	0
250	280	+690	+430	+510	+271	+320	+400	+162	+191	+240	+88	+108	+137	+49	+69	+32	+52
		+480	+300	+300	+190	+190	+190	+110	+110	+110	+56	+56	+56	+17	+17	0	0
280	315	+750	+460	+540	+271	+320	+400	+162	+191	+240	+88	+108	+137	+49	+69	+32	+52
		+540	+330	+330	+190	+190	+190	+110	+110	+110	+56	+56	+56	+17	+17	0	0
315	355	+830	+500	+590	+299	+350	+440	+182	+214	+265	+98	+119	+151	+54	+75	+36	+57
		+600	+360	+360	+210	+210	+210	+125	+125	+125	+62	+62	+62	+18	+18	0	0
355	400	+910	+540	+630	+210	+210	+210	+125	+125	+125	+62	+62	+62	+18	+18	0	0
		+680	+400	+400	+210	+210	+210	+125	+125	+125	+62	+62	+62	+18	+18	0	0
400	450	+1010	+595	+690	+327	+385	+480	+198	+232	+290	+108	+131	+165	+60	+83	+40	+63
		+760	+440	+440	+327	+385	+480	+198	+232	+290	+108	+131	+165	+60	+83	+40	+63
450	500	+1090	+635	+730	+230	+230	+230	+135	+135	+135	+68	+68	+68	+20	+20	0	0
		+840	+480	+480	+230	+230	+230	+135	+135	+135	+68	+68	+68	+20	+20	0	0

Hinweis 1) Aufgezeigte Werte im oberen Teil der jeweiligen Linien weisen überdimensionale Toleranzen auf, während die Werte in dem unteren Teil niedrige Toleranzangaben aufweisen.

Baureihe des geometrischen Toleranzbereichs der Löcher

H8	H9	H10	JS6	JS7	K6	K7	M6	M7	N6	N7	P6	P7	R7	S7	T7	U7	X7
+14 0	+25 0	+40 0	$\pm 3$	$\pm 5$	0 -6	0 -10	-2 -8	-2 -12	-4 -10	-4 -14	-6 -12	-6 -16	-10 -20	-14 -24	-	-18 -28	-20 -30
+18 0	+30 0	+48 0	$\pm 4$	$\pm 6$	+2 -6	+3 -9	-1 -9	0 -12	-5 -13	-4 -16	-9 -17	-8 -20	-11 -23	-15 -27	-	-19 -31	-24 -36
+22 0	+36 0	+58 0	$\pm 4.5$	$\pm 7$	+2 -7	+5 -10	-3 -12	0 -15	-7 -16	-4 -19	-12 -21	-9 -24	-13 -28	-17 -32	-	-22 -37	-28 -43
+27 0	+43 0	+70 0	$\pm 5.5$	$\pm 9$	+2 -9	+6 -12	-4 -15	0 -18	-9 -20	-5 -23	-15 -26	-11 -29	-16 -34	-21 -39	-	-26 -44	-33 -51 -56
+33 0	+52 0	+84 0	$\pm 6.5$	$\pm 10$	+2 -11	+6 -15	-4 -17	0 -21	-11 -24	-7 -28	-18 -31	-14 -35	-20 -41	-27 -48	-	-33 -54	-46 -67 -77
+39 0	+62 0	+100 0	$\pm 8$	$\pm 12$	+3 -13	+7 -18	-4 -20	0 -25	-12 -28	-8 -33	-21 -37	-17 -42	-25 -50	-34 -59	-	-39 -64 -70	-51 -76 -86
+46 0	+74 0	+120 0	$\pm 9.5$	$\pm 15$	+4 -15	+9 -21	-5 -24	0 -30	-14 -33	-9 -39	-26 -45	-21 -51	-30 -60 -62	-42 -72 -78	-55 -85 -94	-76 -106 -121	-
+54 0	+87 0	+140 0	$\pm 11$	$\pm 17$	+4 -18	+10 -25	-6 -28	0 -35	-16 -38	-10 -45	-30 -52	-24 -59	-38 -73 -81	-58 -93 -101	-78 -113 -126	-111 -146 -166	-
+63 0	+100 0	+160 0	$\pm 12.5$	$\pm 20$	+4 -21	+12 -28	-8 -33	0 -40	-20 -45	-12 -52	-36 -61	-28 -68	-48 -88 -90 -93	-77 -117 -125 -133	-107 -147 -159 -171	-	-
+72 0	+115 0	+185 0	$\pm 14.5$	$\pm 23$	+5 -24	+13 -33	-8 -37	0 -46	-22 -51	-14 -60	-41 -70	-33 -79	-60 -105 -106	-113 -159 -169	-	-	-
+81 0	+130 0	+210 0	$\pm 16$	$\pm 26$	+5 -27	+16 -36	-9 -41	0 -52	-25 -57	-14 -66	-47 -79	-36 -88	-74 -126 -78 -130	-	-	-	-
+89 0	+140 0	+230 0	$\pm 18$	$\pm 28$	+7 -29	+17 -40	-10 -46	0 -57	-26 -62	-16 -73	-51 -87	-41 -98	-87 -144 -93 -150	-	-	-	-
+97 0	+155 0	+250 0	$\pm 20$	$\pm 31$	+8 -32	+18 -45	-10 -50	0 -63	-27 -67	-17 -80	-55 -95	-45 -108	-103 -166 -109 -172	-	-	-	-

# ISO-PASSUNGEN EINHEITSWELLE

TECHNISCHE DATEN

Klassifizierung der Standard Abmessungen (mm)		Baureihe des geometrischen Toleranzbereichs der Schäfte														
>	≤	b9	c9	d8	d9	e7	e8	e9	f6	f7	f8	g5	g6	h5	h6	h7
-	3	-140	-60	-20	-20	-14	-14	-14	-6	-6	-6	-2	-2	0	0	0
		-165	-85	-34	-45	-24	-28	-39	-12	-16	-20	-6	-8	-4	-6	-10
3	6	-140	-70	-30	-30	-20	-20	-20	-10	-10	-10	-4	-4	0	0	0
		-170	-100	-48	-60	-32	-38	-50	-18	-22	-28	-9	-12	-5	-8	-12
6	10	-150	-80	-40	-40	-25	-25	-25	-13	-13	-13	-5	-5	0	0	0
		-186	-116	-62	-76	-40	-47	-61	-22	-28	-35	-11	-14	-6	-9	-15
10	14	-150	-95	-50	-50	-32	-32	-32	-16	-16	-16	-6	-6	0	0	0
		-193	-138	-77	-93	-50	-59	-75	-27	-34	-43	-14	-17	-8	-11	-18
14	18	-150	-95	-50	-50	-32	-32	-32	-16	-16	-16	-6	-6	0	0	0
		-193	-138	-77	-93	-50	-59	-75	-27	-34	-43	-14	-17	-8	-11	-18
18	24	-160	-110	-65	-65	-40	-40	-40	-20	-20	-20	-7	-7	0	0	0
		-212	-162	-98	-117	-61	-73	-92	-33	-41	-53	-16	-20	-9	-13	-21
24	30	-160	-110	-65	-65	-40	-40	-40	-20	-20	-20	-7	-7	0	0	0
		-212	-162	-98	-117	-61	-73	-92	-33	-41	-53	-16	-20	-9	-13	-21
30	40	-170	-120	-80	-80	-50	-50	-50	-25	-25	-25	-9	-9	0	0	0
		-232	-182	-119	-142	-75	-89	-112	-41	-50	-64	-20	-25	-11	-16	-25
40	50	-180	-130	-119	-142	-75	-89	-112	-41	-50	-64	-20	-25	-11	-16	-25
		-242	-192	-146	-174	-90	-106	-134	-49	-60	-76	-23	-29	-13	-19	-30
50	65	-190	-140	-100	-100	-60	-60	-60	-30	-30	-30	-10	-10	0	0	0
		-264	-214	-146	-174	-90	-106	-134	-49	-60	-76	-23	-29	-13	-19	-30
65	80	-200	-150	-146	-174	-90	-106	-134	-49	-60	-76	-23	-29	-13	-19	-30
		-274	-224	-170	-207	-107	-126	-159	-58	-71	-90	-27	-34	-15	-22	-35
80	100	-220	-170	-120	-120	-72	-72	-72	-36	-36	-36	-12	-12	0	0	0
		-307	-257	-174	-207	-107	-126	-159	-58	-71	-90	-27	-34	-15	-22	-35
100	120	-240	-180	-174	-207	-107	-126	-159	-58	-71	-90	-27	-34	-15	-22	-35
		-327	-267	-145	-145	-85	-85	-85	-43	-43	-43	-14	-14	0	0	0
120	140	-260	-200	-145	-145	-85	-85	-85	-43	-43	-43	-14	-14	0	0	0
		-360	-300	-208	-245	-125	-148	-185	-68	-83	-106	-32	-39	-18	-25	-40
140	160	-280	-210	-145	-145	-85	-85	-85	-43	-43	-43	-14	-14	0	0	0
		-380	-310	-208	-245	-125	-148	-185	-68	-83	-106	-32	-39	-18	-25	-40
160	180	-310	-230	-208	-245	-125	-148	-185	-68	-83	-106	-32	-39	-18	-25	-40
		-410	-330	-170	-170	-100	-100	-100	-50	-50	-50	-15	-15	0	0	0
180	200	-340	-240	-170	-170	-100	-100	-100	-50	-50	-50	-15	-15	0	0	0
		-455	-355	-242	-285	-146	-172	-215	-79	-96	-122	-35	-44	-20	-29	-46
200	225	-380	-260	-242	-285	-146	-172	-215	-79	-96	-122	-35	-44	-20	-29	-46
		-495	-375	-190	-190	-110	-110	-110	-56	-56	-56	-17	-17	0	0	0
225	250	-420	-280	-190	-190	-110	-110	-110	-56	-56	-56	-17	-17	0	0	0
		-535	-395	-271	-320	-162	-191	-240	-88	-108	-137	-40	-49	-23	-32	-52
250	280	-480	-300	-271	-320	-162	-191	-240	-88	-108	-137	-40	-49	-23	-32	-52
		-610	-430	-210	-210	-125	-125	-125	-62	-62	-62	-18	-18	0	0	0
280	315	-540	-330	-210	-210	-125	-125	-125	-62	-62	-62	-18	-18	0	0	0
		-670	-460	-299	-350	-182	-214	-265	-98	-119	-151	-43	-54	-25	-36	-57
315	355	-600	-360	-299	-350	-182	-214	-265	-98	-119	-151	-43	-54	-25	-36	-57
		-740	-500	-230	-230	-135	-135	-135	-68	-68	-68	-20	-20	0	0	0
355	400	-680	-400	-230	-230	-135	-135	-135	-68	-68	-68	-20	-20	0	0	0
		-820	-540	-327	-385	-198	-232	-290	-108	-131	-165	-47	-60	-27	-40	-63
400	450	-760	-440	-327	-385	-198	-232	-290	-108	-131	-165	-47	-60	-27	-40	-63
		-915	-595	-840	-480	-327	-385	-198	-232	-290	-108	-131	-165	-47	-60	-63
450	500	-840	-480	-327	-385	-198	-232	-290	-108	-131	-165	-47	-60	-27	-40	-63
		-995	-635													

Hinweis 1) Aufgezeigte Werte im oberen Teil der jeweiligen Linien weisen überdimensionale Toleranzen auf, während die Werte in dem unteren Teil niedrige Toleranzangaben aufweisen.

Baureihe des geometrischen Toleranzbereichs der Schäfte

h8	h9	js5	js6	js7	k5	k6	m5	m6	n6	p6	r6	s6	t6	u6	x6
0 -14	0 -25	$\pm 2$	$\pm 3$	$\pm 5$	+4 0	+6 0	+6 +2	+8 +2	+10 +4	+12 +6	+16 +10	+20 +14	—	+24 +18	+26 +20
0 -18	0 -30	$\pm 2.5$	$\pm 4$	$\pm 6$	+6 +1	+9 +1	+9 +4	+12 +4	+16 +8	+20 +12	+23 +15	+27 +19	—	+31 +23	+36 +28
0 -22	0 -36	$\pm 3$	$\pm 4.5$	$\pm 7$	+7 +1	+10 +1	+12 +6	+15 +6	+19 +10	+24 +15	+28 +19	+32 +23	—	+37 +28	+43 +34
0 -27	0 -43	$\pm 4$	$\pm 5.5$	$\pm 9$	+9 +1	+12 +1	+15 +7	+18 +7	+23 +12	+29 +18	+34 +23	+39 +28	—	+44 +33	+51 +40 +56 +45
0 -33	0 -52	$\pm 4.5$	$\pm 6.5$	$\pm 10$	+11 +2	+15 +2	+17 +8	+21 +8	+28 +15	+35 +22	+41 +28	+48 +35	— +54 +41	+54 +61 +48	+67 +54 +77 +64
0 -39	0 -62	$\pm 5.5$	$\pm 8$	$\pm 12$	+13 +2	+18 +2	+20 +9	+25 +9	+33 +17	+42 +26	+50 +34	+59 +43	+64 +48 +70 +54	+76 +60 +86 +70	—
0 -46	0 -74	$\pm 6.5$	$\pm 9.5$	$\pm 15$	+15 +2	+21 +2	+24 +11	+30 +11	+39 +20	+51 +32	+60 +41 +62 +43	+72 +53 +78 +59	+85 +66 +94 +75	+106 +87 +121 +102	—
0 -54	0 -87	$\pm 7.5$	$\pm 11$	$\pm 17$	+18 +3	+25 +3	+28 +13	+35 +13	+45 +23	+59 +37	+73 +51 +76 +54	+93 +71 +101 +79	+113 +91 +126 +104	+146 +124 +166 +144	—
0 -63	0 -100	$\pm 9$	$\pm 12.5$	$\pm 20$	+21 +3	+28 +3	+33 +15	+40 +15	+52 +27	+68 +43	+88 +63 +90 +65 +93 +68	+117 +92 +125 +100 +133 +108	+147 +122 +159 +134 +171 +146	—	—
0 -72	0 -115	$\pm 10$	$\pm 14.5$	$\pm 23$	+24 +4	+33 +4	+37 +17	+46 +17	+60 +31	+79 +50	+106 +77 +109 +80 +113 +84	+151 +122 +159 +130 +169 +140	—	—	—
0 -81	0 -130	$\pm 11.5$	$\pm 16$	$\pm 26$	+27 +4	+36 +4	+43 +20	+52 +20	+66 +34	+88 +56	+126 +94 +130 +98	—	—	—	—
0 -89	0 -140	$\pm 12.5$	$\pm 18$	$\pm 28$	+29 +4	+40 +4	+46 +21	+57 +21	+73 +37	+98 +62	+144 +108 +150 +114	—	—	—	—
0 -97	0 -155	$\pm 13.5$	$\pm 20$	$\pm 31$	+32 +5	+45 +5	+50 +23	+63 +23	+80 +40	+108 +68	+166 +126 +172 +132	—	—	—	—

# BOHRDURCHMESSER FÜR GEWINDEKERNBORHUNGEN

● **Metrische Gewindekernlöcher**

Nominal	Bohrerdurchmesser	
	HSS	Hartmetall
M1 ×0.25	0.75	0.75
M1.1×0.25	0.85	0.85
M1.2×0.25	0.95	0.95
M1.4×0.3	1.10	1.10
M1.6×0.35	1.25	1.30
M1.7×0.35	1.35	1.40
M1.8×0.35	1.45	1.50
M2 ×0.4	1.60	1.65
M2.2×0.45	1.75	1.80
M2.3×0.4	1.90	1.95
M2.5×0.45	2.10	2.15
M2.6×0.45	2.15	2.20
M3 ×0.5	2.50	2.55
M3.5×0.6	2.90	2.95
M4 ×0.7	3.3	3.4
M4.5×0.75	3.8	3.9
M5 ×0.8	4.2	4.3
M6 ×1.0	5.0	5.1
M7 ×1.0	6.0	6.1
M8 ×1.25	6.8	6.9
M9 ×1.25	7.8	7.9
M10 ×1.5	8.5	8.7
M11 ×1.5	9.5	9.7
M12 ×1.75	10.3	10.5
M14 ×2.0	12.0	12.2
M16 ×2.0	14.0	14.2
M18 ×2.5	15.5	15.7
M20 ×2.5	17.5	17.7
M22 ×2.5	19.5	19.7
M24 ×3.0	21.0	—
M27 ×3.0	24.0	—
M30 ×3.5	26.5	—
M33 ×3.5	29.5	—
M36 ×4.0	32.0	—
M39 ×4.0	35.0	—
M42 ×4.5	37.5	—
M45 ×4.5	40.5	—
M48 ×5.0	43.0	—

● **Metrisches Feingewinde**

Nominal	Bohrerdurchmesser		Nominal	Bohrerdurchmesser		Nominal	Bohrerdurchmesser	
	HSS	Hartmetall		HSS	Hartmetall		HSS	Hartmetall
M1 ×0.2	0.80	0.80	M20 ×2.0	18.0	18.3	M42 ×3.0	39.0	—
M1.1×0.2	0.90	0.90	M20 ×1.5	18.5	18.7	M42 ×2.0	40.0	—
M1.2×0.2	1.00	1.00	M20 ×1.0	19.0	19.1	M42 ×1.5	40.5	—
M1.4×0.2	1.20	1.20	M22 ×2.0	20.0	—	M45 ×4.0	41.0	—
M1.6×0.2	1.40	1.40	M22 ×1.5	20.5	—	M45 ×3.0	42.0	—
M1.8×0.2	1.60	1.60	M22 ×1.0	21.0	—	M45 ×2.0	43.0	—
M2 ×0.25	1.75	1.75	M24 ×2.0	22.0	—	M45 ×1.5	43.5	—
M2.2×0.25	1.95	2.00	M24 ×1.5	22.5	—	M48 ×4.0	44.0	—
M2.5×0.35	2.20	2.20	M24 ×1.0	23.0	—	M48 ×3.0	45.0	—
M3 ×0.35	2.70	2.70	M25 ×2.0	23.0	—	M48 ×2.0	46.0	—
M3.5×0.35	3.20	3.20	M25 ×1.5	23.5	—	M48 ×1.5	46.5	—
M4 ×0.5	3.50	3.55	M25 ×1.0	24.0	—	M50 ×3.0	47.0	—
M4.5×0.5	4.00	4.05	M26 ×1.5	24.5	—	M50 ×2.0	48.0	—
M5 ×0.5	4.50	4.55	M27 ×2.0	25.0	—	M50 ×1.5	48.5	—
M5.5×0.5	5.00	5.05	M27 ×1.5	25.5	—			
M6 ×0.75	5.30	5.35	M27 ×1.0	26.0	—			
M7 ×0.75	6.30	6.35	M28 ×2.0	26.0	—			
M8 ×1.0	7.00	7.10	M28 ×1.5	26.5	—			
M8 ×0.75	7.30	7.35	M28 ×1.0	27.0	—			
M9 ×1.0	8.00	8.10	M30 ×3.0	27.0	—			
M9 ×0.75	8.30	8.35	M30 ×2.0	28.0	—			
M10 ×1.25	8.80	8.90	M30 ×1.5	28.5	—			
M10 ×1.0	9.00	9.10	M30 ×1.0	29.0	—			
M10 ×0.75	9.30	9.35	M32 ×2.0	30.0	—			
M11 ×1.0	10.0	10.1	M32 ×1.5	30.5	—			
M11 ×0.75	10.3	10.3	M33 ×3.0	30.0	—			
M12 ×1.5	10.5	10.7	M33 ×2.0	31.0	—			
M12 ×1.25	10.8	10.9	M33 ×1.5	31.5	—			
M12 ×1.0	11.0	11.1	M35 ×1.5	33.5	—			
M14 ×1.5	12.5	12.7	M36 ×3.0	33.0	—			
M14 ×1.0	13.0	13.1	M36 ×2.0	34.0	—			
M15 ×1.5	13.5	13.7	M36 ×1.5	34.5	—			
M15 ×1.0	14.0	14.1	M38 ×1.5	36.5	—			
M16 ×1.5	14.5	14.7	M39 ×3.0	36.0	—			
M16 ×1.0	15.0	15.1	M39 ×2.0	37.0	—			
M17 ×1.5	15.5	15.7	M39 ×1.5	37.5	—			
M17 ×1.0	16.0	16.1	M40 ×3.0	37.0	—			
M18 ×2.0	16.0	16.3	M40 ×2.0	38.0	—			
M18 ×1.5	16.5	16.7	M40 ×1.5	38.5	—			
M18 ×1.0	17.0	17.1	M42 ×4.0	38.0	—			

TECHNISCHE DATEN

P



# HEXAGON ZYLINDERSCHRAUBE

## HEXAGONALE LOCHABMESSUNGEN FÜR KLEMMSCHRAUBEN usw. Maß: : mm

Nominale Gewindeabmessung d	M3	M4	M5	M6	M8	M10	M12	M14	M16	M18	M20	M22	M24	M27	M30
<b>d<sub>1</sub></b>	3	4	5	6	8	10	12	14	16	18	20	22	24	27	30
<b>d'</b>	3.4	4.5	5.5	6.6	9	11	14	16	18	20	22	24	26	30	33
<b>D</b>	5.5	7	8.5	10	13	16	18	21	24	27	30	33	36	40	45
<b>D'</b>	6.5	8	9.5	11	14	17.5	20	23	26	29	32	35	39	43	48
<b>H</b>	3	4	5	6	8	10	12	14	16	18	20	22	24	27	30
<b>H'</b>	2.7	3.6	4.6	5.5	7.4	9.2	11	12.8	14.5	16.5	18.5	20.5	22.5	25	28
<b>H''</b>	3.3	4.4	5.4	6.5	8.6	10.8	13	15.2	17.5	19.5	21.5	23.5	25.5	29	32

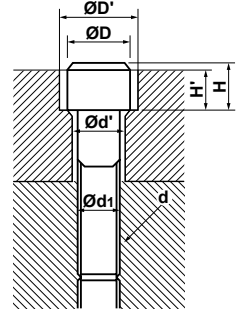
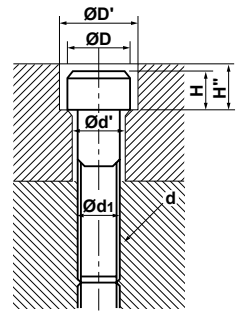

P

TECHNISCHE DATEN

# INTERNATIONAL EINHEITLICHES SYSTEM

**■ EINHEITLICHE UMRECHNUNGSTABELLE ZUR VEREINFACHUNG DER WANDLUNG IN SI-EINHEITEN (Fettschrift zeigt die SI-Einheiten)**

**● Druck**

Pa	kPa	MPa	bar	kgf/cm <sup>2</sup>	atm	mmH <sub>2</sub> O	mmHg / Torr
1	1×10 <sup>-3</sup>	1×10 <sup>-6</sup>	1×10 <sup>-5</sup>	1.01972×10 <sup>-5</sup>	9.86923×10 <sup>-6</sup>	1.01972×10 <sup>-1</sup>	7.50062×10 <sup>-3</sup>
1×10 <sup>3</sup>	1	1×10 <sup>-3</sup>	1×10 <sup>-2</sup>	1.01972×10 <sup>-2</sup>	9.86923×10 <sup>-3</sup>	1.01972×10 <sup>2</sup>	7.50062
1×10 <sup>6</sup>	1×10 <sup>3</sup>	1	1×10	1.01972×10	9.86923	1.01972×10 <sup>5</sup>	7.50062×10 <sup>3</sup>
1×10 <sup>5</sup>	1×10 <sup>2</sup>	1×10 <sup>-1</sup>	1	1.01972	9.86923×10 <sup>-1</sup>	1.01972×10 <sup>4</sup>	7.50062×10 <sup>2</sup>
9.80665×10 <sup>4</sup>	9.80665×10	9.80665×10 <sup>-2</sup>	9.80665×10 <sup>-1</sup>	1	9.67841×10 <sup>-1</sup>	1×10 <sup>4</sup>	7.35559×10 <sup>2</sup>
1.01325×10 <sup>5</sup>	1.01325×10 <sup>2</sup>	1.01325×10 <sup>-1</sup>	1.01325	1.03323	1	1.03323×10 <sup>4</sup>	7.60000×10 <sup>2</sup>
9.80665	9.80665×10 <sup>-3</sup>	9.80665×10 <sup>-6</sup>	9.80665×10 <sup>-5</sup>	1×10 <sup>-4</sup>	9.67841×10 <sup>-5</sup>	1	7.35559×10 <sup>-2</sup>
1.33322×10 <sup>2</sup>	1.33322×10 <sup>-1</sup>	1.33322×10 <sup>-4</sup>	1.33322×10 <sup>-3</sup>	1.35951×10 <sup>-3</sup>	1.31579×10 <sup>-3</sup>	1.35951×10	1

Hinweis: 1Pa=1N/m<sup>2</sup>

**● Kraft**

N	dyn	kgf
1	1×10 <sup>5</sup>	1.01972×10 <sup>-1</sup>
1×10 <sup>-5</sup>	1	1.01972×10 <sup>-6</sup>
9.80665	9.80665×10 <sup>5</sup>	1

**● Beanspruchung**

Pa	MPa oder N/mm <sup>2</sup>	kgf/mm <sup>2</sup>	kgf/cm <sup>2</sup>
1	1×10 <sup>-6</sup>	1.01972×10 <sup>-7</sup>	1.01972×10 <sup>-5</sup>
1×10 <sup>6</sup>	1	1.01972×10 <sup>-1</sup>	1.01972×10
9.80665×10 <sup>6</sup>	9.80665	1	1×10 <sup>2</sup>
9.80665×10 <sup>4</sup>	9.80665×10 <sup>-2</sup>	1×10 <sup>-2</sup>	1

Hinweis: 1Pa=1N/m<sup>2</sup>

**● Arbeit / Energie / Hitzeleistung**

J	kW·h	kgf·m	kcal
1	2.77778×10 <sup>-7</sup>	1.01972×10 <sup>-1</sup>	2.38889×10 <sup>-4</sup>
3.600 ×10 <sup>6</sup>	1	3.67098×10 <sup>5</sup>	8.6000 ×10 <sup>2</sup>
9.80665	2.72407×10 <sup>-6</sup>	1	2.34270×10 <sup>-3</sup>
4.18605×10 <sup>3</sup>	1.16279×10 <sup>-3</sup>	4.26858×10 <sup>2</sup>	1

Hinweis: 1J=1W·s, 1J=1N·m  
1cal=4.18605J  
(Nach geltendem Recht über Gewichte und Maße)

**● Produktionsanteil / Antriebskraft / Hitzedurchflussverhältnis**

W	kgf·m/s	PS	kcal/h
1	1.01972×10 <sup>-1</sup>	1.35962×10 <sup>-3</sup>	8.6000 ×10 <sup>-1</sup>
9.80665	1	1.33333×10 <sup>-2</sup>	8.43371
7.355 ×10 <sup>2</sup>	7.5 ×10	1	6.32529×10 <sup>2</sup>
1.16279	1.18572×10 <sup>-1</sup>	1.58095×10 <sup>-3</sup>	1

Hinweis: 1W=1J/s, PS:Pferdestärke  
1PS=0.7355kW  
1cal=4.18605J  
(Nach geltendem Recht über Gewichte und Maße)

# INHALTSVERZEICHNIS

## INHALTSVERZEICHNIS FÜR WERKZEUGBEZEICHNUNG

A.....	2
B.....	2
C.....	2
D.....	2
F.....	2
G.....	2
H.....	2
J.....	2
K.....	2
L.....	2
M.....	3
N.....	3
P.....	3
R.....	3
S.....	3
T.....	3
V.....	4
W.....	4



# INHALTSVERZEICHNIS FÜR WERKZEUGBEZEICHNUNG

Bestellnummer	PRODUKTNAME	Seite	Bestellnummer	PRODUKTNAME	Seite
<b>A</b>					
AJS○○○○○T○○	Spannschraube	N003	HKY○○○L	L-Schlüssel	N002
AMS○	Spannpratze	N014	HKY○○○R	L-Schlüssel	N002
<b>B</b>					
BCP○○○○	Befestigungsfeder	N013	HKY○○○T	T-Schlüssel	N002
BOES101	Schrauben	N008	HKY○○○W	Schlüssel	N002
BRS○○○○	Spannschraube	N003	HSC○○○○○○	Spannschraube	N002, N008
<b>C</b>					
CA○○○○	Spannpratze	N014	HSC○○○○○○H	Schrauben	N008
CBS○○○	Spanbrecher	N016	HSCX○○○○○○H	Schrauben	N008
CBT○○○	Spanbrecher	N016	HSP05008C	Verriegelungsschraube	N003
CCK○○○	Spannpratze	N014	HSS○○○○○○	Spannschraube	N002
CCP○○○	Befestigungsfeder	N013	HY○	Schraube	N004
CCTC1	Spannpratze	N014	HY-A1	Schraube	N004
CK○○○○	Spannpratze	N014	HY-V1	Schraube	N004
CKW6	Spannpratze	N015	<b>J</b>		
CSF401260T	Spannschraube	N003	JFS-○	JUST FIT SLEEVE - SET Bezeichnung	M170
CS○○○○T	Spannschraube	N003	JFS○○○○○○○	JFS VERSTELLHÜLSE	M170
CS○○○○○○○T	Spannschraube	N003	JSS○	Schraube	N004
CS○○○○○○○○○T	Spannschraube	N003	<b>K</b>		
<b>D</b>					
DCK○○○○○	Spannpratze	N015	KGC1	Spannpratze	N015
DCSVN32	Unterlegplatte	N010	KS○○	Schrauben	N004
DC○○○○○T	Spannschraube	N003	KSN○	Spannschraube	N009
DFAS	DFAS-Bohrer	M020–M022	KSN3	Mini-Einstellmutter	N009
DKS○	Spannschraube	N003	KS○S	Schrauben	N004
DLE○○○○○S○○○P○○○	DLE-Zentrierbohrer	M012, M013	KSS2	Große Einstellschraube	N009
DSAS○○○○○X○○○S○○○	DSAS-Bohrer	M092–M096	<b>L</b>		
DVAS○○○○○X○○○S○○○	DVAS-Bohrer	M033–M036	LK1	Spannpratze	N015
DWAE○○○○○X○○○S○○○	MINI-DWAE Bohrer	M024	LLCL○○○○	Kniehebel	N013
DWAE○○○○○X○○○S○○○	DWAE-Bohrer	M025–M030	LLCL○○○S	Kniehebel	N013
<b>F</b>					
FC400890T	Spannschraube	N003	LLCS○○○○	Spannschraube	N004
<b>G</b>					
GY05016S	Spannschraube	N003	LLCS○○○○○S	Spannschraube	N004
GY06013M	Spannschraube	N003	LLP○○○	Befestigungsfeder	N013
<b>H</b>					
HBH○○○○○○	Spannschraube	N002	LLR○	Radialschraube	N004
HBHA○○○○○○	Spannschraube	N002	LLSCN○○	Unterlegplatte	N010
HDS○○○○○○	Spannschraube	N008	LLSCN○○○T	Unterlegplatte	N010
HFF080○○○H	Spannschraube	N008	LLSCP○○	Unterlegplatte	N010
HKY○○○D	Schlüssel	N002	LLSDN○○	Unterlegplatte	N010
HKY○○○F	Schlüssel	N002	LLSDP42	Unterlegplatte	N010
			LLSRN○○○○	Unterlegplatte	N010
			LLSSN○○	Unterlegplatte	N010
			LLSSP42	Unterlegplatte	N010
			LLSTE32	Unterlegplatte	N010
			LLSTN○○	Unterlegplatte	N010
			LLSTP○○	Unterlegplatte	N010
			LLSWN○○○○	Unterlegplatte	N010
			LLSWN○○○T	Unterlegplatte	N010
			LLSWP○○	Unterlegplatte	N010
			LS○	Spannschraube	N004
			LS○○	Spannschraube	N004

Bestellnummer	PRODUKTNAME	Seite	Bestellnummer	PRODUKTNAME	Seite
LS00T	Spannschraube	N004	<b>N</b>		
LS0000T	Spannschraube	N004	NS000	Spannschraube	N005
LS10TS	Spannschraube	N004	NS000W	Spannschraube	N005
<b>M</b>			<b>P</b>		
MAE0000MB	MAE-Bohrer (Externe Kühlung)	M122–M126	PO0S	Fixierstift	N014
MAS0000LB/MB	MAS-Bohrer (Interne Kühlung)	M122–M126	PS00	Unterlegplatte	N010
MBA00000H	Spannschraube	N008	PT00	Unterlegplatte	N010
MCA	MCA-Bohrer	M187	PT00TOR	Unterlegplatte	N011
MCAH	MCAH-Bohrer	M191	PO00US	Fixierstift	N014
MCC	MCC-Bohrer	M186	PV000	Unterlegplatte	N011
MCCH	MCCH-Bohrer	M190	PO00W	Fixierstift	N014
MCT	MCT-Bohrer	M188	PO00WS	Fixierstift	N014
MCW	MCW-Bohrer	M189	<b>R</b>		
MFE	MINI-MFE Bohrer	M018	RKY00S	Schlüssel	N002
MGS6	Spannschraube	N005	RS0000T	Spannschraube	N005
MGS0000L000B	MIKRO MGS Bohrer	M075	RX1S00000H7D0TP0	Kopf	M195, M196
MHS0000L000B	MHS-Bohrer	M128–M135	RX1SX00S00ATP0	Halter	M197
MHS532R	Unterlegplatte	N011	RX1ST00TP00	Spannschraube	M197
MHT1	Spannschraube	N005	<b>S</b>		
MK1K	Kupferpasten	N017	S0	Spannschraube	N005
MK1KS	Kupferpasten	N017	SD00	Schrauben	N005
MLCP42	Unterlegplatte	N011	SETK00	Spannpratze	N015
MLDP42	Unterlegplatte	N011	SETS00	Spannschraube	N005
MLSP42	Unterlegplatte	N011	SLCS000	Spannschraube	N005
MLTP32	Unterlegplatte	N011	SOMX0000000000	WSP (Für MVX-Bohrer)	M166
MMS0000S/L-DIN	MMS-Bohrer	M078–M089	SPSVN32	Unterlegplatte	N011
MMS0000S/L-DIN-C	MMS-Bohrer	M078–M089	SPS1	Lokatorschraube	N005
MMS0000X0DB	MMS-Bohrer	M078–M089	SRK1R	Spannpratze	N015
MNS0000LB/X00DB	MNS-Bohrer	M098–M115	SRS5	Spannschraube	N005
MNS0000L0C/L00C	MNS-Bohrer	M098–M115	STASX0000N	Unterlegplatte	N012
MNS0000S/L-DIN	MNS DIN6537 (Schaft mit Whistle Notch)	M098–M117	STAW0N0000S00	STAW-Bohrer	M139–M141
MNS0000S/L-DIN-C	MNS DIN6537 (Zylind. Schaft)	M098–M117	STAWN0000T	WSP (Für STAW-Bohrer)	M143
MP6	Befestigungsfeder	N013	STAWN0000TH	WSP (Für STAW-Bohrer)	M142, M143
MPS1-0000L0C/L00C	MPS1-Bohrer	M057–M071	STAW0S0000S00	STAW-Bohrer	M139–M141
MPS1-0000PC	MPS1- Pilotbohrer	M057–M071	<b>T</b>		
MPS1-0000S/L-DIN	MPS1 DIN6537 (Schaft mit Whistle Notch)	M057–M071	TAWNH0000T	WSP (Für TAW Bohrer)	M153, M154
MPS1-0000S/L-DIN-C	MPS1 DIN6537 (Zylind. Schaft)	M057–M071	TAW0N0000S00	TAW-Bohrer (Allg. Anwendung)	M148–M152
MSCN63	Unterlegplatte	N011	TIP000	Schlüssel	N002
MSE0000SB	MSE-Bohrer	M008, M009	TKY00D	Schlüssel	N002
MSP0300SB	MSP-Zentribohrer	M011	TKY00F	Schlüssel	N002
MSSN63	Unterlegplatte	N011	TKY00L	Schlüssel (lang)	N002
MTK0R/L	Spannpratze	N015	TKY00R	L-Schlüssel	N002
MVS0000X0S000	MINI-MVS-Bohrer	M049, M050	TKY00T	T-Schlüssel	N002
MVX0000X0F00	MVX-Bohrer	M158–M165	TKY00W	Schlüssel	N002
MWS0000SB/LB/XB	MINI-MWS Bohrer	M053, M054	TPS0	Spannschraube	N007

# INHALTSVERZEICHNIS FÜR WERKZEUGBEZEICHNUNG

Bestellnummer	PRODUKTNAME	Seite	Bestellnummer	PRODUKTNAME	Seite
TPS○○○	Spannschraube	N007			
TPS○○○○	Spannschraube	N007			
TPS○○○○○	Spannschraube	N007			
TPS○○○-1	Spannschraube	N007			
TS○	Spannschraube	N006			
TS○○	Spannschraube	N006			
TS○○○	Spannschraube	N006			
TS○○○○	Spannschraube	N006			
TSS○○○○○	Radial Schraube	N007			
TSS○○○○○S	Spannschraube	N007			
<b>V</b>					
VAPDM	VIOLET Bohrer	M177–M179			
VAPDS	VIOLET Bohrer	M172–M175			
VAPDSCB	VIOLET Bohrer	M183, M184			
VSD	VIOLET Bohrer, Zyl. Schaft	M181, M182			
<b>W</b>					
WCS○○○○○○○H	Schraube	N007			
WPSTN○○	Unterlegplatte	N012			
WPSWC43	Unterlegplatte	N012			
WPSWN43	Unterlegplatte	N012			
WPT4405	Schlitz-Reiniger (Für TAW-Bohrer)...	M148–M152			
WS○○○○○○○T	Spannschraube	N007			
WS○○○○○○○TPS	Spannschraube	N007			

1 INHALTSVERZEICHNIS

# WELTWEIT



## **MITSUBISHI MATERIALS - METALWORKING SOLUTIONS COMPANY GEMEINSAM ZUM ERFOLG**

Der Geschäftsbereich Metalworking Solutions des Mitsubishi Materials Konzerns widmet sich der Herstellung und Bearbeitung von Metallen, Schneidstoffen, Beschichtungen und Präzisionswerkzeugen. Mit fundiertem Know-how und langjähriger Erfahrung in der Fertigungstechnik gehört Mitsubishi Materials zu den führenden Anbietern in diesem Marktsegment.

Die globale Marktpräsenz des Unternehmens mit Hauptgeschäftsstellen und Vertriebsgesellschaften in Japan, Europa, Indien, Brasilien, China, Thailand, Mexiko und den USA sowie mit einem breiten Netzwerk von internationalen Handelspartnern sorgt für einen flächendeckenden, zielgerichteten Service.

Informationsaustausch und Technologietransfer, offene Kommunikation und wachsende Synergien über Grenzen hinweg garantieren maximale Leistung und einen dauerhaften Kundenerfolg.

# METALWORKING SOLUTIONS COMPANY

---

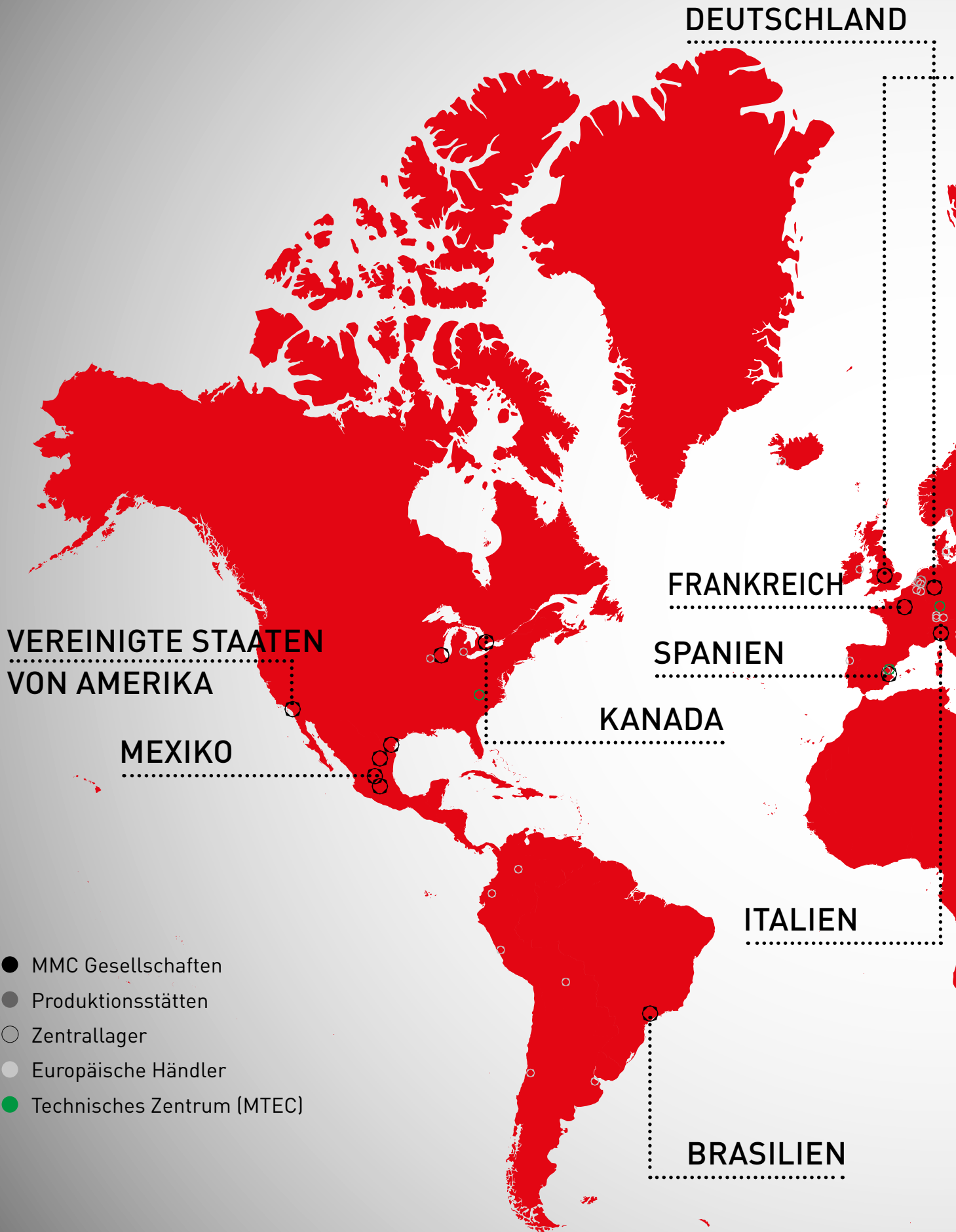



POLEN

U.K.

JAPAN

CHINA

THAILAND

INDIEN

TÜRKEI





## EUROPÄISCHE VERTRIEBSGESELLSCHAFTEN

### GERMANY

MMC HARTMETALL GMBH  
Comeniusstr. 2 . 40670 Meerbusch  
Phone +49 2159 91890 . Fax +49 2159 918966  
Email admin@mmchg.de

### UK Office

MMC HARDMETAL UK LTD  
1 Centurion Court, Centurion Way  
Tamworth, B77 5PN  
Phone +44 1827 312312  
Email sales@mitsubishicarbide.co.uk

### UK Deliveries/Returns

Unit 4 B5K Business Park, Quartz Close  
Tamworth, B77 4GR

### SPAIN

MITSUBISHI MATERIALS ESPAÑA, S.A.  
Calle Emperador 2 . 46136 Museros/Valencia  
Phone +34 96 1441711  
Email comercial@mmevalencia.es

### FRANCE

MMC METAL FRANCE S.A.R.L.  
6, Rue Jacques Monod . 91400 Orsay  
Phone +33 1 69 35 53 53 . Fax +33 1 69 35 53 50  
Email mmfsales@mmc-metal-france.fr

### POLAND

MMC HARDMETAL POLAND SP. Z O.O  
Al. Armii Krajowej 61 . 50-541 Wrocław  
Phone +48 71335 1620 . Fax +48 71335 1621  
Email sales@mitsubishicarbide.com.pl

### ITALY

MMC ITALIA S.R.L.  
Viale Certosa 144 . 20156 Milano  
Phone +39 0293 77031 . Fax +39 0293 589093  
Email info@mmc-italia.it

### TURKEY

MMC HARTMETALL GMBH ALMANYA - İZMİR MERKEZ ŞUBESİ  
Adalet Mahallesi Anadolu Caddesi No: 41-1 . 15001 35530 Bayraklı / İzmir  
Phone +90 232 5015000 . Fax +90 232 5015007  
Email info@mmchg.com.tr

[www.mmc-carbide.com](http://www.mmc-carbide.com)



C010D

Veröffentlicht durch: MMC Hartmetall GmbH – A Sales Company of  MITSUBISHI MATERIALS | 2025.04